

PIP SIZE	P.D.L SYMBOL	FIXTURE UNIT RATINGS	A SIZE	B SIZE
1/2"	A	1 - 11	5"	1/2"
3/4"	B	12 - 32	5"	3/4"
1"	C	33 - 60	7"	1"
1-1/4"	D	61 - 113	8"	1-1/4"
1-1/2"	E	114 - 134	8"	1-1/2"
2"	F	155 - 330	9"	2"

NOTE: SHOCK ABSORBERS TO BE LOCATED ON EACH SUPPLY BRANCH THAT CONTAINS A FAST-ACTING VALVE (FLUSH VALVE, DISHWASHER, ICE MAKER, WASHING MACHINE, ETC.)

9 WATER SHOCK ARRESTOR DETAIL
NOT TO SCALE

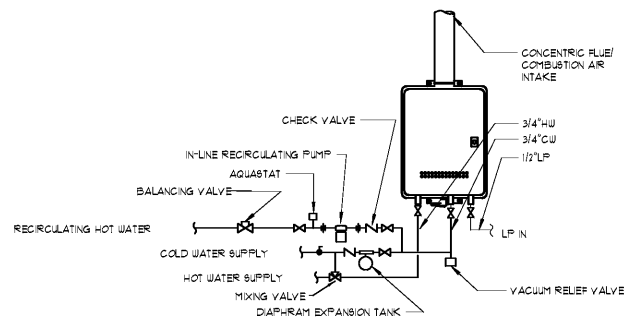

10 TANKLESS WATER HEATER DETAIL
NOT TO SCALE

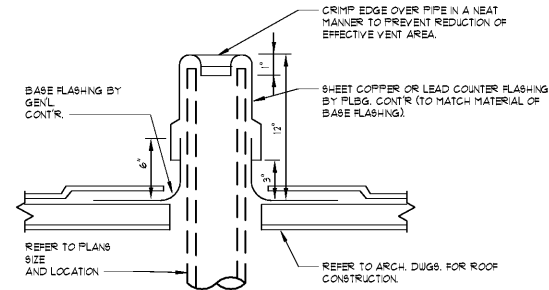

5 PLUMBING VENT THROUGH FLAT ROOF DETAIL
NOT TO SCALE

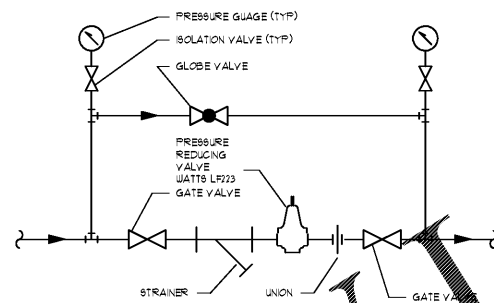

6 PRESSURE REDUCING VALVE STATION
NOT TO SCALE

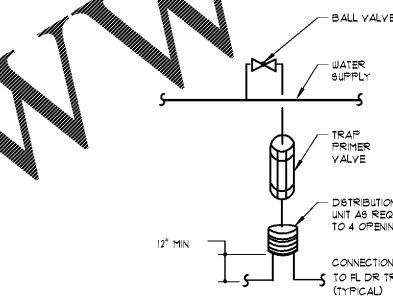

7 TRAP PRIMER DETAIL
NOT TO SCALE

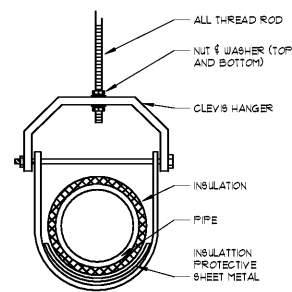

8 TYPICAL CLEVIS HANGER DETAIL
NOT TO SCALE

NOTE
GAS METER & REGULATOR SHALL BE BY THE LOCAL GAS COMPANY. ALL COSTS WILL BE INCURRED BY THE PLUMBING CONTRACTOR.

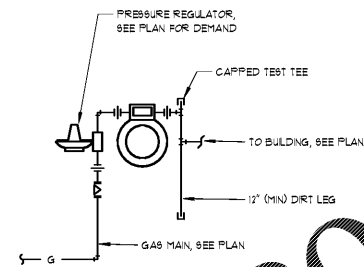

1 GAS METER DETAIL
NOT TO SCALE

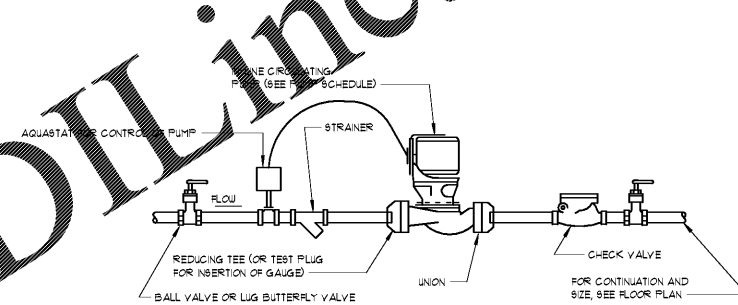

2 IN-LINE CIRCULATING PUMP DETAIL
NOT TO SCALE

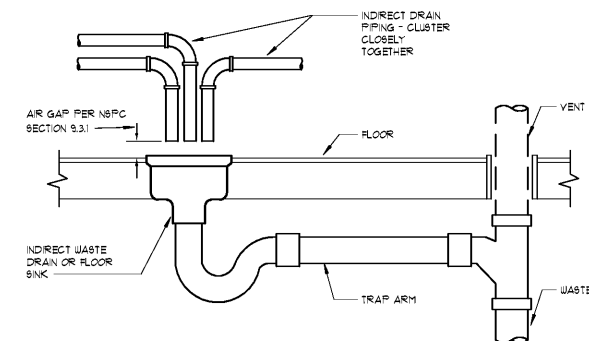

3 INDIRECT WASTE DRAIN DETAIL
NOT TO SCALE

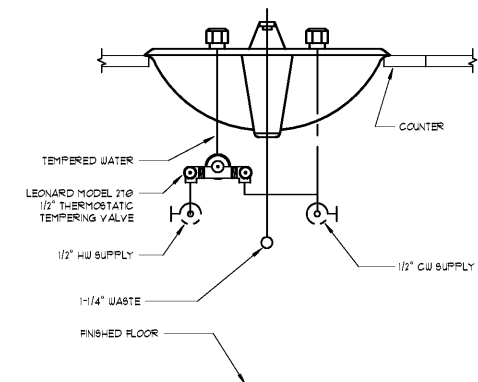

4 LOCAL MIXING VALVE DETAIL
NOT TO SCALE



126 TICHENOR AVE
AUBURN, AL 36830
334.887.7010

IN ASSOCIATION WITH:



SEALS & SIGNATURES:

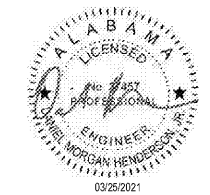

REV	DESCRIPTION	DATE

101 N COLLEGE STREET

101 N. COLLEGE STREET
AUBURN, AL 36830



Project No.: SNA Project #: 2021-04
Client Project No.: 210000X

Drawing Title: DETAILS - PLUMBING

Date: 03/25/2021 Phase:
Designed: Designer
Drawn: Author
Checked: Checker

P0.2

Order Plans @