

Order Plans @ WWW.WLDLINE.COM

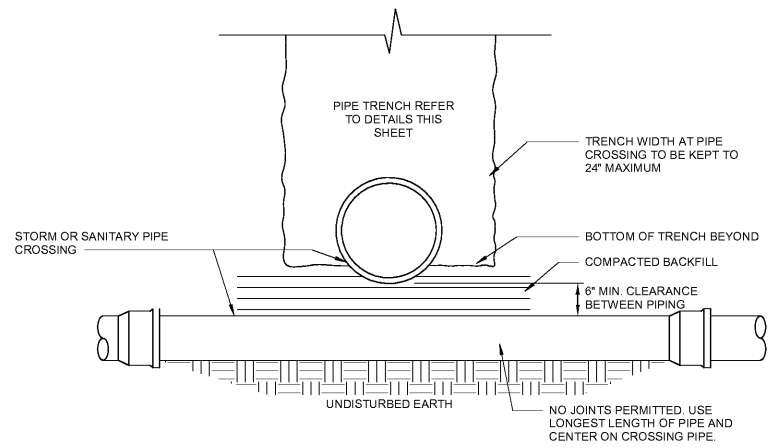

4 DETAIL - UNDERGROUND PIPE CROSSING
P3.2 N.T.S.

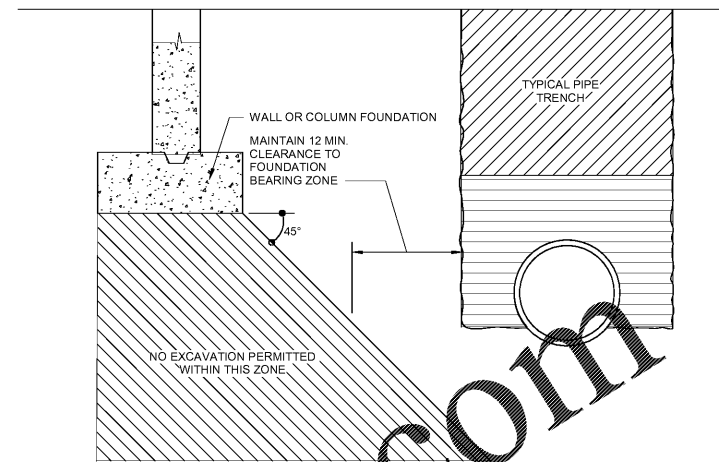

1 DETAIL - PIPE TRENCH LOCATION
P3.2 N.T.S.

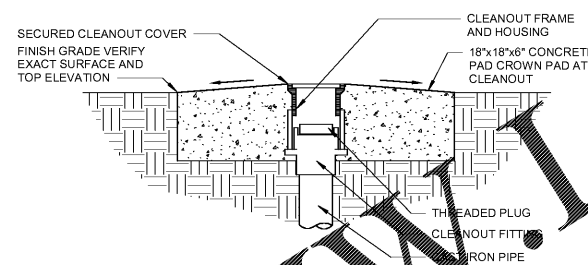

- NOTES:
- WHERE CLEANOUTS LOCATED IN SIDEWALL, CONCRETE PAD IS NOT REQUIRED. COORDINATE CLEANOUT LOCATION WITH ARCHITECTURAL/LANDSCAPING SURFACE FINISH & DESIGN.
 - IN PAVED AREAS PROVIDE EXTRA HEAVY DUTY FRAME AND COVER.

5 DETAIL - GRADE CLEANOUT (GCO)
P3.2 N.T.S.

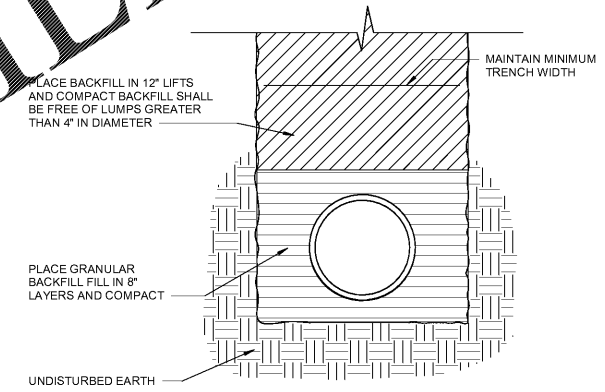

2 DETAIL - FLEXIBLE PIPE BEDDING
P3.2 N.T.S.

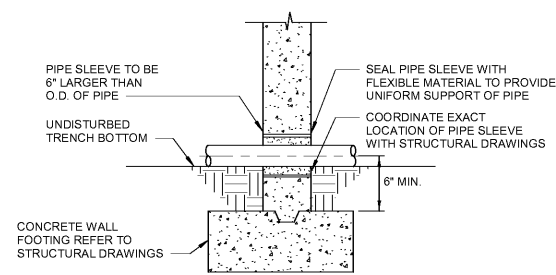

6 DETAIL - FOUNDATION WALL PIPE SLEEVE
P3.2 N.T.S.

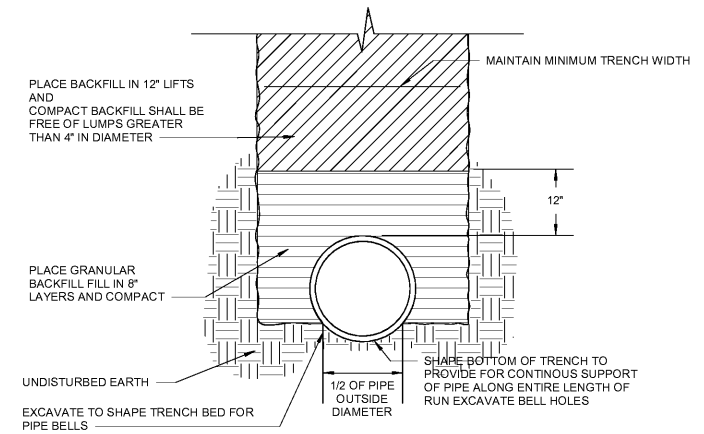

3 DETAIL - RIGID PIPE BEDDING
P3.2 N.T.S.

JOB NUMBER: 19221
CHECKED BY: Checker

PLANNING
ARCHITECTURE
INTERIORS

CALBERT
DESIGN GROUP

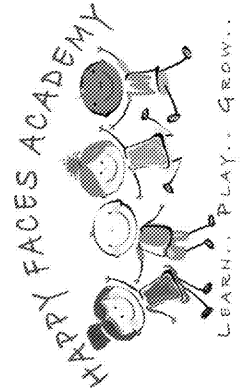

PROJECT LOCATION:
2865 WEBB ROAD
MILTON, GA 30004

REVISIONS		
NO	DATE:	DESCRIPTION:

THOMPSON EHLE CO.
50 TECHNOLOGY PKWY
PEACHTREE CORNERS, GA 30092
Tel: 404-266-1400
TEC #22021

DETAILS - PLUMBING

P3.2
DATE 06/24/20