

DRIVEWAY TRAFFIC FLOW DIRECTIONAL ARROW
NOT TO SCALE

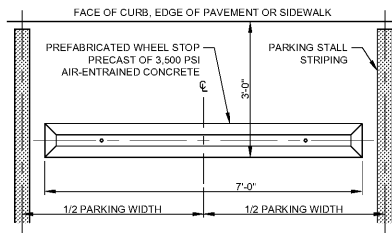

CONCRETE WHEEL STOP
NOT TO SCALE

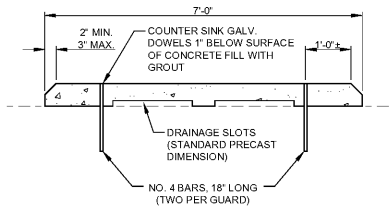
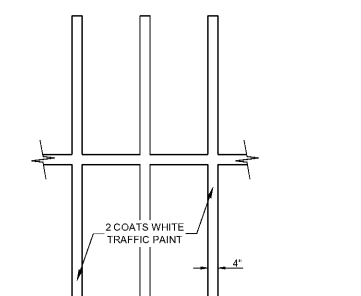

PAVEMENT STRIPING
NOT TO SCALE

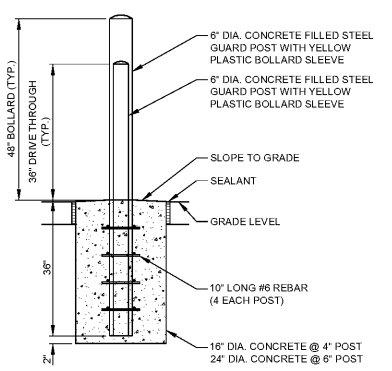

BOLLARD
NOT TO SCALE

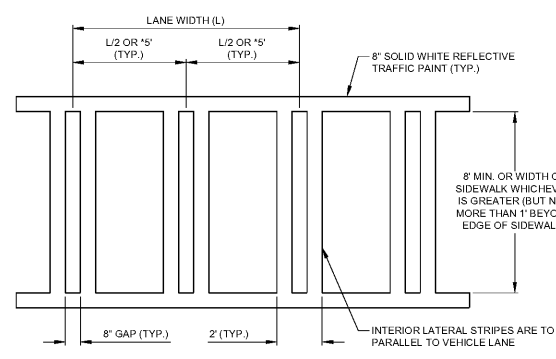

CROSSWALK STRIPING
NOT TO SCALE

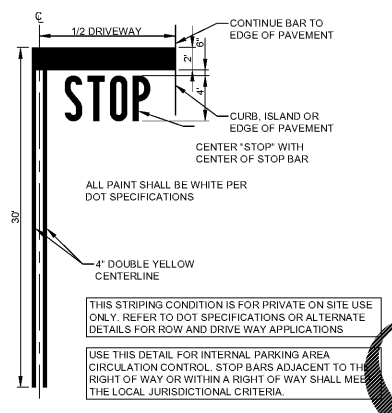

STOP BAR AND LABEL STRIPING
NOT TO SCALE

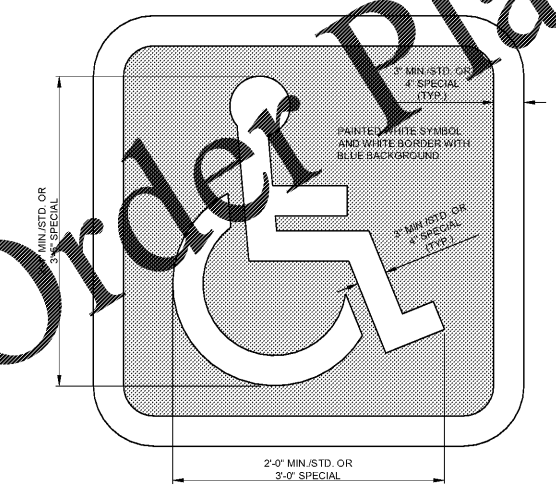

INTERNATIONAL SYMBOL OF ACCESSIBILITY PARKING SPACE MARKING
NOT TO SCALE

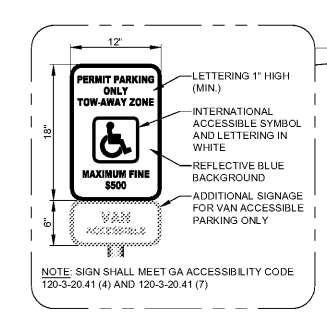

BOLLARD ACCESSIBLE SIGNAGE
NOT TO SCALE

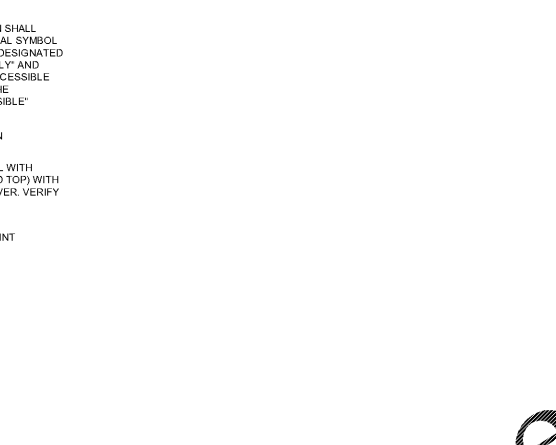
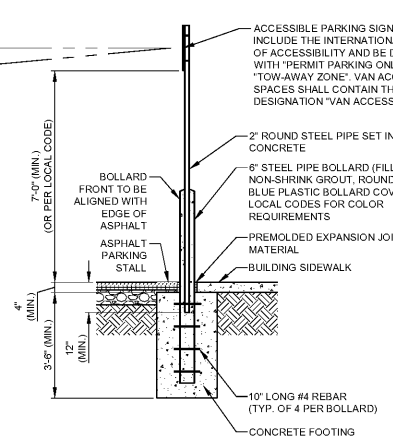

6\"/>



6\"/>

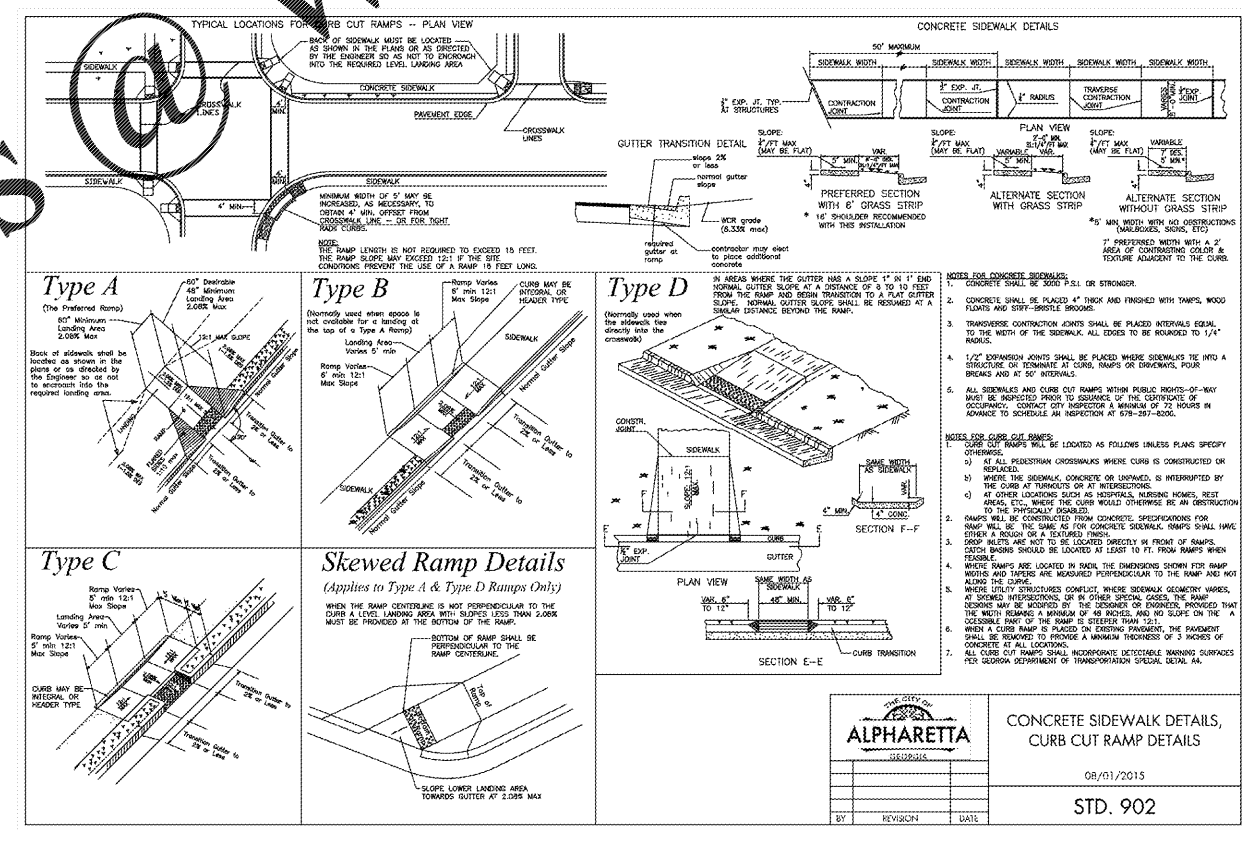

		CONCRETE SIDEWALK DETAILS, CURB CUT RAMP DETAILS	
		OR/01/2015	
		STD. 902	
BY	REVISION	DATE	



ENGINEER:

FORESITE group

Foresite Group, Inc.
3740 Davinci Ct.
Suite 100
Peachtree Corners, GA 30092

w | www.fg-inc.net
o | 770.368.1399
f | 770.368.1944

DEVELOPER:

JAI RADHE KRISHNA ENTERPRISES, LLC
568 PEACHTREE PARKWAY
CUMMING, GA 30041

CONTACT: RUPESH MANUGULA

PROJECT:

DAY CARE FACILITY - WEBB ROAD

2865 WEBB ROAD
MILTON, GA 30004
ILL. 1048, 2ND DISTRICT, 2ND SECTION
PARCEL #22 527010482814, FULTON CO PERMIT # 20-050WR

SEAL:

REVISIONS	DATE
ENVIRONMENTAL HEALTH	08-12-2020
CITY COMMENTS	10-7-2020
PROJECT MANAGER:	JPS
DRAWING BY:	JCW
JURISDICTION:	MILTON, GA
DATE:	07-15-2020
SCALE:	AS SHOWN
TITLE:	

CONSTRUCTION DETAILS

SHEET NUMBER: **C-6**

COMMENTS: NOT RELEASED FOR CONSTRUCTION

JOB/FILE NUMBER: 1418.001