

Lancaster County, South Carolina
Heath Springs Soccer Complex
200 Boyd Faile Road
Heath Springs, SC 29068

Revisions:

Proj. No.: 80703
Date: 10/13/2020

Sheet Name:
Grading, Erosion
& Sediment Control
Details

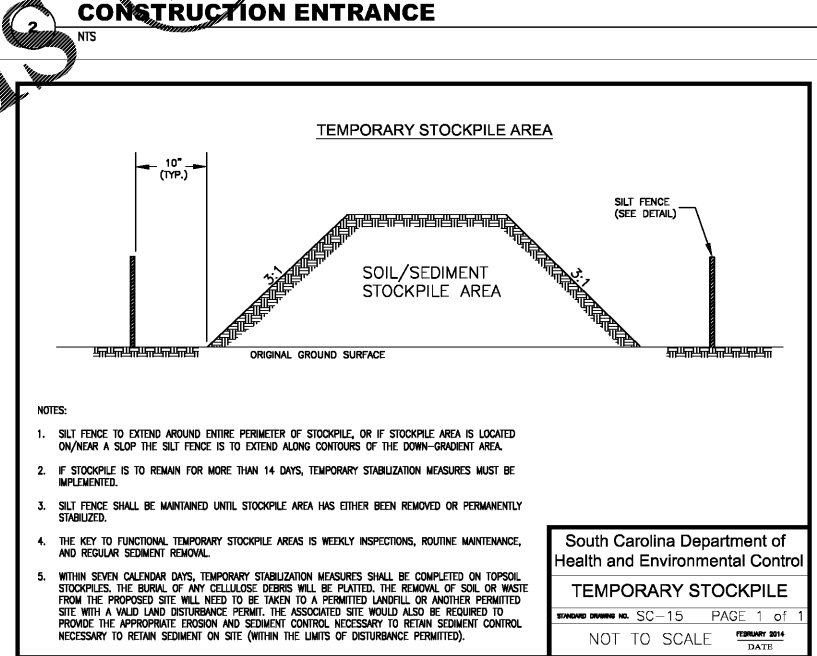
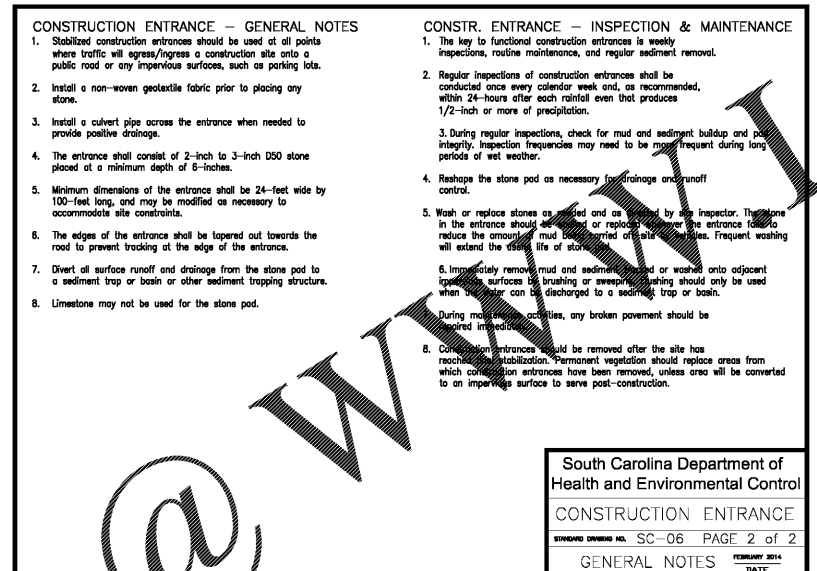
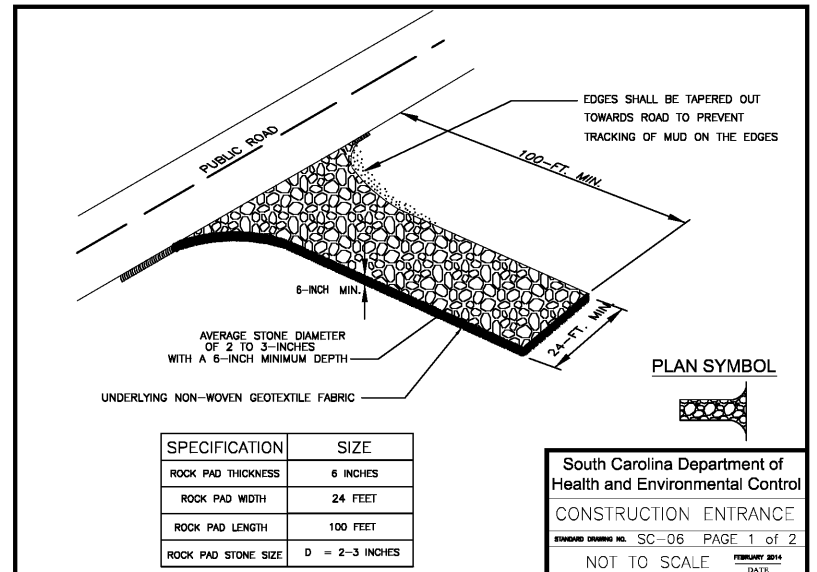
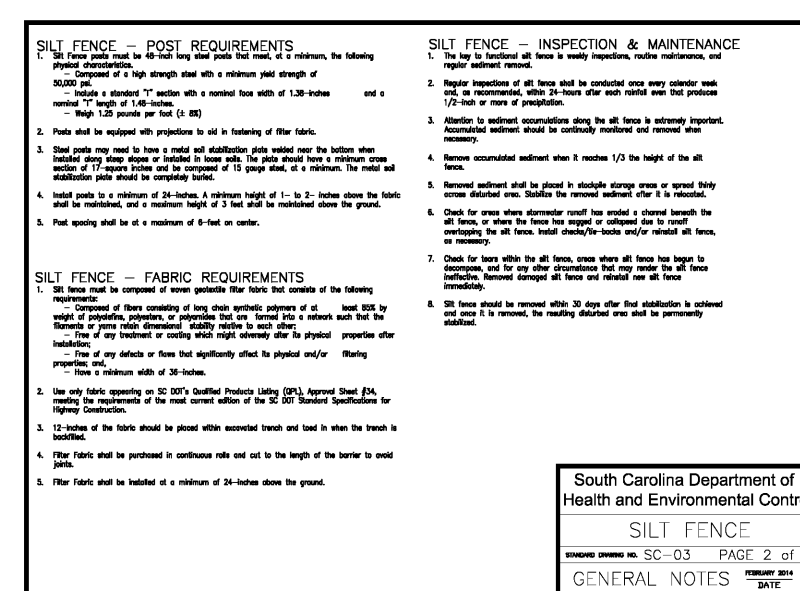
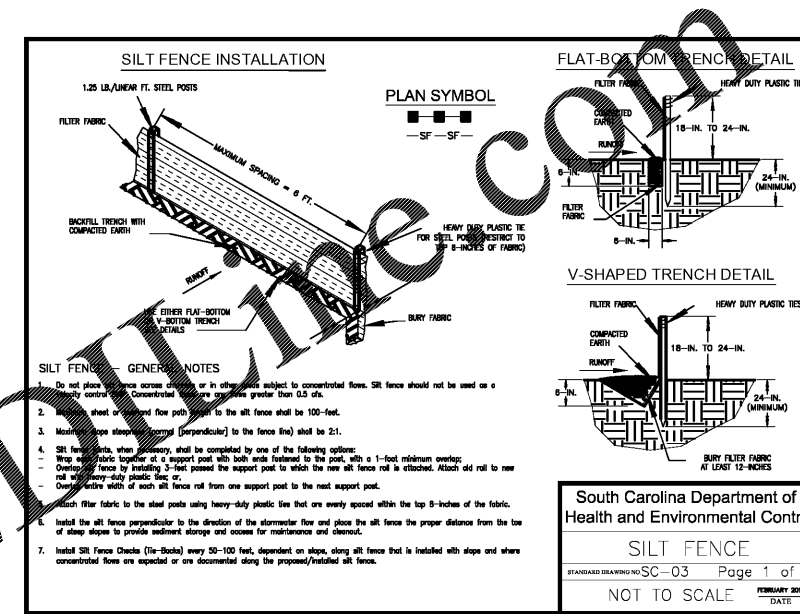

TEMPORARY STOCKPILE
N/S

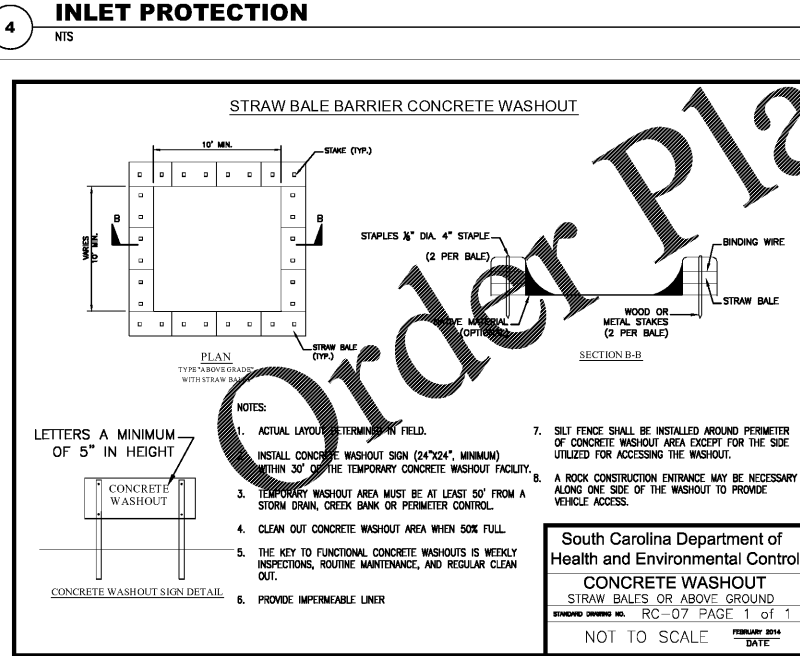
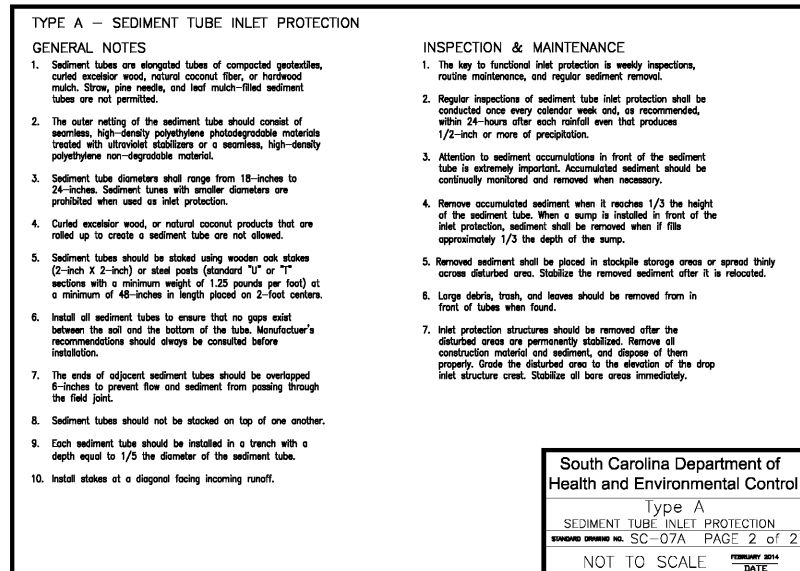
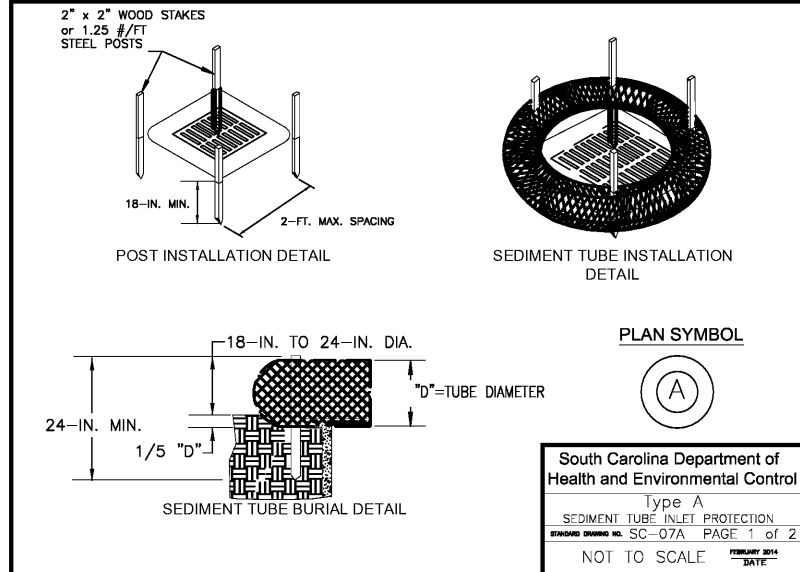

CONCRETE WASHOUT
N/S