

STATE	PROJECT NUMBER	SHEET NO.	TOTAL SHEETS
GA.			

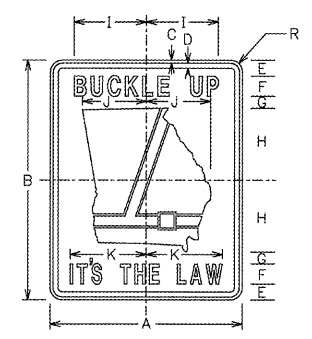

R560-1

SIGN	DIMENSIONS (INCHES)												
	A	B	C	D	E	F	G	H	I	J	K	R	
MIN & STD	30	36	1/2	3/4	2 1/2	3C	1 1/2	11	8 1/2	10	11	1 1/8	
FWY	48	60	3/4	1 1/4	4	5C	3	18	15 1/2	16	18	3	

**COLORS**  
 STATE SHIELD & BORDER - RED (REFL)  
 LEGEND & BELT - BLACK (NON-REFL)  
 BACKGROUND - WHITE (REFL)

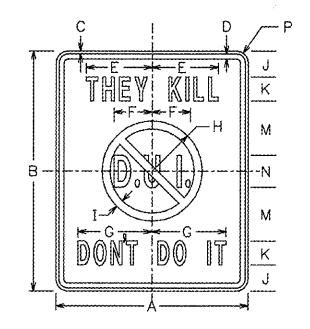
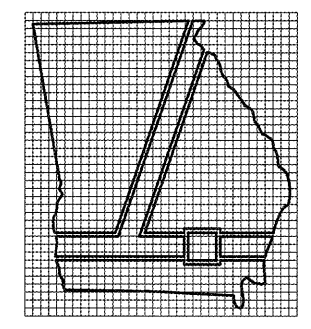

R560-2

SIGN	DIMENSIONS (INCHES)															
	A	B	C	D	E	F	G	H	I	J	K	L	M	N	P	
MIN & STD	30	36	1/2	3/4	11	5	12 1/2	7 1/2	1 1/4	4	4C	3	4 1/2	5C	1 7/8	
FWY	48	60	3/4	1 1/4	16 1/2	9 1/2	18 1/2	12 1/2	2	6 1/2	6C	5	8 1/2	8C	3	

**COLORS**  
 CIRCLE & DIAGONAL - RED (REFL)  
 LEGEND & BORDER - BLACK (NON-REFL)  
 BACKGROUND - WHITE (REFL)

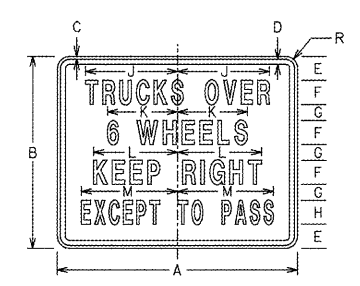

R560-3

SIGN	DIMENSIONS (INCHES)														
	A	B	C	D	E	F	G	H	J	K	L	M	R		
MIN & STD	36	30	1/2	3/4	3 1/2	3 1/2	C	3	3 1/2	8	14	10	11 1/2	14 1/2	1 7/8
FWY	60	48	3/4	1 1/4	6	6C	4	6B	23	17 1/2	21	24	3		

**COLORS**  
 LEGEND & BORDER - BLACK (NON-REFL)  
 BACKGROUND - WHITE (REFL)

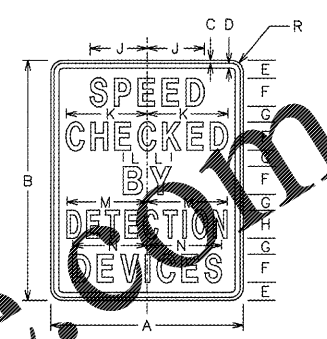

I550-1

SIGN	DIMENSIONS (INCHES)														
	A	B	C	D	E	F	G	H	J	K	L	M	N	R	
MIN & STD	30	36	1/2	3/4	4	4D	2	4C	8 3/8	11 3/8	3 1/8	11 1/8	10 3/8	1 3/8	
FWY	48	60	3/4	1 1/4	4 1/2	7D	4	7C	14 3/8	20 3/8	6	20	18 3/8	3	

**COLORS**  
 LEGEND & BORDER - BLACK (NON-REFL)  
 BACKGROUND - WHITE (REFL)

THE I550-1 SIGN SHALL BE ERECTED:

- ON EVERY HIGHWAY THAT COMPRISES A PART OF THE STATE HIGHWAY SYSTEM AT THAT POINT ON THE HIGHWAY WHICH INTERSECTS THE STATE LINE.
- AT THE TERMINI OF EVERY HIGHWAY THAT COMPRISES A PART OF THE STATE HIGHWAY SYSTEM WHICH BEGINS OR ENDS WITHIN THE STATE BOUNDARIES.
- ON EVERY HIGHWAY THAT COMPRISES A PART OF THE STATE HIGHWAY SYSTEM AT THAT POINT ON THE HIGHWAY WHERE TRAFFIC FROM OUTSIDE THE COUNTY FIRST ENTERS A COUNTY THAT HAS A PERMIT TO OPERATE SPEED DETECTION DEVICES, AND
- ON EVERY HIGHWAY THAT COMPRISES A PART OF THE STATE HIGHWAY SYSTEM AT THAT POINT ON THE HIGHWAY WHERE TRAFFIC FIRST ENTERS THE CORPORATE LIMITS OF ANY MUNICIPALITY THAT HAS A PERMIT TO OPERATE SPEED DETECTION DEVICES.

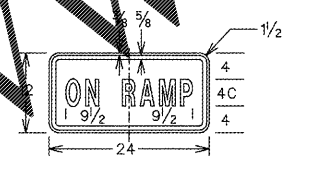

RB-3aP

**COLORS**  
 LEGEND & BORDER - RED (REFL)  
 BACKGROUND - WHITE (REFL)

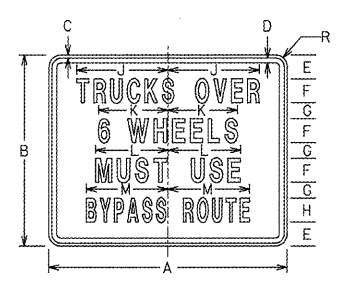

R560-4

SIGN	DIMENSIONS (INCHES)														
	A	B	C	D	E	F	G	H	J	K	L	M	R		
MIN & STD	36	30	1/2	3/4	3 1/2	3 1/2	C	3	3 1/2	8	14	10	10	12 1/2	1 7/8
FWY	60	48	3/4	1 1/4	6	6C	4	6C	23	17 1/2	17 1/2	25 1/2	3		

**COLORS**  
 LEGEND & BORDER - BLACK (NON-REFL)  
 BACKGROUND - WHITE (REFL)

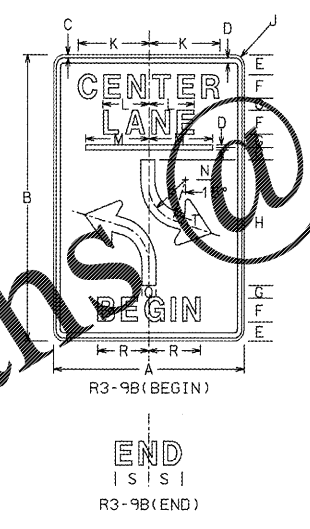

R3-9B(BEGIN)  
R3-9B(END)

SIGN	DIMENSIONS (INCHES)																		
	A	B	C	D	E	F	G	H	J	K	L	M	N	P	Q	R	S	T	
STD & MIN	24	36	3/8	5/8	2 1/2	3E	1 1/2	16	1 1/2	8 1/8	5 3/4	8	2 1/2	6	2	6 1/8	4 3/8	1 1/2	
SPECIAL	36	48	5/8	7/8	3 1/2	5E	1 1/2	20	2 1/4	14 1/8	9 1/2	12	3	8	3	7 1/8	4 5/8	2	

**COLORS**  
 LEGEND & BORDER - BLACK (NON-REFL)  
 BACKGROUND - WHITE (REFL)

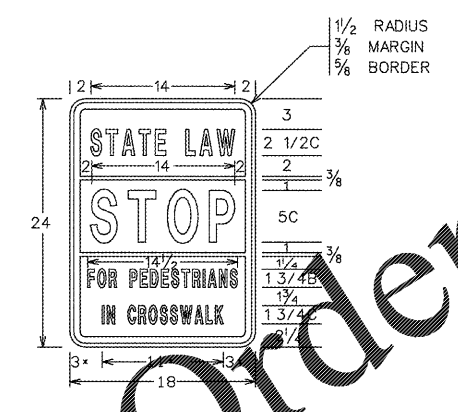

R560-5

**COLORS**  
 LEGEND & BORDER - BLACK (NON-REFL)  
 WORD "STOP" - RED (REFL)  
 BACKGROUND - WHITE (REFL)

DATE	REVISIONS	GEORGIA DEPARTMENT OF TRANSPORTATION OFFICE OF TRAFFIC SAFETY & DESIGN
5-24-00	ADDED R3-9 DETAIL	DETAILS OF REGULATORY SIGNS SHEET 1 OF 2
1-21-03	DELETED R1-4 SIGNS	
1-21-03	REV SIGN CODES FOR R3-9 SIGNS	
		NO SCALE
		JANUARY 2000