

REVISIONS	BY

**FREELAND and KAUFFMAN, INC.**  
 Engineers • Landscape Architects  
 209 West Stone Avenue  
 Greenville, South Carolina 29609  
 864-233-5497

**BD SET NOT FOR CONSTRUCTION**



**CALIBER COLLISION**  
 1233 E. BUTLER ROAD  
 GREENVILLE, SC 29607  
 CROSS DEVELOPMENT CC FIVE FORKS, LLC.  
 4936 MARSH RIDGE  
 CARROLLTON, TX 75010  
 TEL. (214) 614-8252

DRAWN	
CHECKED	
TMB	
DATE	01/04/2021
SCALE	

DRAWING  
 12

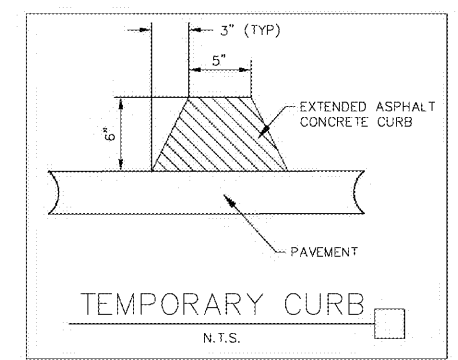
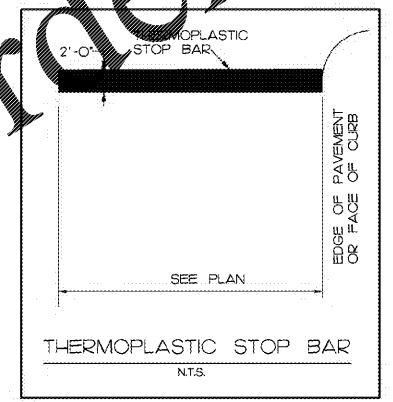
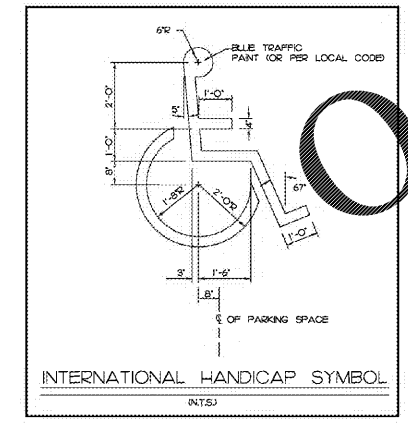
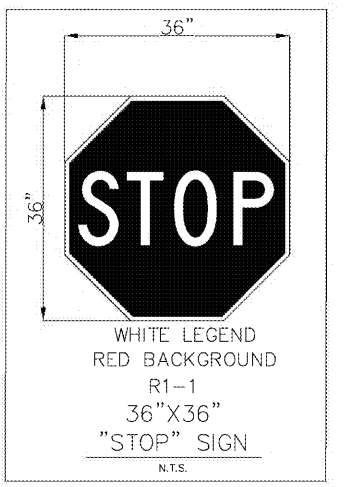
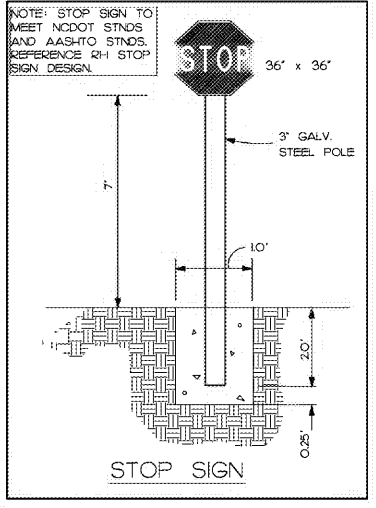
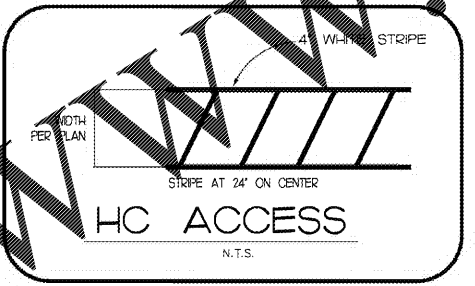
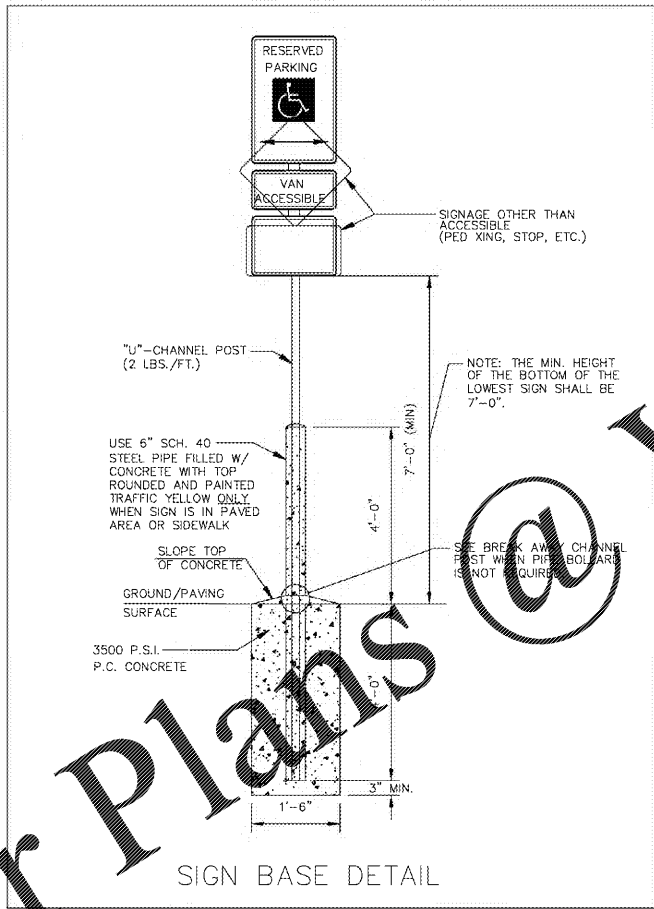
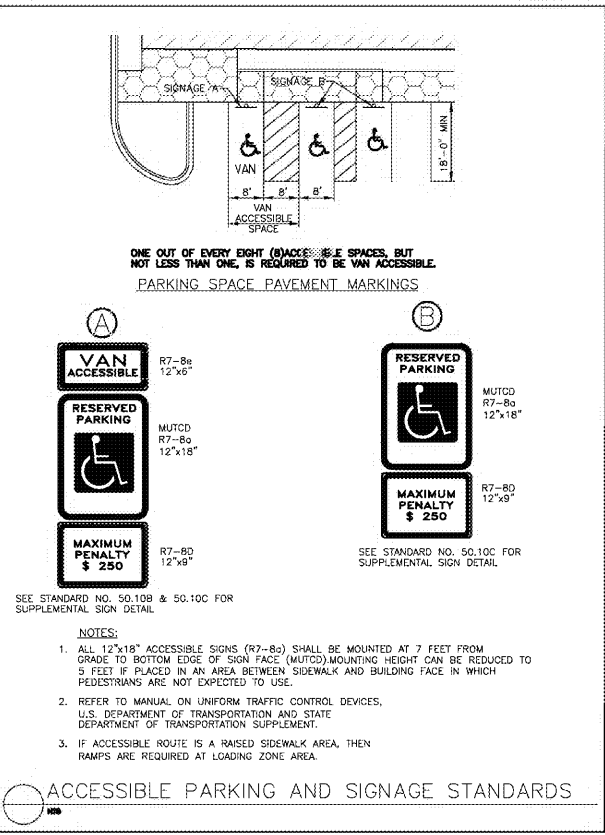
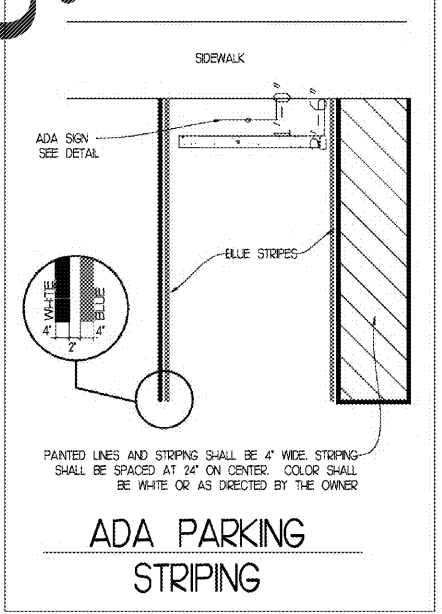
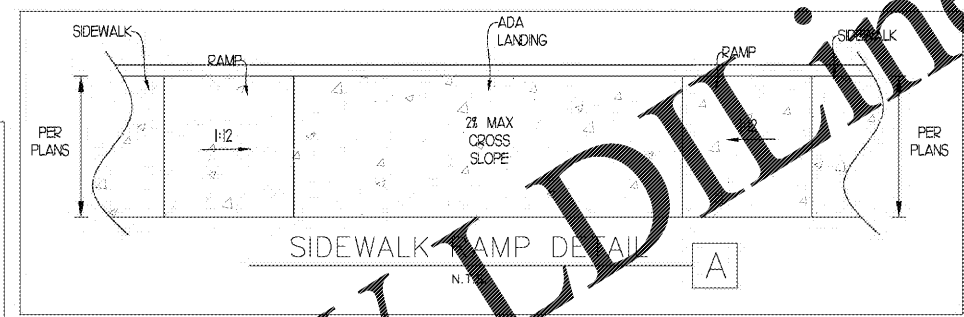
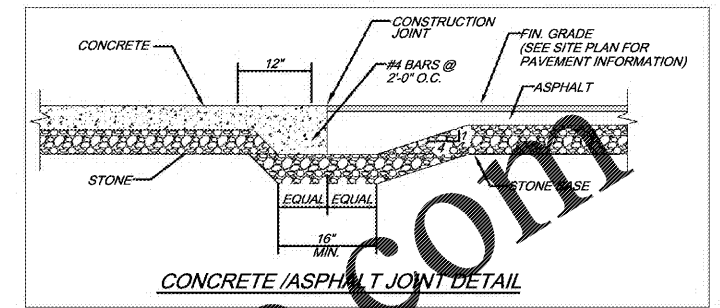
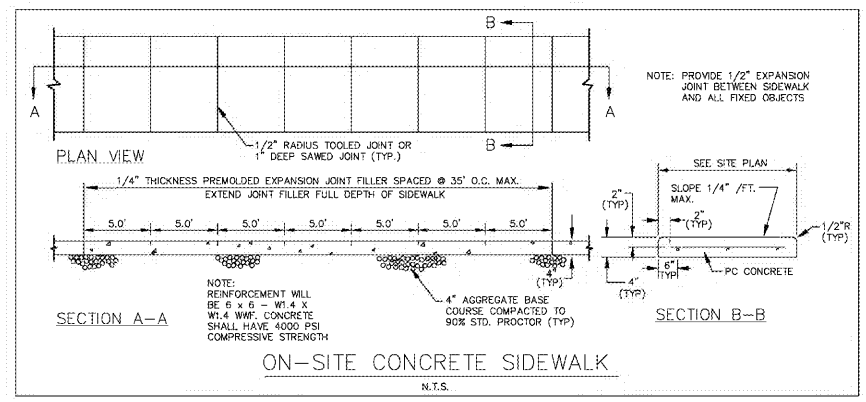
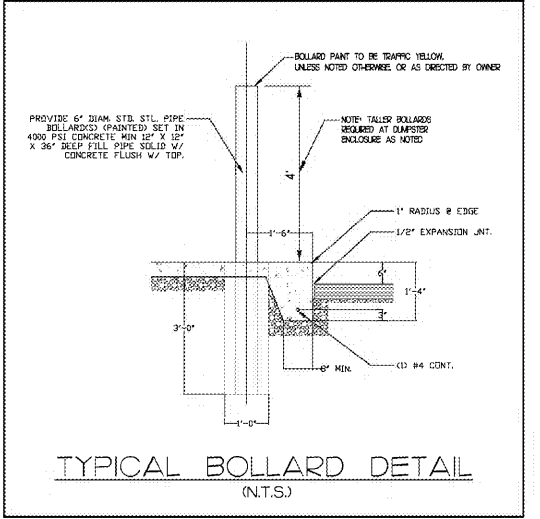
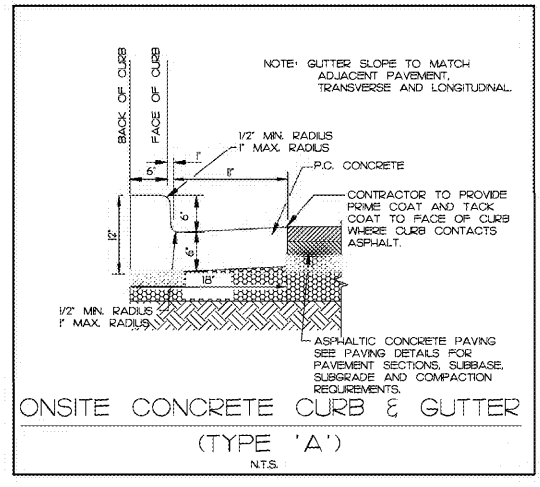

SITE DETAILS