

DRAWING INFORMATION		
DATE	DESCRIPTION	BY
10-28-20	PERMIT SET	JW

Engineering Professionals, Inc.
 812 N. W. 24th Street, Suite 201
 Tampa, FL 33603 (813) 237-6948

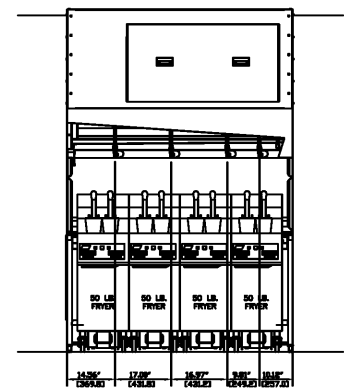

SHANE HAMILTON, P.E.
 912 W. MLK BLVD. TAMPA, FL
 GEORGIA LICENSE #PD41331



1 ANSUL FIRE SUPPRESSION PIPING DETAIL - OPTIONAL FRYER CONFIGURATION
 2 SCALE: NO SCALE

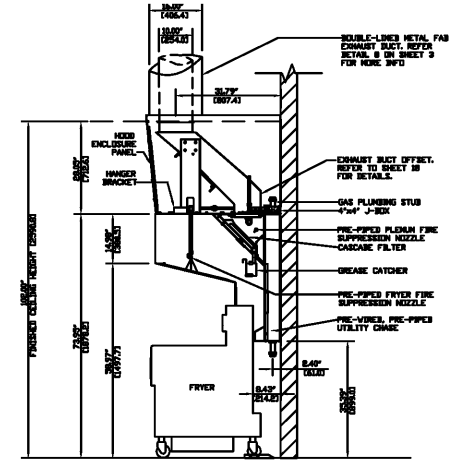

2 FRYER HOOD SECTION VIEW
 2 SCALE: NO SCALE

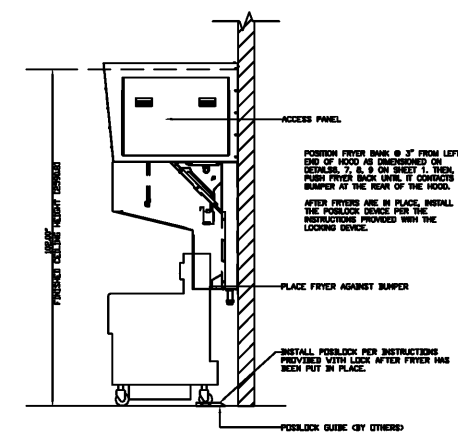

3 FRYER HOOD RIGHT END VIEW
 2 SCALE: NO SCALE

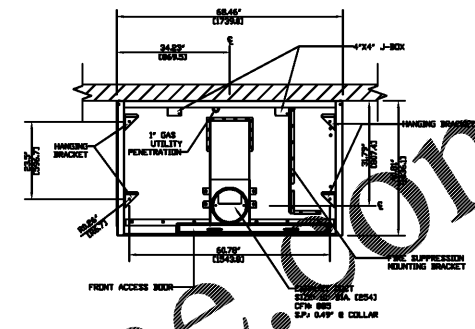

4 FRYER HOOD PLAN VIEW
 2 SCALE: NO SCALE

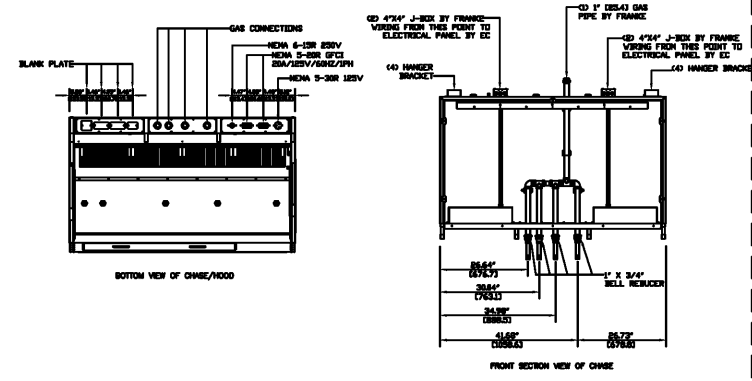

5 UTILITY DETAILS
 2 SCALE: NO SCALE

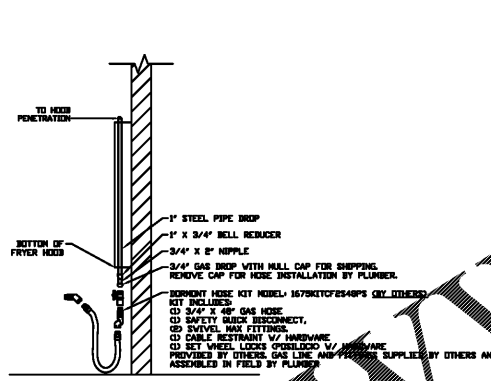

6 TYPICAL GAS FRYER UTILITY INSTALLATION
 2 SCALE: NO SCALE

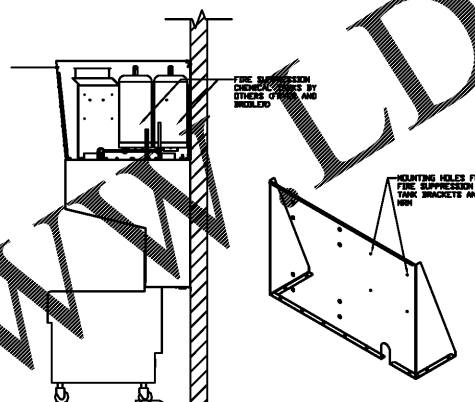

7 FIRE SYSTEM MOUNTING DETAIL
 2 SCALE: NO SCALE

AMEREX PIPING PART NUMBERS	
DUCT NOZZLE	PART #16416
PLENUM NOZZLE	PART #11982
FUSIBLE LINK	PART #18227
FRYER NOZZLES	PART #11982

NOTES:
 - ALL FUSIBLE LINKS ARE 360°
 - ALL BLOW OFF CAPS ARE HIGH TEMP METAL, PART #79745
 - PIPE DROPS, NOZZLES AND SWIVEL ELBOWS FURNISHED AND INSTALLED BY THE FIRE SYSTEM CONTRACTOR.

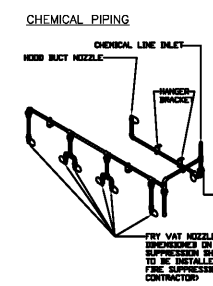

8 AMEREX FIRE SUPPRESSION ISOMETRIC DETAIL
 2 SCALE: NO SCALE

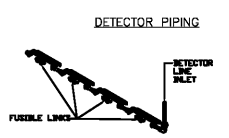

9 ANSUL FIRE SUPPRESSION ISOMETRIC DETAIL
 2 SCALE: NO SCALE

ANSUL PIPING PART NUMBERS	
DUCT NOZZLE	PART #4193372W
PLENUM NOZZLE	PART #4193351N
FUSIBLE LINK	PART #415742
FRYER NOZZLES	PART #41934024S

NOTES:
 - ALL FUSIBLE LINKS ARE 360°
 - ALL BLOW OFF CAPS ARE HIGH TEMP METAL, PART #12504
 - PIPE DROPS, NOZZLES AND SWIVEL ELBOWS FURNISHED AND INSTALLED BY THE FIRE SYSTEM CONTRACTOR.

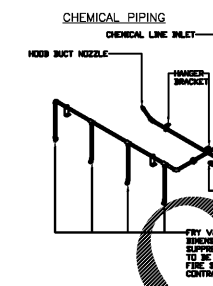

9 ANSUL FIRE SUPPRESSION ISOMETRIC DETAIL
 2 SCALE: NO SCALE

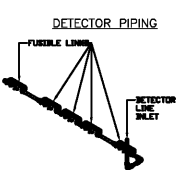

9 ANSUL FIRE SUPPRESSION ISOMETRIC DETAIL
 2 SCALE: NO SCALE

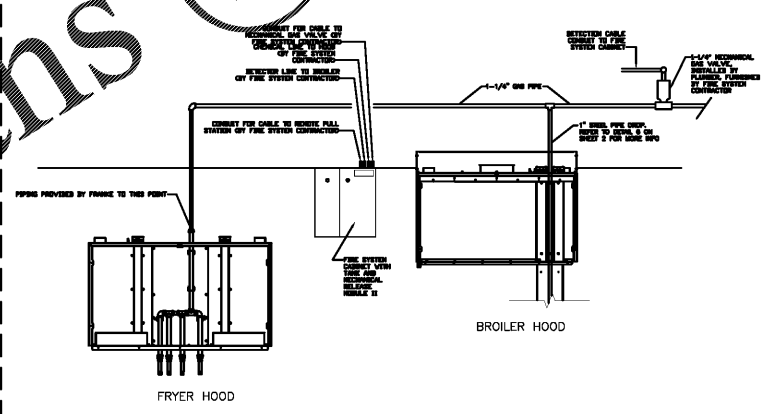

10 FIRE SUPPRESSION EXTERNAL CONTROL BOX DETAIL
 2 SCALE: NO SCALE

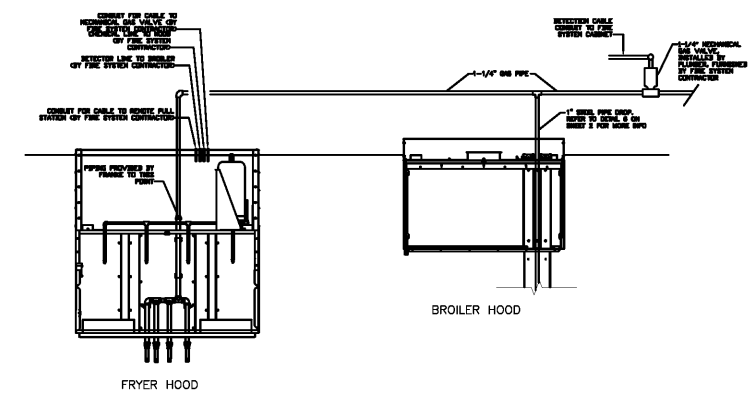

11 FIRE SUPPRESSION INTERNAL CONTROL BOX DETAIL
 2 SCALE: NO SCALE

*STANDARD MOUNTING OF THE FIRE SUPPRESSION SYSTEM INSIDE THE FRANKIE HOOD

*OPTIONAL MOUNTING OF THE FIRE SUPPRESSION SYSTEM OUTSIDE THE FRANKIE HOOD, ON THE WALL

PALMETTO BURGER KING
 3765 ROOSEVELT HWY, PALMETTO, GA.
 FOR: JP DESIGN & CONSTRUCTION
 JACKSON, GA

REVISIONS

SHEET TITLE: HOOD DETAILS

DATE: 10-30-20
 PROJECT NUMBER: 20-197
 SHEET NUMBER: M8

HVAC SYSTEM
NCA
 CONSULTANTS / GROUP
 6510 N. 125TH AVENUE, SUITE #1001
 LARGO, FLORIDA
 PHONE: (877) 530-0078
 CALL NCA MARKETING FOR PRICING
 NCA JOB# 20963

©Copyright 2020- Drawings, specifications, notes, database, computer files, field data, and reports as instruments of service prepared by the Design of Record. As instruments of service, these items remain the property of the Design of Record, who shall retain all statutory and other reserved rights, including the copyright thereto. Any use, reproduction or changes to these documents without written consent of NCA Consultants is a violation of federal copyright laws.