

DRAWING INFORMATION		
DATE	DESCRIPTION	BY
10-28-20	PERMIT SET	JW

Engineering Professionals, Inc.
Professional Engineers
112 N. W. 22nd Street, Suite 100
Tampa, FL 33603 (813) 271-6948

SHANE HAMILTON, P.E.
912 W. MLK BLVD. TAMPA, FL
GEORGIA LICENSE #PED41331

AMEREX	PART
DUKES	#116
NOZZLES	#116
DUKES	#116
NOZZLES	#116
NOZZLES	#13729

NOTES:
1. ALL FUSIBLE LINKS ARE 500°
2. ALL BLOW-OFF CAPS ARE HIGH TEMP METAL PART #12504
3. PIPE DROPS, NOZZLES AND SWIVEL ELBOWS FURNISHED AND INSTALLED BY THE FIRE SYSTEM CONTRACTOR.

ANSUL PIPING PART NUMBERS	
DUCT NOZZLE	PART # (2W) 419337
PLENUM NOZZLE	PART # (1N) 419335
FUSIBLE LINK	PART #56816
DUKE NOZZLES	PART # (245) 419340
NIECO NOZZLES	PART # (245) 319340

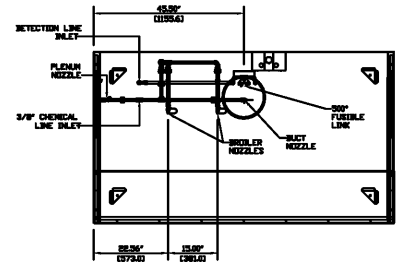

1 FIRE SUPPRESSION PIPING DETAIL
SCALE: NO SCALE

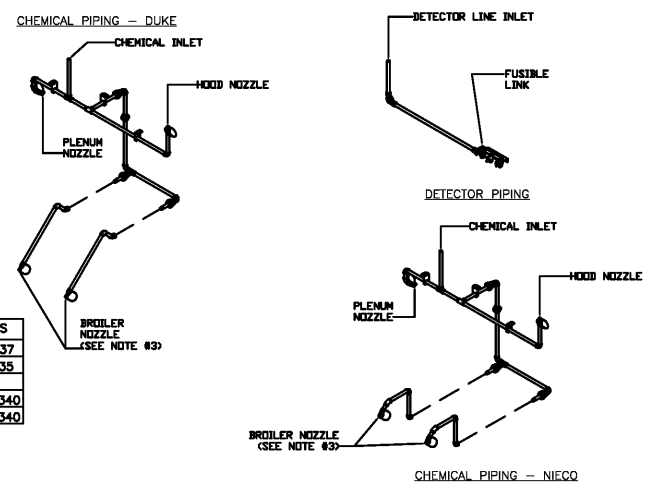

2 ANSUL/AMEREX FIRE SUPPRESSION ISOMETRIC DETAIL
SCALE: NO SCALE

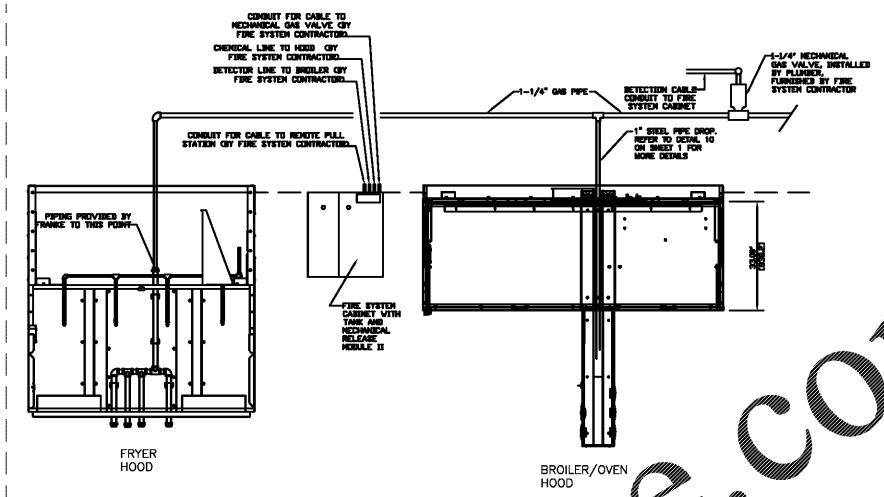

3 TYPICAL WALL MOUNTED FIRE SYSTEM USING ONE SYSTEM FOR TWO HOODS
SCALE: NO SCALE

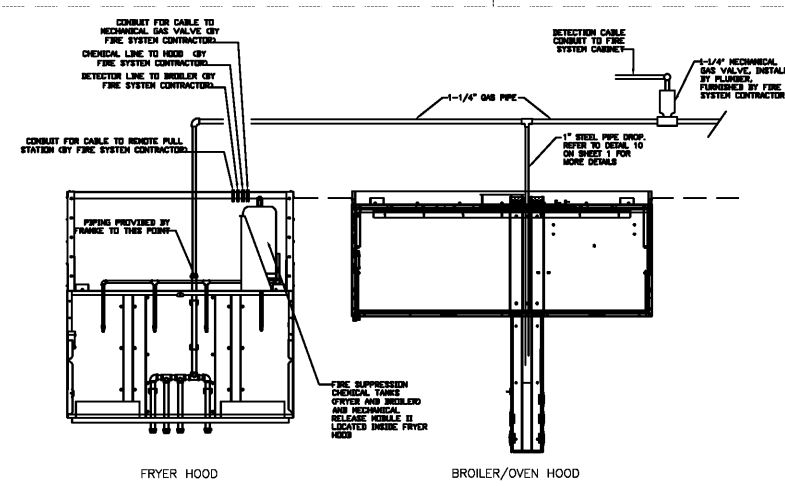

4 TYPICAL WALL MOUNTED FIRE SYSTEM USING ONE SYSTEM FOR TWO HOODS
SCALE: NO SCALE

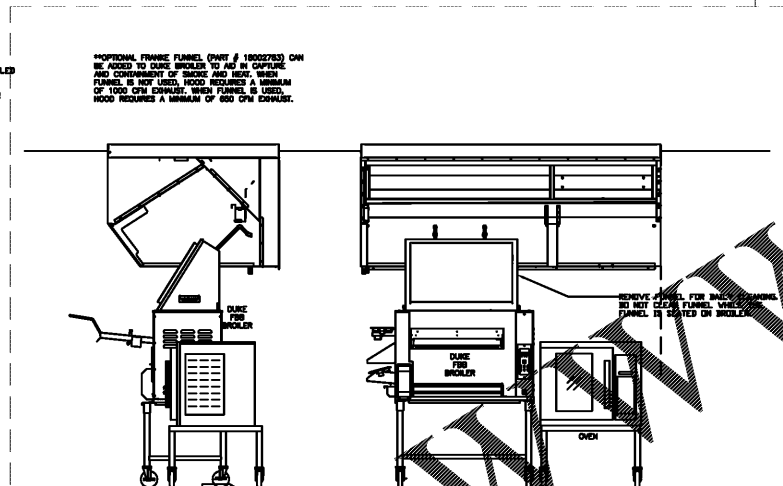

5 FRANKE FUNNEL DETAIL
SCALE: NO SCALE

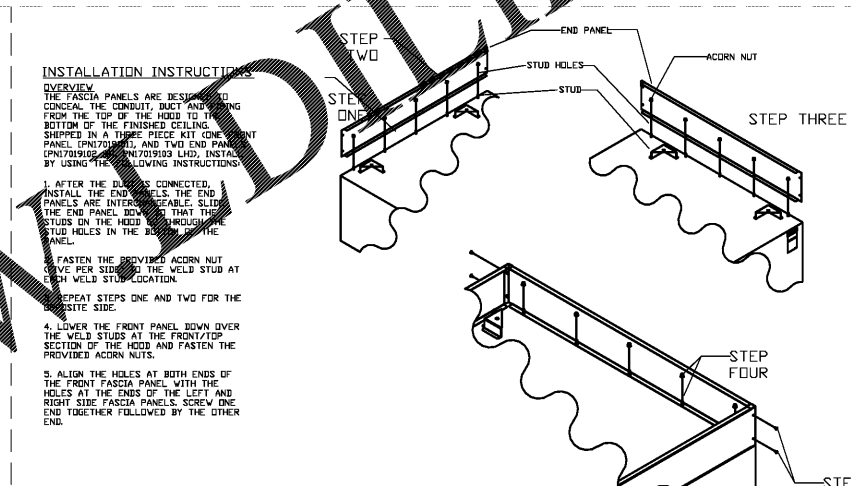

6 FASCIA PANEL INSTALLATION DETAIL
SCALE: NO SCALE

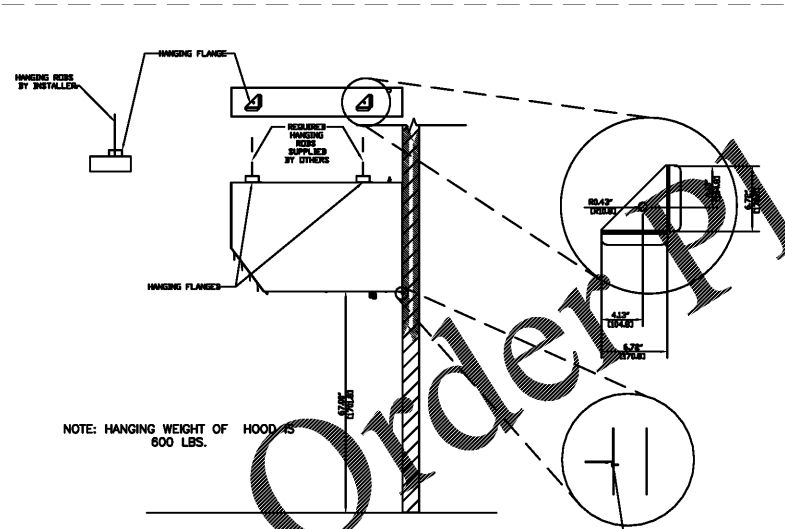

7 MOUNTING DETAIL
SCALE: NO SCALE

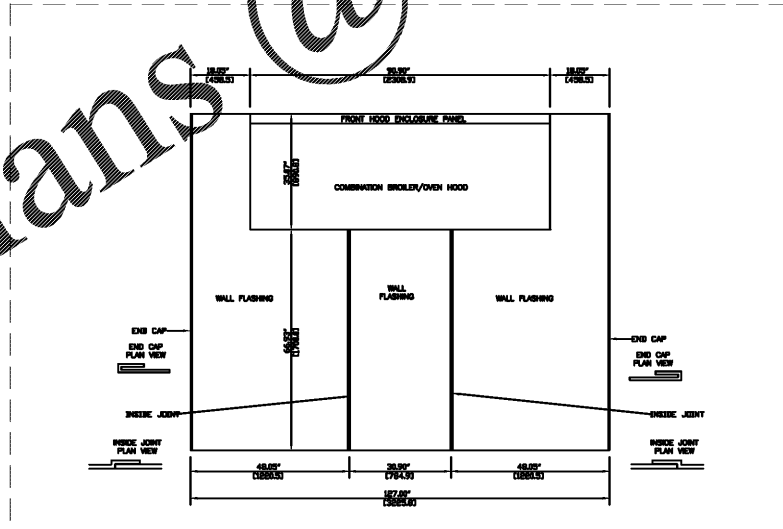

8 WALL FLASHING DETAIL
SCALE: NO SCALE

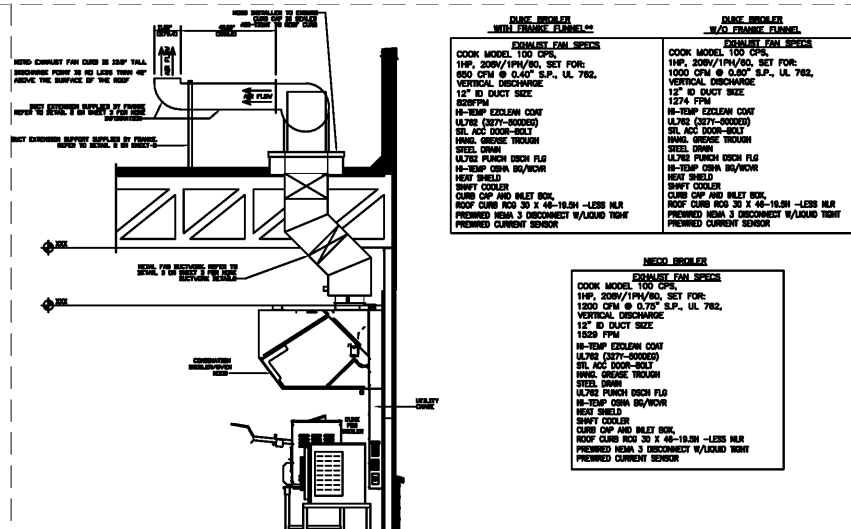

9 EXHAUST FAN DETAIL
SCALE: NO SCALE

HVAC SYSTEM
N-C-A
CONSULTANTS / GROUP
6510 N. 125TH AVENUE, SUITE #1001
LARGO, FLORIDA
PHONE: (877) 530-0078
CALL NCA MARKETING FOR PRICING
NCA JOB# 20963

PALMETTO BURGER KING
3765 ROOSEVELT HWY., PALMETTO, GA.
FOR: JP DESIGN & CONSTRUCTION
JACKSON, GA.

REVISIONS

SHEET TITLE
HOOD DETAILS

DATE
10-30-20

PROJECT NUMBER
20-197

SHEET NUMBER
M5

©Copyright 2020- Drawings, specifications, notes, database, computer files, field data, and reports as instruments of service prepared by the Design of Record. As instruments of services, these items remain the property of the Design of Record, who shall retain all statutory and other reserved rights, including the copyright thereto. Any use, reproduction or changes to these documents without written consent of NCA Consultants is a violation of federal copyright laws.