

1 LAY-IN AIR DEVICE INSTALLATION DETAIL
M-2.1 NOT TO SCALE

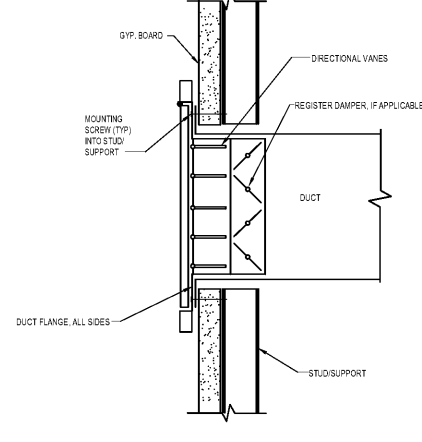

2 WALL MOUNTED AIR DEVICE DETAIL
M-2.1 NOT TO SCALE

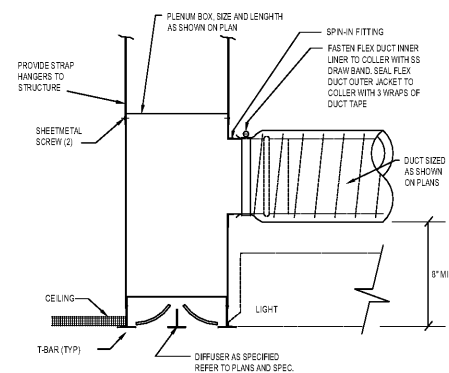

3 LINEAR SLOT DIFFUSER DETAIL
M-2.1 NOT TO SCALE

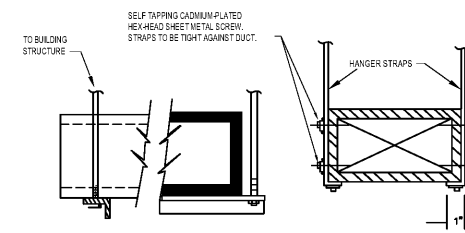

HANGER SIZES FOR RECTANGULAR DUCTS			
MAX. SIDE	HANGER	SUPPORT ANGLE HORIZONTAL	SPACING MAXIMUM
30"	1" x 1/8" GAUGE STRAP	NONE REQUIRED	19'-0"
36"	1/4" ROUND ROD	1-1/2" x 1-1/2" x 1/8"	8'-0"
48"	1/4" ROUND ROD	2" x 2" x 1/8"	8'-0"
60"	5/16" ROUND ROD	2" x 2" x 1/8"	8'-0"
84"	3/8" ROUND ROD	2" x 2" x 1/8"	8'-0"

4 RECTANGULAR DUCT HANGER DETAIL
M-2.1 NOT TO SCALE

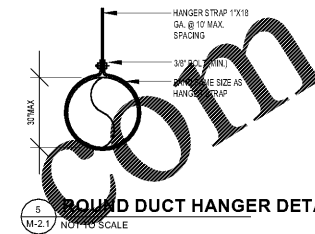

5 ROUND DUCT HANGER DETAIL
M-2.1 NOT TO SCALE

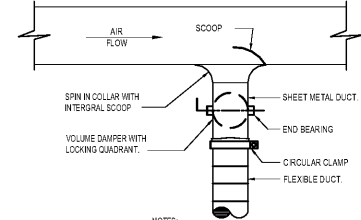

6 TYPICAL BRANCH TAKE-OFF DETAIL
M-2.1 NOT TO SCALE

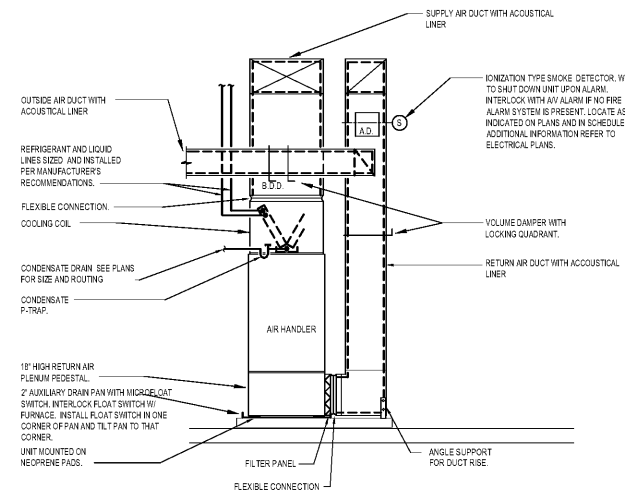

7 AIR HANDLER DETAIL
M-2.1 NOT TO SCALE

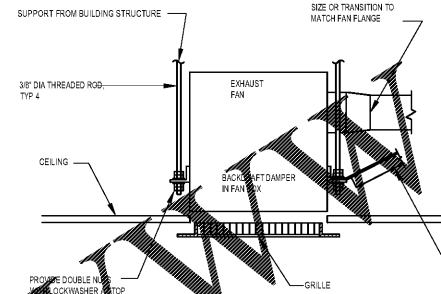

8 CEILING EXHAUST FAN
M-2.1 NOT TO SCALE

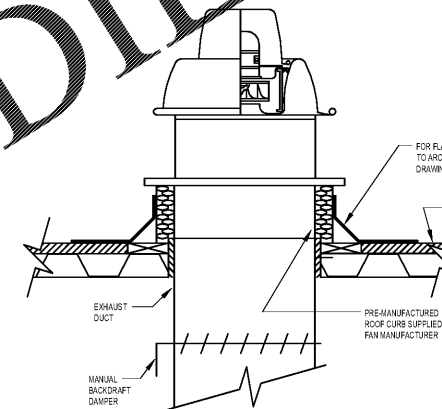

9 ROOF EXHAUST FAN DETAIL
M-2.1 NOT TO SCALE

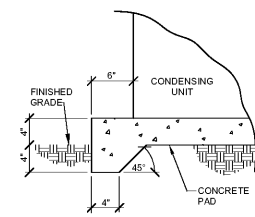

10 CONDENSING UNIT PAD DETAIL
M-2.1 NOT TO SCALE

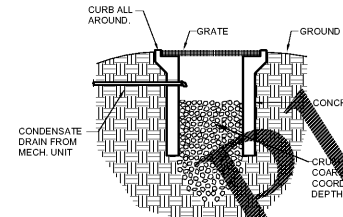

11 DRIVELWELL DETAIL
M-2.1 NOT TO SCALE

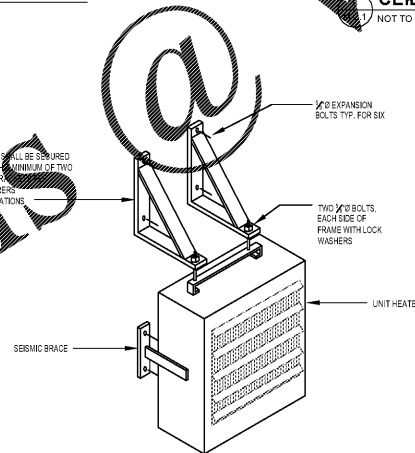

12 ELECTRIC UNIT HEATER MOUNTING DETAIL
M-2.1 NOT TO SCALE

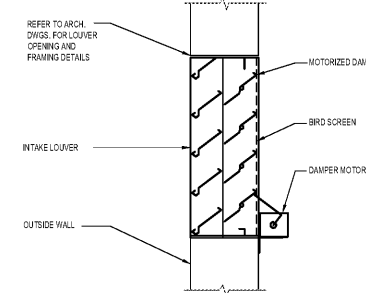

13 COMBINATION LOUVER DETAIL
M-2.1 NOT TO SCALE

Order Plans @



ROBERT JOHNSON
architects
1808 West Morehead St.
Charlotte, NC 28208
T 704 / 342.1058
F 704 / 342.3043

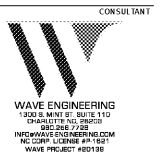

MIDSOUTH
CARPENTER'S
TRAINING
TRUST
La Vergne, TN

PROJECT NUMBER 1987
ISSUE DATE
FOR PERMIT 09.30.20

DRAWING DATA
DRAWN BY: MRM
CHECKED BY:

SHEET TITLE
MECHANICAL
DETAILS

This drawing is the property of ROBERT JOHNSON ARCHITECTS, INC. and is not to be reproduced or copied in whole or in part. It is only to be used for the project and site specifically identified therein and is not to be used on any other project. It is to be returned upon request.

SHEET NUMBER

M-2.1