

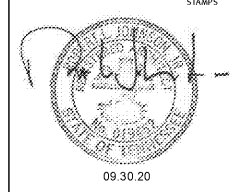

ROBERT JOHNSON
architects
1808 West Morehead St.
Charlotte, NC 28208
T 704 / 342.1058
F 704 / 342.3043



09.30.20

CONSULTANT

MIDSOUTH CARPENTER'S TRAINING TRUST
LA VERGNE, TN

PROJECT NUMBER 1982
ISSUE DATE
FOR PERMIT 09.30.20

DRAWING DATA
DRAWN BY: BM/LM
CHECKED BY: TH

SHEET TITLE
SECTION DETAILS

This drawing is the property of ROBERT JOHNSON ARCHITECTS, INC. and is not to be reproduced or copied in whole or in part. It is only to be used for the project and site specifically identified herein and is not to be used on any other project. It is to be returned upon request.

SHEET NUMBER

A-6.3

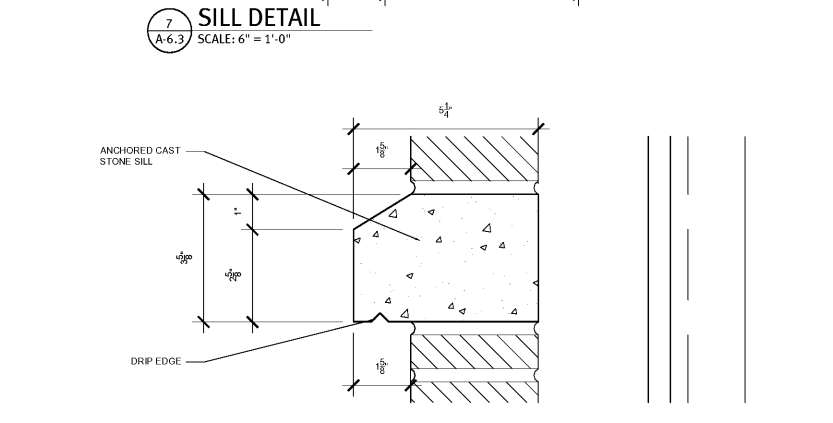
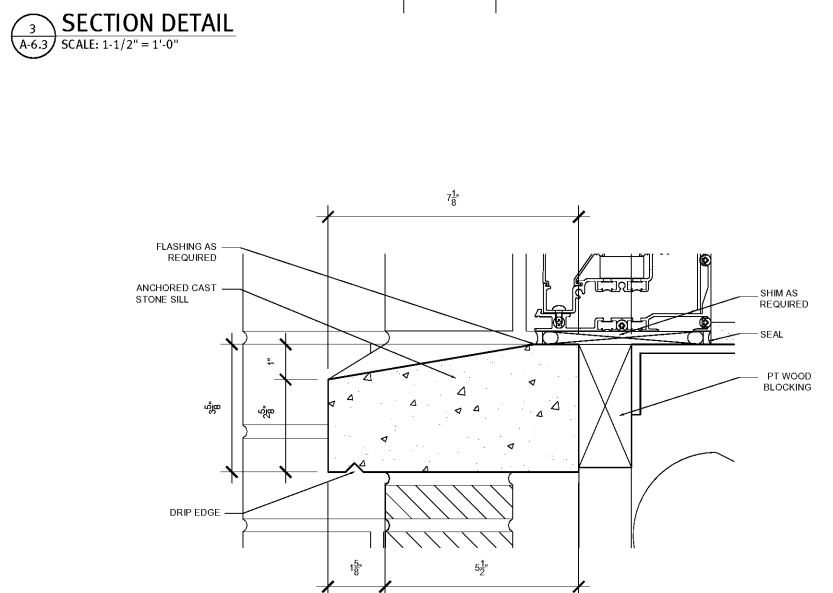
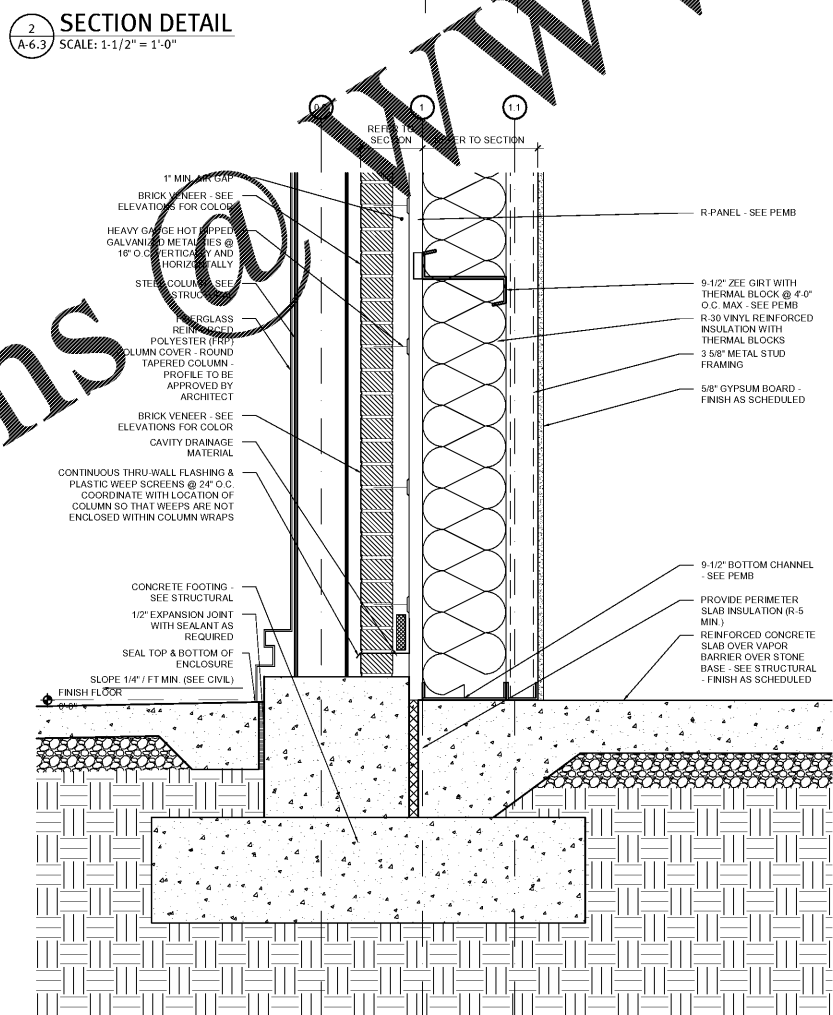
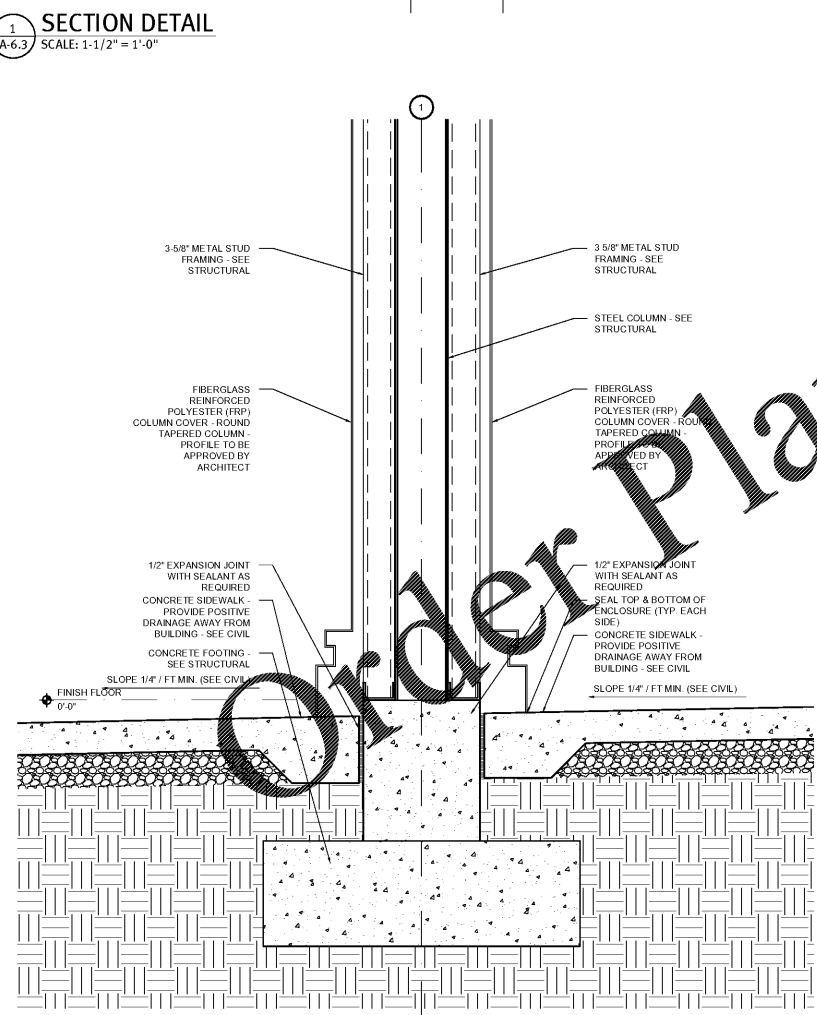
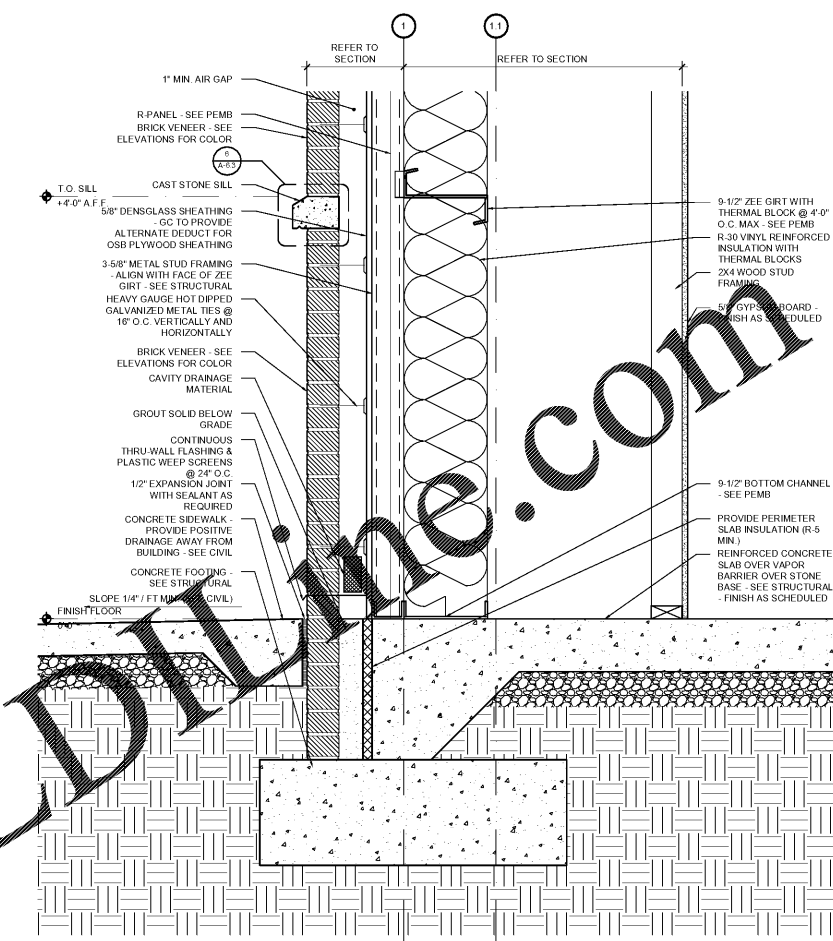
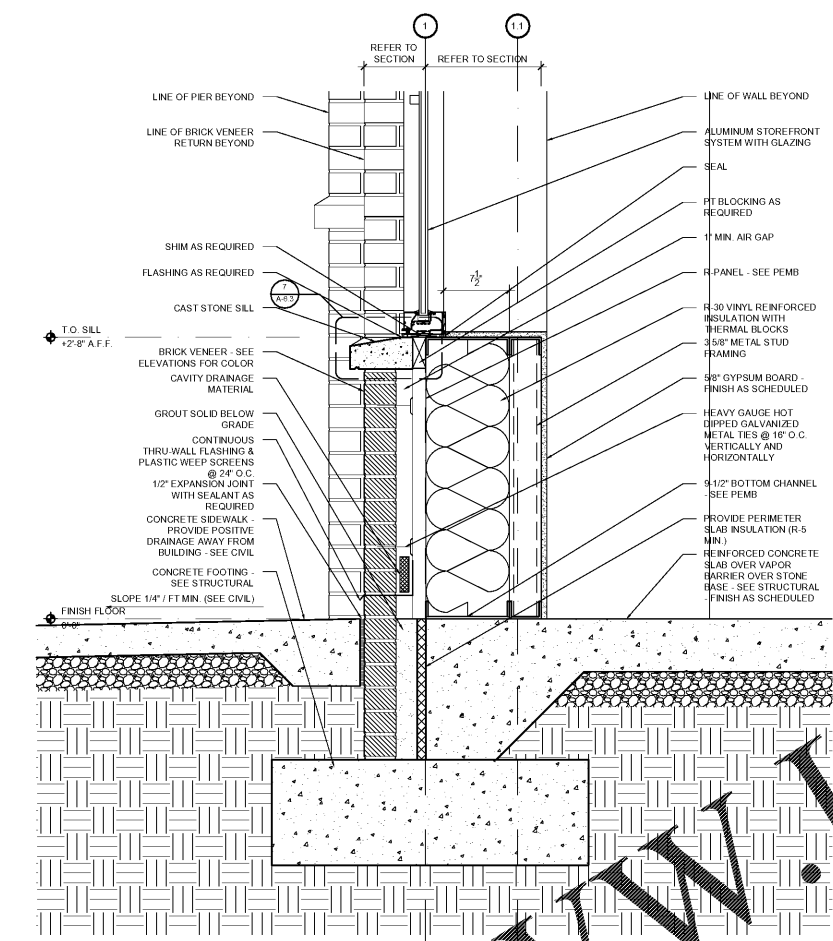
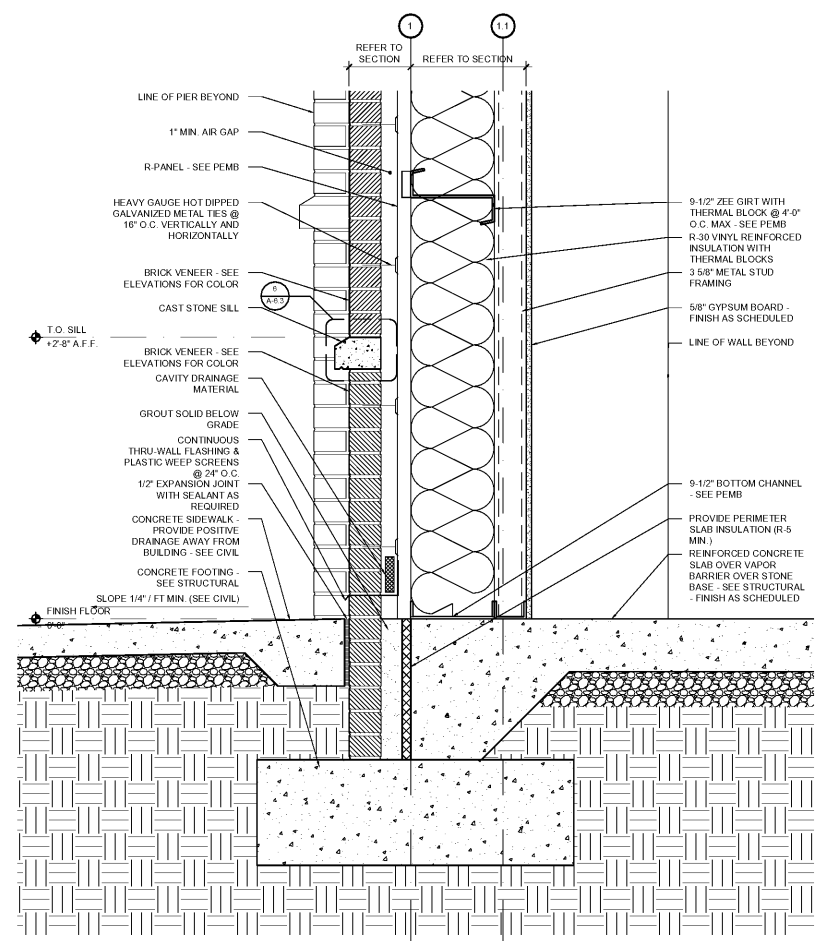

Order Plans

WWW.LDLINE.COM