

1 ADA FRONT CHECKOUT COUNTER  
A6 SCALE: 1/2" = 1'-0"

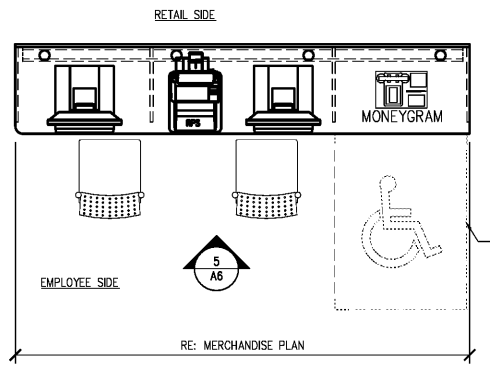

4 ADA PHOTOLAB COUNTER  
A6 SCALE: 1/2" = 1'-0"

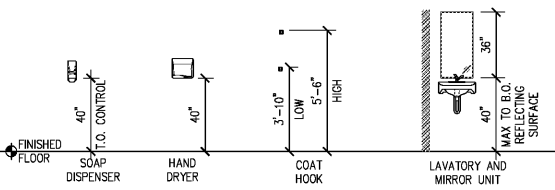

7 ACCESSIBLE MOUNTING HEIGHTS  
A6 SCALE: 1/4" = 1'-0"

GENERAL NOTES  
1. INSTALL INSULATION ON ALL EXPOSED WATER SUPPLY VALVES AND EXPOSED PIPES. ENSURE THAT ALL OTHER SHARP OR ABRASIVE SURFACES ARE PROPERLY COVERED OR FILED SMOOTH.  
2. SEE CURRENT SHEET FOR MOUNTING HEIGHTS OF NEW AND/OR RELOCATED TOILET ROOM ACCESSORIES. VERIFY HEIGHT WITH LOCAL CODES.  
3. 6"x9" ACCESSIBLE TOILET ROOM SIGNAGE TO BE WHITE TEXT AND SYMBOL IN BLUE BACKGROUND TYP. VERIFY REQUIREMENTS WITH LOCAL CODES.

NOTES:  
- ALL MOUNTING HEIGHT DIMENSIONS ARE TO TOP OR BOTTOM OF ACCESSORY, UNLESS OTHERWISE NOTED.  
- REFER TO PLANS/ELEVATIONS FOR SITE SPECIFIC INFORMATION ON FIXTURES AND ACCESSORIES.

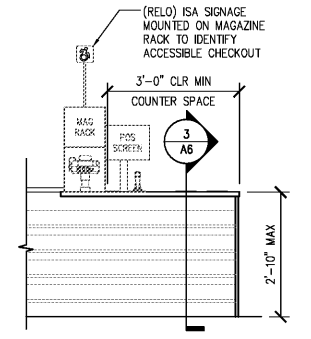

2 ADA FRONT CHECKOUT COUNTER ELEVATION  
A6 SCALE: 1/2" = 1'-0"

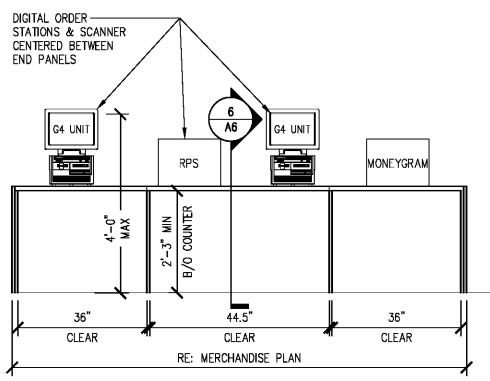

5 ADA PHOTOLAB COUNTER ELEVATION  
A6 SCALE: 1/2" = 1'-0"

ACCESSORY	WOMEN'S			MEN'S			MODEL NUMBER
	TO REMAIN	DEMOLISH	RELOCATE	TO REMAIN	DEMOLISH	RELOCATE	
TOILET PAPER HOLDER							BRADLEY 5126
TOILET SEAT COVER DISPENSER							TOUGH GUY 2VEX8
42" GRAB BAR							BRADLEY 8120-001420L
36" GRAB BAR							BRADLEY 8120-001360
18" GRAB BAR							BRADLEY 8120-001180
18" X 36" MIRROR							BRADLEY 781-1836
SOAP DISPENSER							GOJO 5W626
HAND DRYER							BRADLEY 2902-2800, 110/120V
WASTE RECEPTACLE							BOERICK B-279
FEMININE NAPKIN WASTE RECEPTACLE							GRAINGER 1E0K9
PAPER TOWEL							N/A
BABY CHANGING STATION							RUBBERMAID 7818-88
HOOKS							BRADLEY 9114
DOOR CLOSER							DORMA 8616 RFP SW (NO SUBSTITUTE)
RESTROOM SIGNAGE							NET'S ISA GRAPHIC
CANE TOUCH APRON							MANUFACTURER: HALSEY TAYLOR, MODEL: 18324

REFER TO X/XX & ELEVATIONS FOR FIXTURE MOUNTING HEIGHTS AND LOCAL CODES.

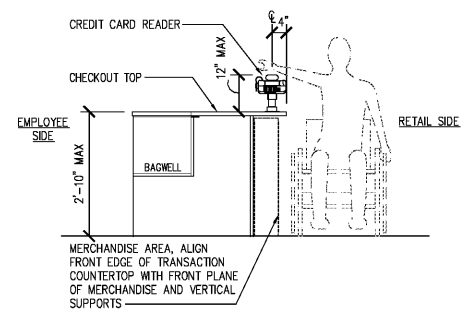

3 ADA FRONT CHECKOUT COUNTER SECTION  
A6 SCALE: 1/2" = 1'-0"

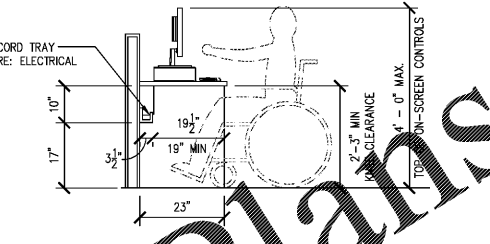

6 ADA PHOTOLAB COUNTER SECTION  
A6 SCALE: 1/2" = 1'-0"

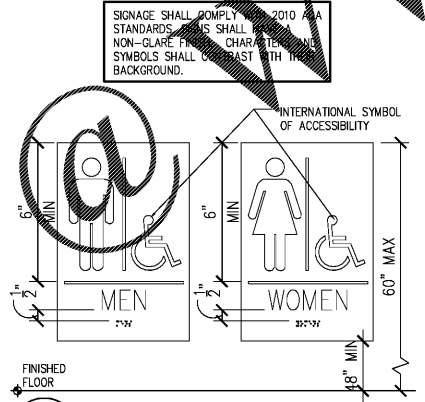

2 ACCESSIBLE RESTROOM SIGNAGE  
A3.2 SCALE: 3" = 1'-0"

Order Plans

WWW.LDILine.com



HEALTH HUB/Rx CONSULTATION  
STORE NUMBER: 4176

11 RIVER RIDGE DRIVE, OAKLEY PLAZA  
ASHEVILLE, NC 28803  
CAP CODE: 90

CS PROJECT NUMBER: 146740

ARCHITECT OF RECORD:

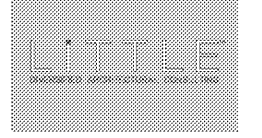

115 E. Main St., Ste 100, Asheville, NC 28801  
P: 704.258.3333 F: 704.258.3333

www.littleonline.com

The drawings and the design shown on the drawings of Little Architectural are the property of Little Architectural. Any reproduction, copying or alteration of this drawing without the prior written consent is prohibited and any reproduction will be subject to legal action.



DEVELOPER:



SEAL:



REVISIONS:

DRAWING BY: JC

CVS PROJECT MANAGER: RJ

DATE: 11-02-2020

JOB NUMBER: 121-14217-08

TITLE:

ACCESSIBLE DETAILS  
SHEET NUMBER:

A6

COMMENTS: