

STANDARD 90° VAN ACCESSIBLE PARKING SPACE STRIPING	STANDARD 90° VAN ACCESSIBLE PARKING SPACE STRIPING	STANDARD 90° VAN ACCESSIBLE PARKING SPACE STRIPING	STANDARD 90° VAN ACCESSIBLE PARKING SPACE STRIPING	STANDARD 90° VAN ACCESSIBLE PARKING SPACE STRIPING	STANDARD 90° VAN ACCESSIBLE PARKING SPACE STRIPING	STANDARD 90° VAN ACCESSIBLE PARKING SPACE STRIPING	STANDARD 90° VAN ACCESSIBLE PARKING SPACE STRIPING	STANDARD 90° VAN ACCESSIBLE PARKING SPACE STRIPING	STANDARD 90° VAN ACCESSIBLE PARKING SPACE STRIPING
1	2	3	4	5	6	7	8	9	10
11	12	13	14	15	16	17	18	19	20
21	22	23	24	25	26	27	28	29	30
31	32	33	34	35	36	37	38	39	40
41	42	43	44	45	46	47	48	49	50

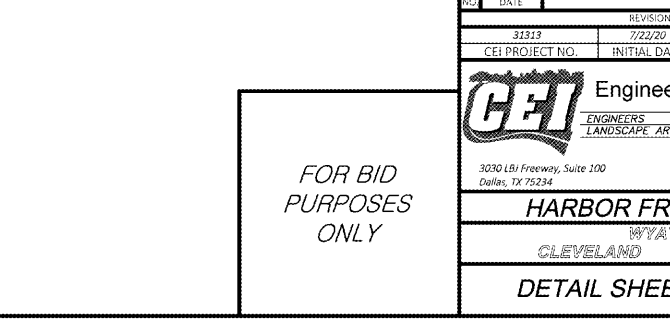
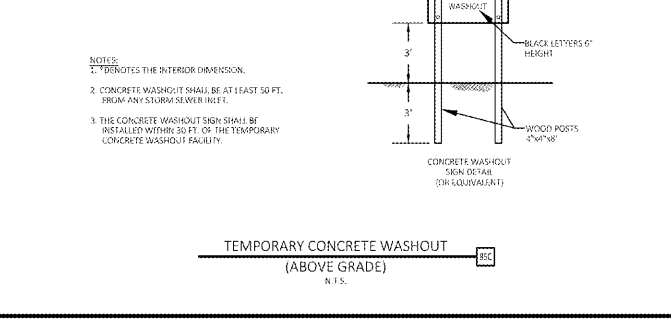
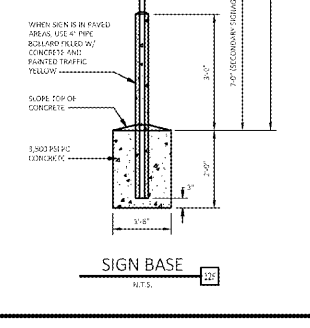
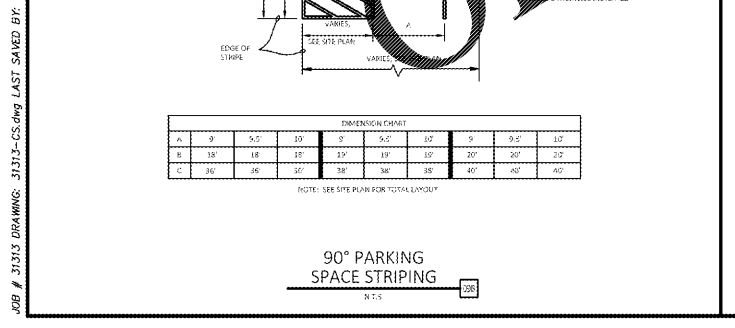
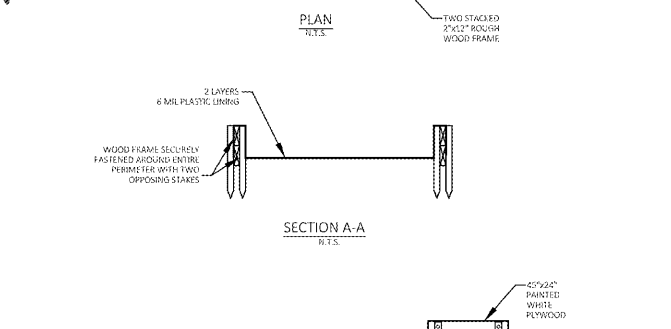
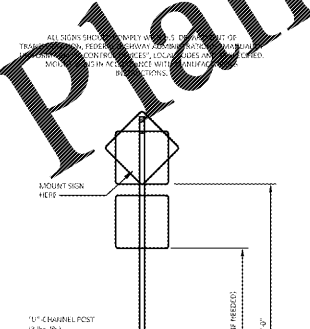
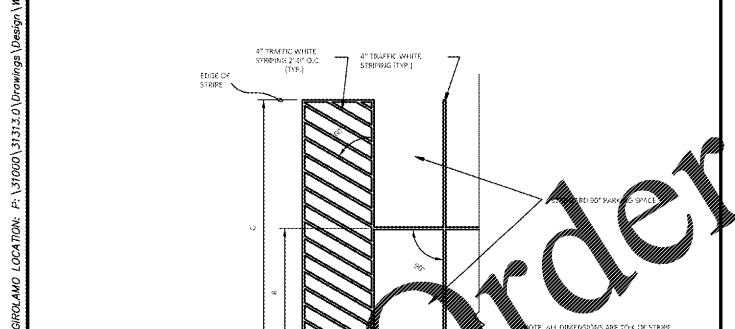
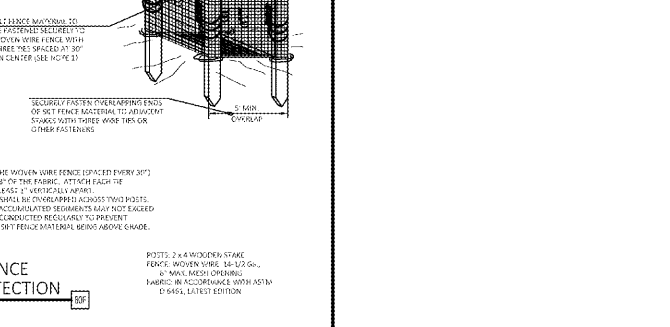
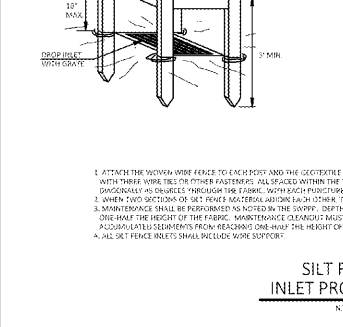
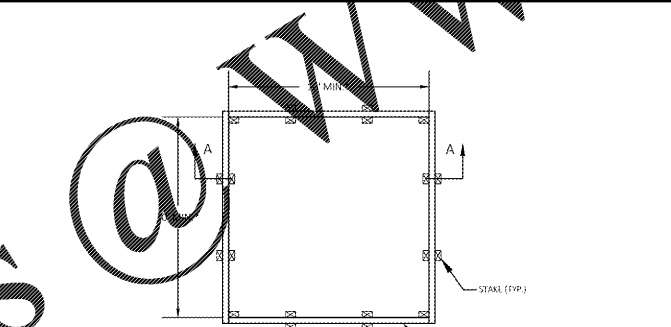
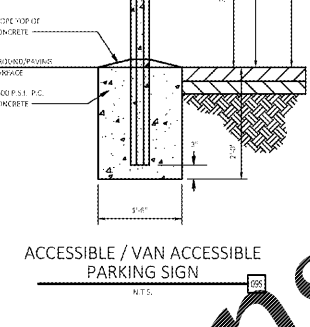
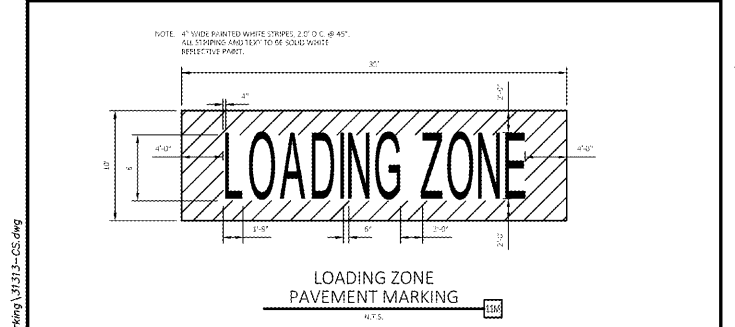
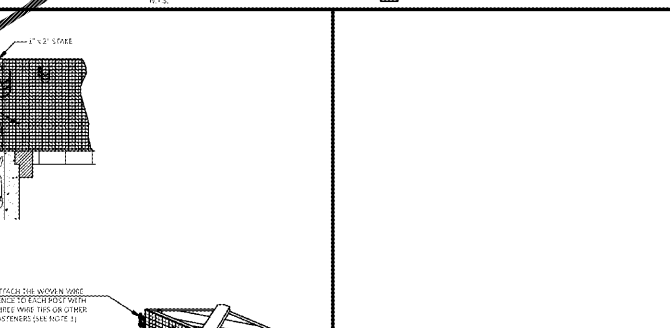
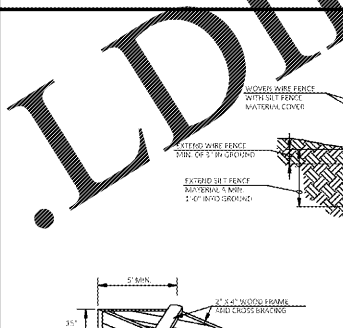
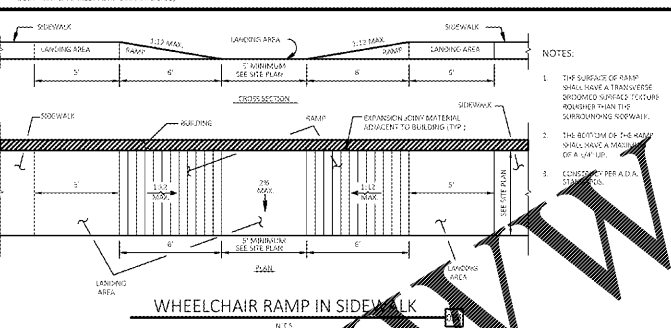
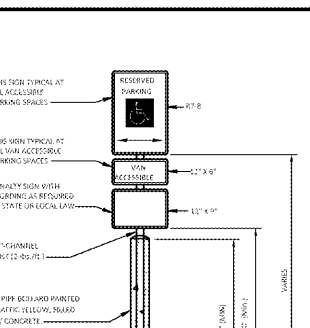
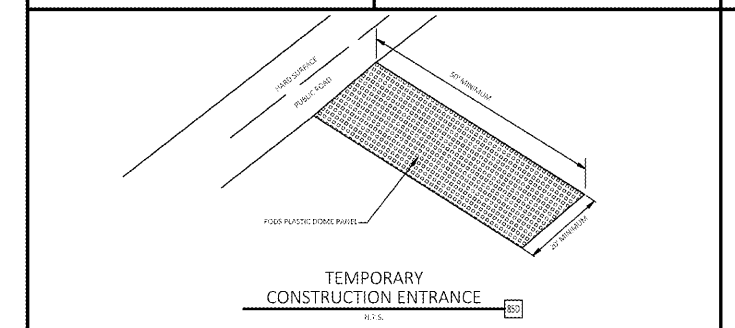
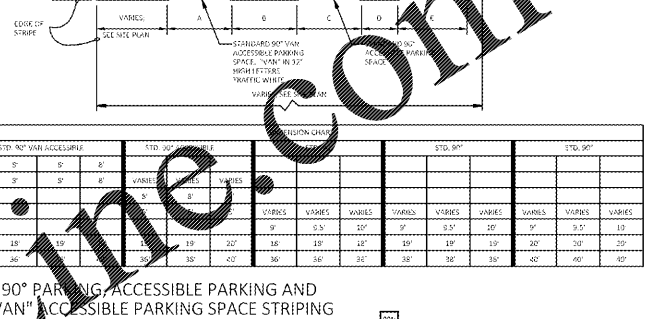
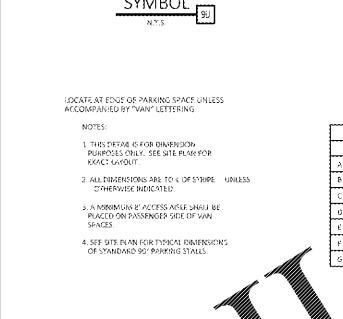
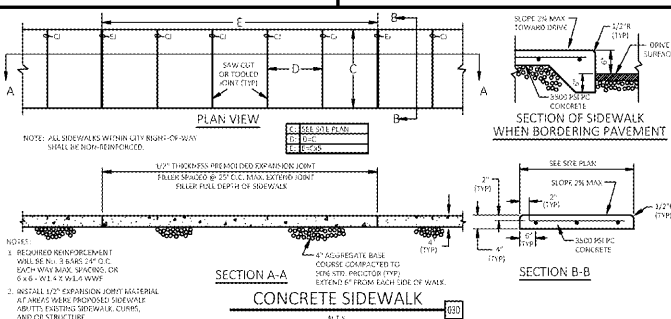
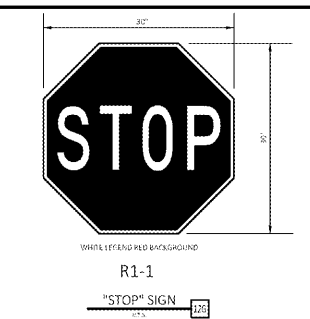
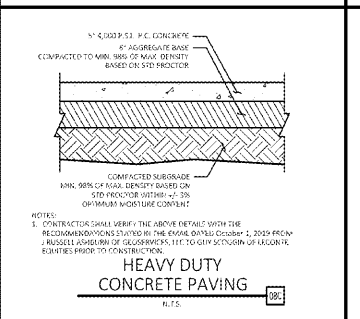
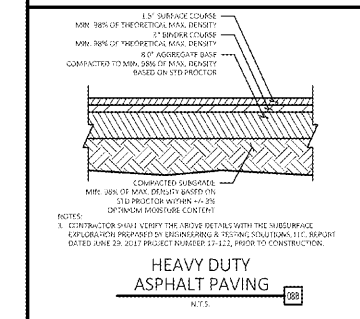

31313.DWG LAST SAVED BY: C:\GORDANO\LOCATIONS\F\_131000\31313.0 Drawings\Design\Working\31313-3-C9.dwg

31313.DWG LAST SAVED BY: C:\GORDANO\LOCATIONS\F\_131000\31313.0 Drawings\Design\Working\31313-3-C9.dwg

31313.DWG LAST SAVED BY: C:\GORDANO\LOCATIONS\F\_131000\31313.0 Drawings\Design\Working\31313-3-C9.dwg

31313.DWG LAST SAVED BY: C:\GORDANO\LOCATIONS\F\_131000\31313.0 Drawings\Design\Working\31313-3-C9.dwg

31313.DWG LAST SAVED BY: C:\GORDANO\LOCATIONS\F\_131000\31313.0 Drawings\Design\Working\31313-3-C9.dwg

NO.	DATE	REVISIONS	DESCRIPTION
1	7-22-2020	BULLETIN #2	
2	7/22/20	JDG	JEM
3	7/22/20	DPOR	PM
4	7/22/20	CAG	DES
5	7/22/20	CAG	DRW

**CEI Engineering Associates, Inc.**  
ENGINEERS • PLANNERS • SURVEYORS  
LANDSCAPE ARCHITECTS • ENVIRONMENTAL SCIENTISTS

3030 LBJ Freeway, Suite 100 Dallas, TX 75234 (972) 488-3737 FAX (972) 488-6732

**HARBOR FREIGHT TOOLS**  
WYATT RD. CLEVELAND TN

**DETAIL SHEET 1** REV. DATE 7/22/20 REV. - 1 SHEET NO. C9

FOR BID PURPOSES ONLY