

1 POWER DIAGRAM FOR EQ-O & DR N.T.S.

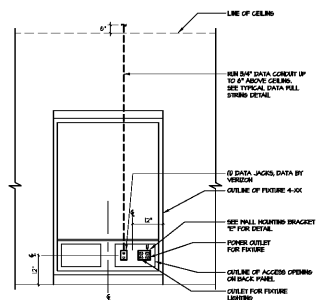

2 POWER DIAGRAM FOR 4-XX N.T.S.

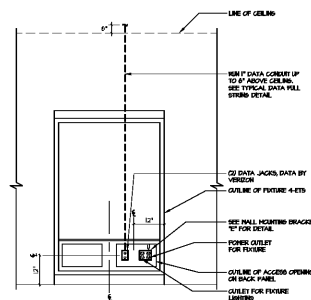

3 POWER DIAGRAM FOR 4-ETS N.T.S.

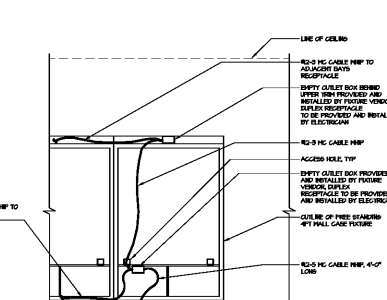

4 POWER DIAGRAM FOR FREE STANDING 4FT CABINETS N.T.S.

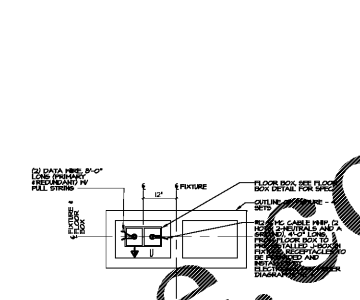

5 FLOOR BOX LOCATION DIAGRAM FOR FREESTANDING 4-ETS N.T.S.

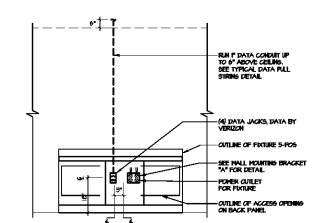

6 POWER DIAGRAM FOR 3-POS N.T.S.

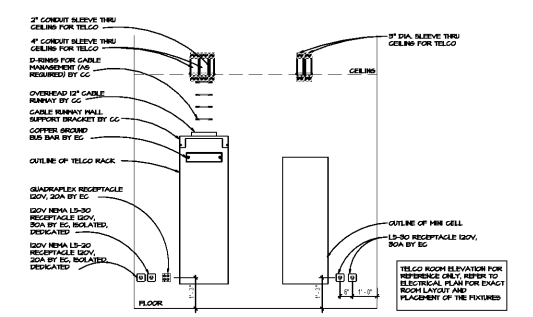

7 TYPICAL TELCO RACK AND MINI CELL (WHERE APPLICABLE) ELEVATION N.T.S.

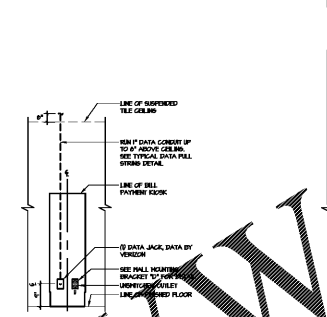

8 POWER DIAGRAM FOR BRAND WALL N.T.S.

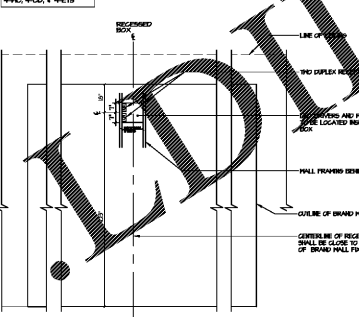

9 POWER DIAGRAM FOR BRAND WALL N.T.S.

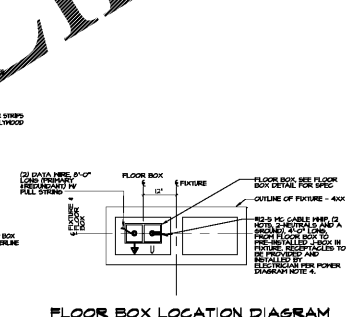

10 FLOOR BOX LOCATION DIAGRAM FOR FREESTANDING 4-XX FOR FIXTURES: 4-SK, 4-SS, 4-SK, 4-SS N.T.S.

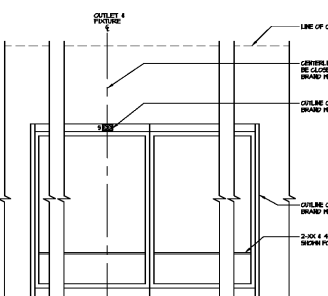

11 POWER DIAGRAM FOR FREE STANDING BRAND WALL N.T.S.

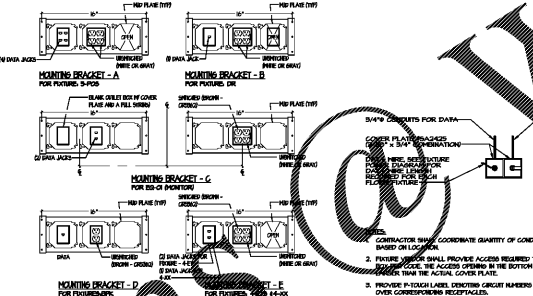

12 WALL MOUNTING BRACKET DETAILS N.T.S.

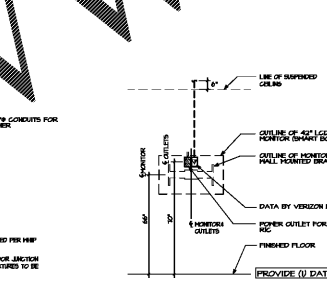

13 FLOOR BOX DETAIL N.T.S.

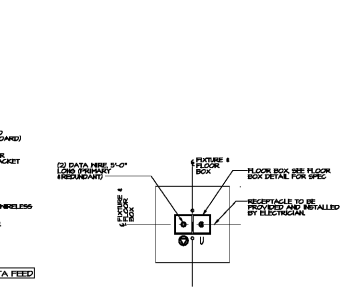

14 RIG MONITOR (RETAIL INFORMATION CENTER) N.T.S.

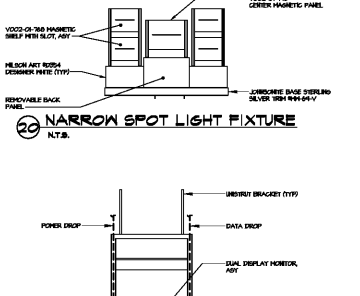

15 FLOOR BOX LOCATION DIAGRAM FOR KID'S TABLE N.T.S.

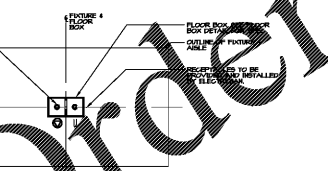

16 FLOOR BOX LOCATION DIAGRAM FOR AISLE BUSINESS TABLE N.T.S.

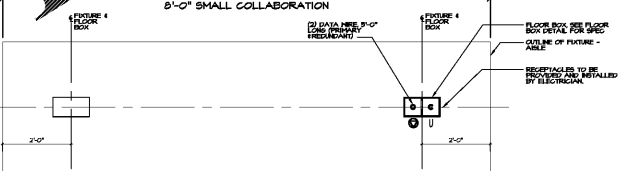

17 FLOOR BOX LOCATION DIAGRAM FOR COLLAB AND EXP. TABLES N.T.S.

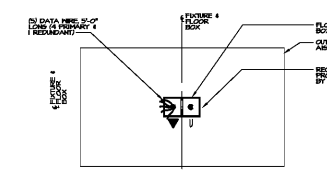

18 FLOOR BOX LOCATION DIAGRAM FOR 4-POS N.T.S.

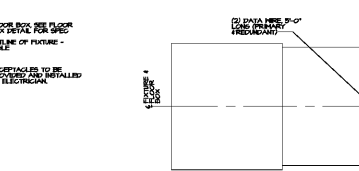

19 FLOOR BOX LOCATION DIAGRAM FOR SPOT N.T.S.



20 NARROW SPOT LIGHT FIXTURE N.T.S.

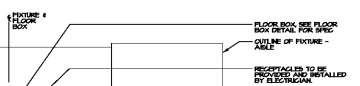

21 DIGITAL DISPLAY FIXTURE N.T.S.

Order Plans @ WWW.LDLINE.COM