

A SECTION AT EXTERIOR STUDWALL SIDEWALL
NOT TO SCALE

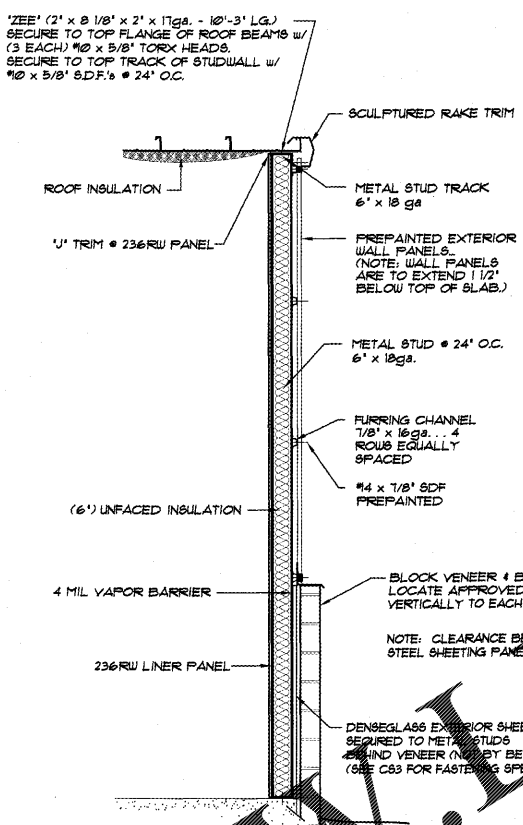

B SECTION AT EXTERIOR STUDWALL ENDWALL
NOT TO SCALE

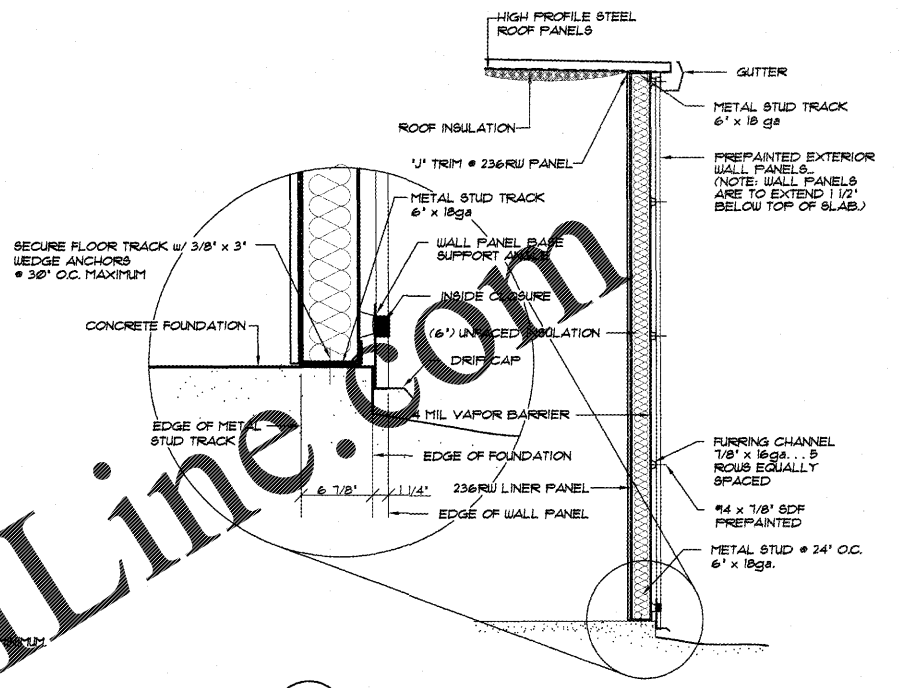

C SECTION AT EXTERIOR STUDWALL SIDEWALL
NOT TO SCALE

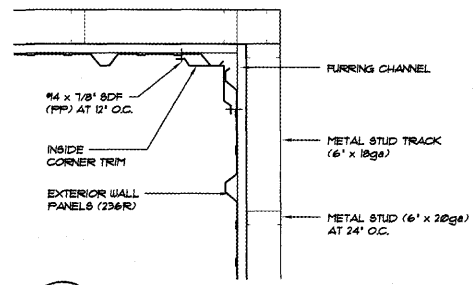

D SECTION AT EXTERIOR STUDWALL ENDWALL
NOT TO SCALE

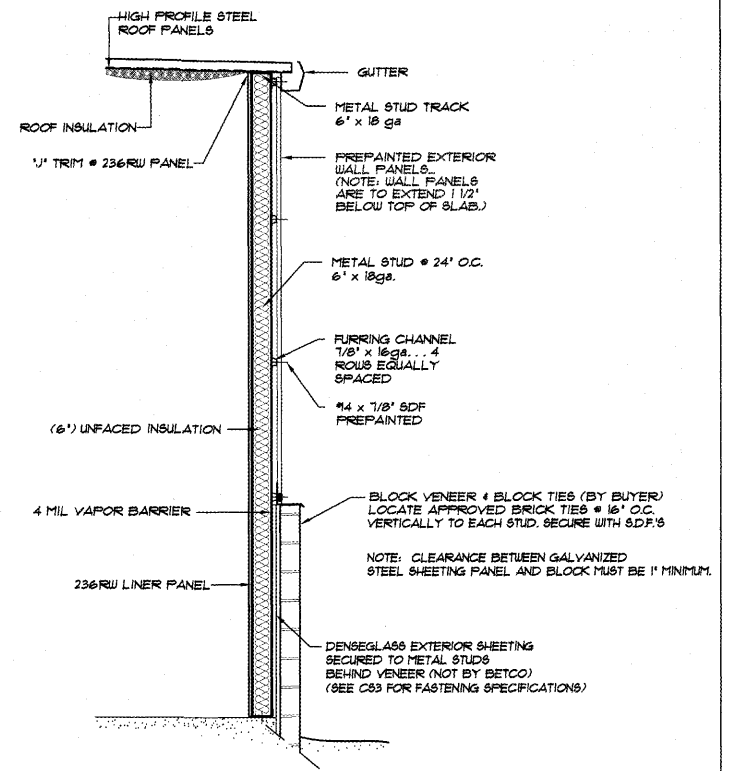

E SECTION AT EXTERIOR STUDWALL SIDEWALL
NOT TO SCALE



F INSIDE CORNER STUDWALL DETAIL
NOT TO SCALE

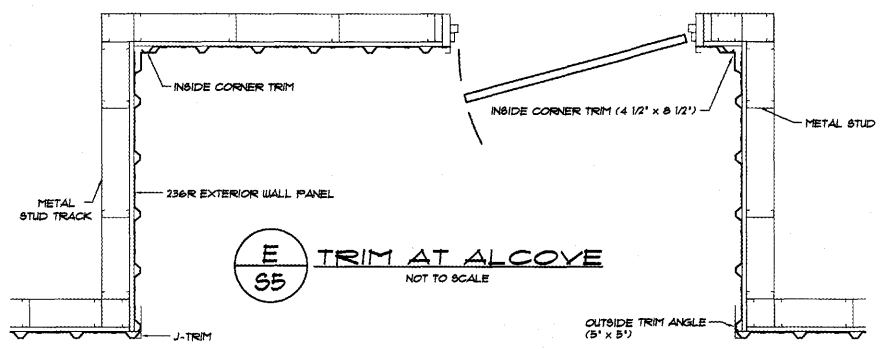

G TRIM AT ALCOVE
NOT TO SCALE

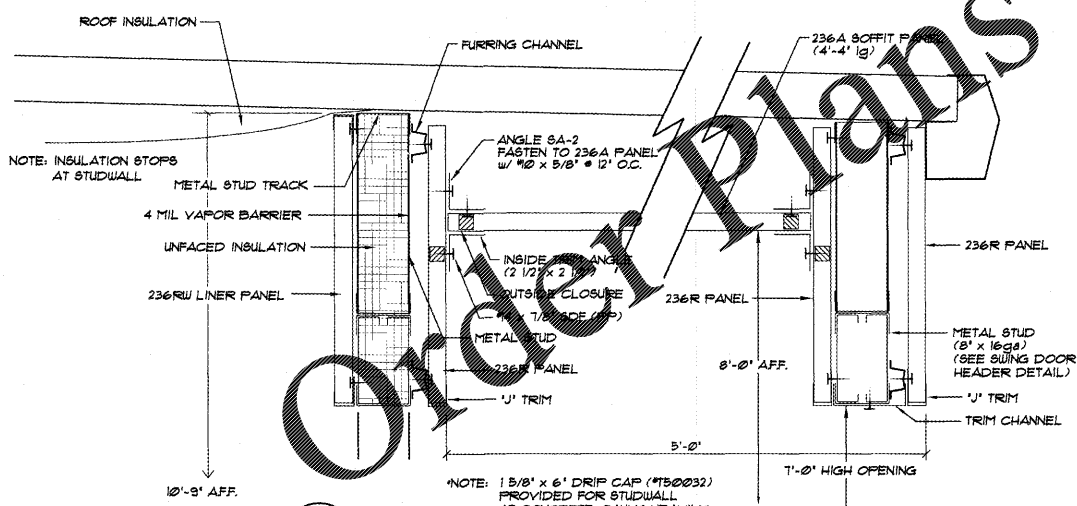

H TYPICAL ALCOVE SECTION
NOT TO SCALE

THIS ITEM HAS BEEN DIGITALLY SIGNED AND SEALED BY REED SELF ON THE DATE ADJACENT TO THE SEAL. PRINTED COPIES ARE NOT CONSIDERED SIGNED AND SEALED AND THE SIGNATURE MUST BE VERIFIED ON ANY ELECTRONIC COPIES

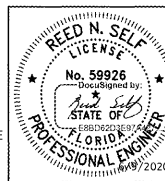

DATE:	2/11/20
DRAWN BY:	J. MORRISON
SCALE:	AS NOTED
APPROVED BY:	
REVISIONS:	
REVISED VAPOR BARRIER LOCATION	6/3/20 JCM
REVISED DETAILS	3/3/20 JCM

BETCO
228 COMMERCE BLVD.
STATESVILLE, NC 28625
(800) 654-7813

PROJECT NAME:	PUBLIC STORAGE - PS#28901
PROJECT ADDRESS:	APOPKA, FLORIDA
OWNER:	JANUS INTERNATIONAL
PROJECT NO.:	FL20016
SHEET TITLE:	BUILDING DETAILS BUILDING "1"
DRAWING NUMBER:	S5 of 9