

**TABLE MU-1 MULCHING MATERIALS AND APPLICATION RATES**

MATERIAL	RATE PER ACRE (PER 1,000 SQ. FT.)	NOTES
STRAW WITH SEED	1 1/2 - 2 TONS (70 LBS - 90 LBS)	SPREAD BY HAND OR MACHINE TO ATTAIN UNIFORM COVER. ANCHOR WHEN SUBJECT TO BLOWING.
STRAW ALONE (NO SEED)	2 1/2 - 3 TONS (115 LBS - 180 LBS)	SPREAD BY HAND OR MACHINE. SUBJECT TO BLOWING.
WOOD CHIPS	5-6 TONS (225 LBS - 270 LBS)	TREAT WITH 12 LBS NITROGEN.
BARK	30 CUBIC YARDS (9.8 CUBIC YARD)	CANARY WITH MULCH LOWER.
PINE STRAW	1-2 TONS (45 LBS - 90 LBS)	SPREAD BY HAND OR MACHINE. WILL NOT BLOW.
PEANUT HULLS	10-20 TON (450 LBS - 900 LBS)	WILL NOT BLOW. WILL NOT BLOW.

**TABLE TS-1 COMMONLY USED PLANTS FOR TEMPORARY COVER**

SPECIES	SEEDING RATE PER AC PLS	NORTH	CENTRAL	SOUTH
MILLET, BROWNTOP, OR GERMAN	40 LBS	MAY 1 - AUG 15	APR 1 - AUG 15	APR 1 - AUG 15
RYE	3 BU	SEPT 1 - NOV 15	SEPT 1 - NOV 15	SEPT 1 - NOV 15
RYEGRASS	30 LBS	AUG 1 - SEPT 15	SEPT 1 - OCT 15	SEPT 1 - OCT 15
SORGHUM - SUDAN HYBRIDS	40 LBS	MAY 1 - AUG 15	APR 1 - AUG 15	APR 1 - AUG 15
SUNDANGRASS	40 LBS	MAY 1 - AUG 15	APR 1 - AUG 15	APR 1 - AUG 15
WHEAT	3 BU	SEPT 1 - NOV 15	SEPT 1 - NOV 15	SEPT 1 - NOV 15
COMMON BERMUDAGRASS	10 LBS	APR 1 - JUL 15	MAR 1 - JUL 15	JULY 1 - JULY 15
CRIMSON CLOVER	10 LBS	SEPT 1 - NOV 15	SEPT 1 - NOV 15	SEPT 1 - NOV 15

**TABLE PS-1 COMMONLY USED PLANTS FOR PERMANENT COVER WITH SEEDING RATES AND DATES**

SPECIES	SEEDING RATE PER AC PLS	NORTH	CENTRAL	SOUTH
BAHAGRASS, PENSACOLA	40 LBS	MAR 1 - JULY 1	MAR 1 - JULY 1	FEB 1 - NOV 1
BERMUDAGRASS, COMMON	10 LBS	APR 1 - JUN 15	MAR 15 - JULY 15	MAR 1 - JULY 15
BAHAGRASS, PENSACOLA	30 LBS	MAR 1 - JULY 1	MAR 1 - JULY 1	MAR 1 - JULY 1
BERMUDAGRASS, COMMON	5 LBS	MAR 1 - JULY 1	MAR 1 - JULY 1	MAR 1 - JULY 1
BERMUDAGRASS, COMMON	SOLID SOD	ANYTIME	ANYTIME	ANYTIME
BERMUDAGRASS, HYBRID (LAWN TYPES)	150 FT	MAR 1 - AUG 1	MAR 1 - AUG 1	FEB 1 - SEPT 1
BERMUDAGRASS, SPRIGS	40 - 50 LBS	SEPT 1 - NOV 1	SEPT 1 - NOV 1	SEPT 1 - NOV 1
FESCUE, TALL	40 - 50 LBS	SEPT 1 - NOV 1	SEPT 1 - NOV 1	SEPT 1 - NOV 1
SERICEA	40 - 60 LBS	MAR 1 - JULY 15	MAR 1 - JULY 15	FEB 15 - JULY 15
SERICEA & COMMON BERMUDAGRASS	40 - 60 LBS	MAR 1 - JULY 15	MAR 1 - JULY 15	FEB 15 - JULY 15
SWITCHGRASS, ALAMO	4 LBS	APR 1 - JULY 15	MAR 15 - JULY 15	MAR 15 - JULY 15

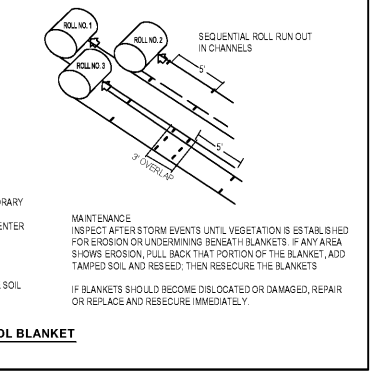
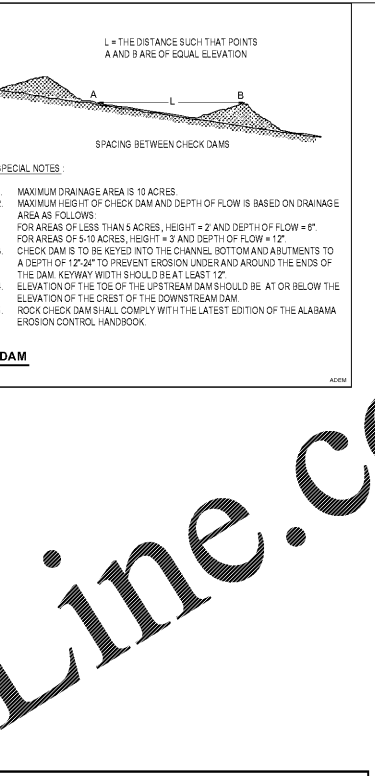
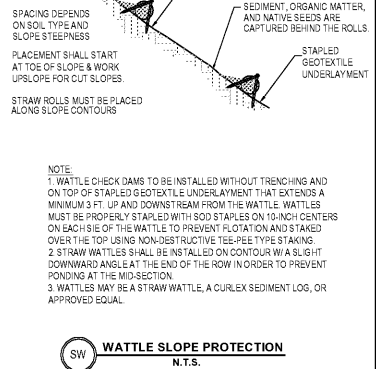
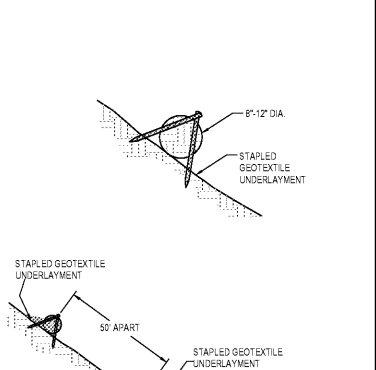
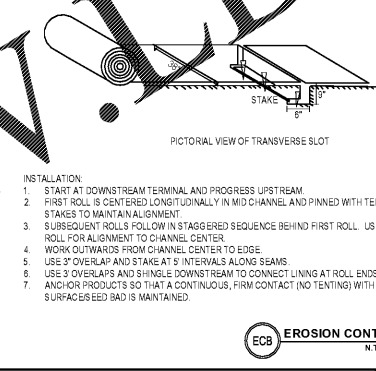
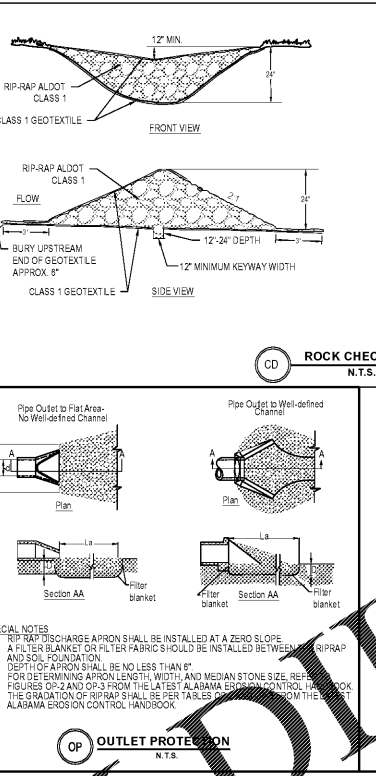
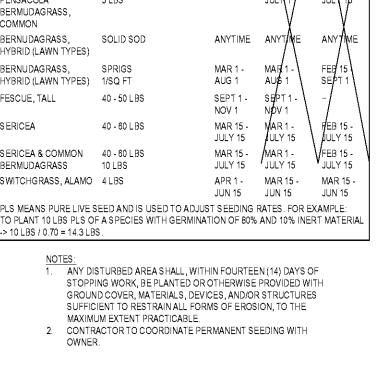
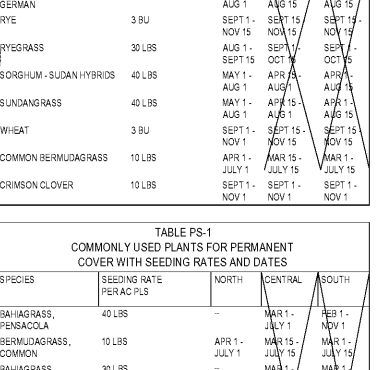
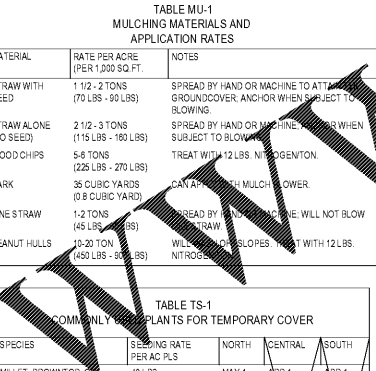
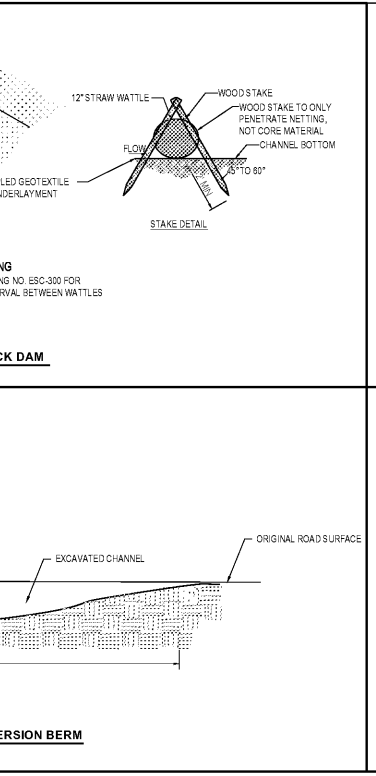
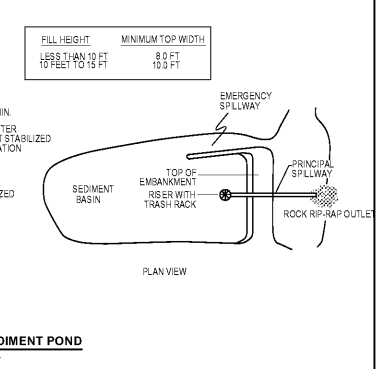

**LBVD, Inc.**  
Civil and Structural Engineers  
8802 Montgomery Road  
Suite 500  
Birmingham, AL 35223  
(205) 253-4900  
PROJECT NO. 102-20-003.001

**LATHAN ASSOCIATES ARCHITECTS, P.C.**  
300 CHASE PARK BLDG 111  
SUITE 200 - HOOPER, ALABAMA 35244  
PH: 205-988-1112 FAX: 205-988-9188

**NEW LIBRARY FOR THE CITY OF OPELIKA**  
GLENN STREET  
OPELIKA, ALABAMA 36801

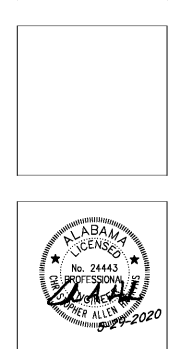

SHEET TITLE:  
EROSION CONTROL DETAILS

PROJ. MGR.: CAH  
DRAWN: TGB  
DATE: JUNE 1, 2020  
CHECKED BY: RAN  
REVISIONS:

JOB NO. 19-32  
SHEET NO. C8.2  
11 OF 11  
SEQUENCE NO. 12/90