

VICTOR STANLEY, INC. IRONBITE SERIES, MODEL: 8-42, 32 GALLON LITTER RECEPTACLE, STANDARD FORMED LID, MOUNT W/ (3) IN-LINE ANCHOR HOLES & STANDARD TAPERED LID, COLOR: BLACK

(800) 368-2573

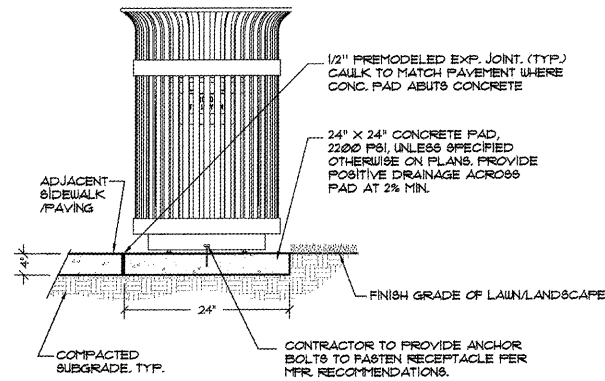

1 TRASH RECEPTACLE
NOT TO SCALE

VICTOR STANLEY, INC. CLASSIC SERIES BENCH, MODEL: CR-5, 6' SCROLLED STEEL SLATS, COLOR: POWDER-COATED BLACK (OR APPROVED EQUAL)

VICTOR STANLEY, INC. *Manufacturers of Quality Site Furnishings since 1902*
(800) 368-2573

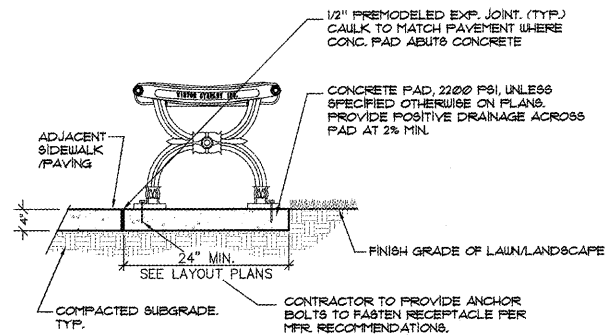

2 BENCHES
SCALE: NTS

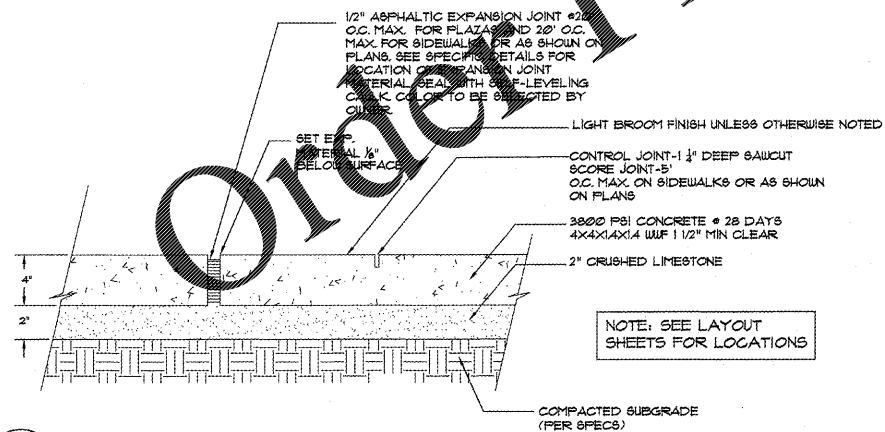

3 CONCRETE PAVING
NOT TO SCALE

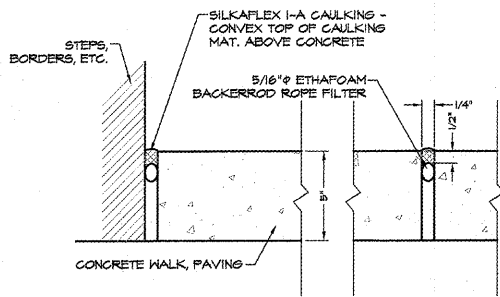

TYPICAL SECTION

4 EXPANSION/ISOLATION JOINT
NOT TO SCALE

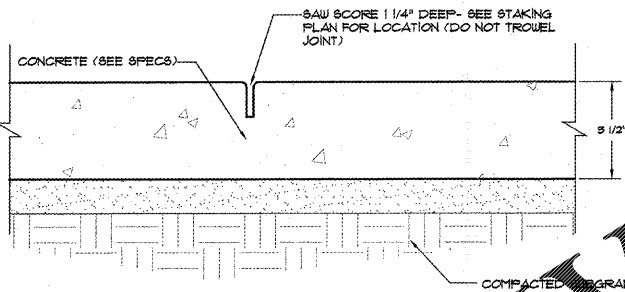

5 CONCRETE SAWCUT JOINTS
NOT TO SCALE

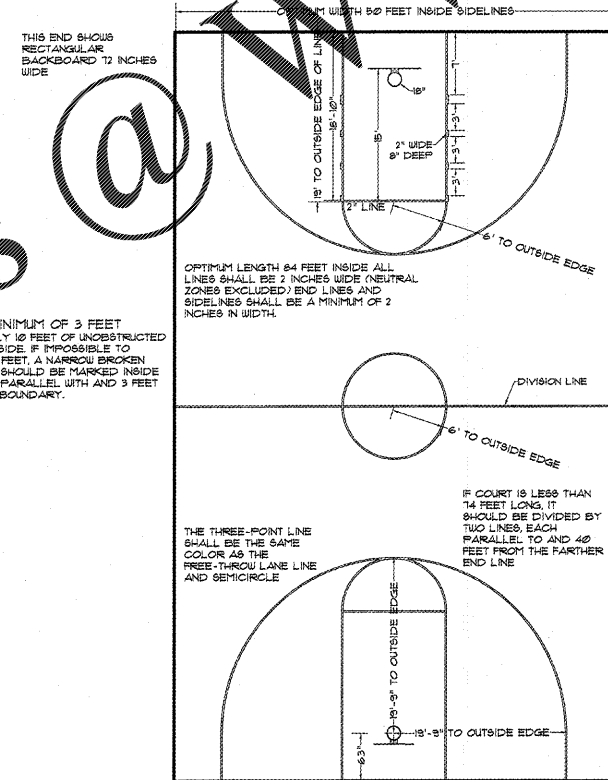

6 ASPHALT BASKETBALL COURT
NOT TO SCALE

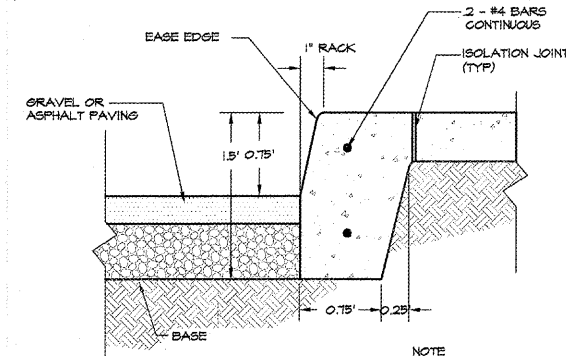

NOTE
CONCRETE FINISHES
WALK - LIGHT BROOM
CURB FACE - RUBBLE

7 INTEGRAL CURB AT WALK
NOT TO SCALE

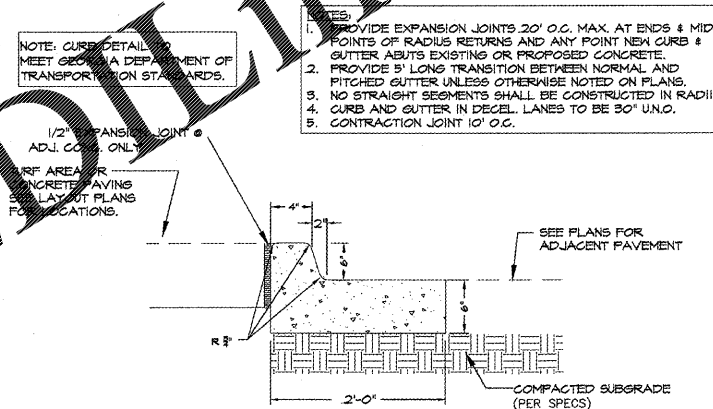

8 CONC. CURB & GUTTER
NOT TO SCALE

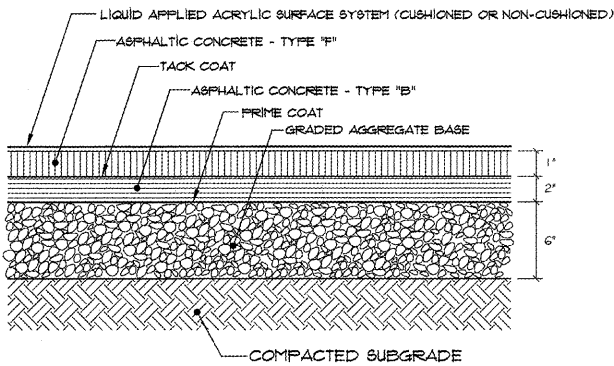

9 HEAVY DUTY ASPHALT BASKETBALL COURT
NOT TO SCALE

4317 Park Drive, Suite 100
Norcross, Georgia 30093
Phone: (770) 416-2711
Fax: (770) 416-0789
www.travispruit.com
CONTACT PERSON: TED ANDERSON
E-mail: tanderson@travispruit.com



CONSTRUCTION DETAILS

FREEDOM PARK PHASE 3

3301 ROFF AVENUE, MACON, GA 31204 • LAND LOTS 2 AND 3 • 11TH DISTRICT • CITY OF MACON • BIBB COUNTY GEORGIA



For The Firm
Travis Pruitt & Associates, Inc.

DATE: 02/14/2020
SCALE: N/A
CN: 190452PN
JN: 190452
FN: 166-D-038
SHEET NO: C6.0