

1 VENT THRU ROOF ("VTR") NOT TO SCALE

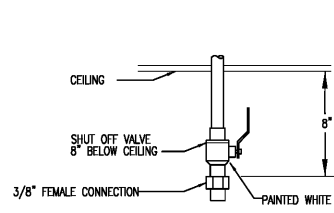

2 AIR DROP AT CEILING NOT TO SCALE

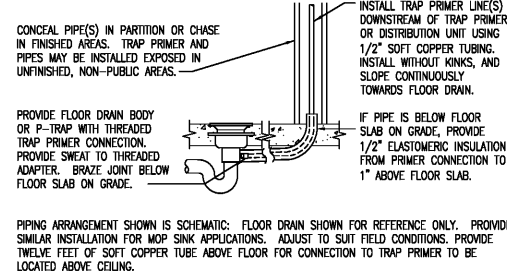

3 TRAP PRIMER INSTALLATION NO SCALE

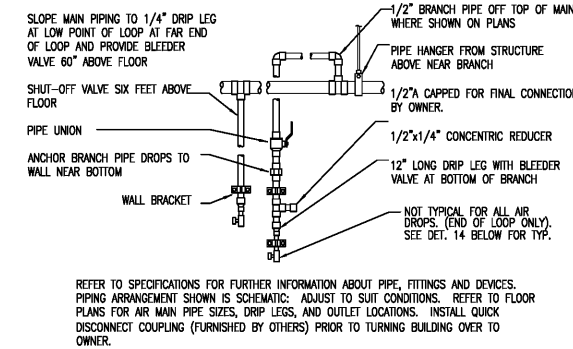

4 COMPRESSED AIR OUTLET NOT TO SCALE

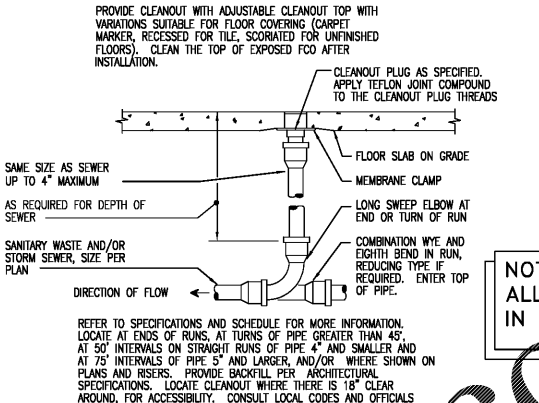

5 FLOOR CLEANOUT NOT TO SCALE

NOTE: ALL CLEANOUTS TO BE LOCATED IN CENTER OF BAY

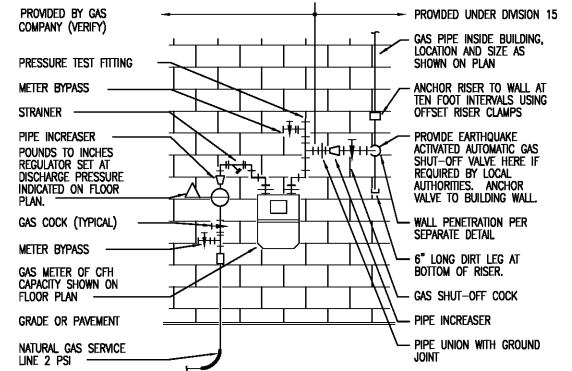

7 GAS METER SETTING NOT TO SCALE

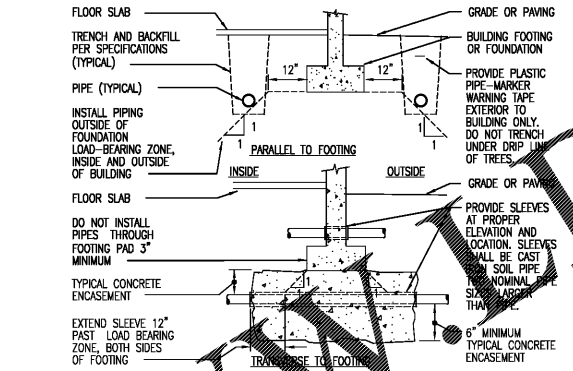

8 PIPE AND TRENCH LOCATION NOT TO SCALE

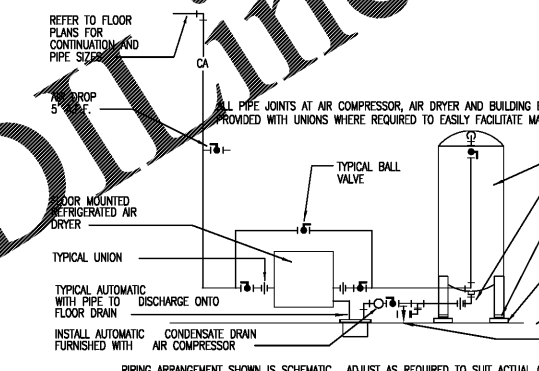

9 AIR COMPRESSOR PIPING SCHEMATIC NOT TO SCALE

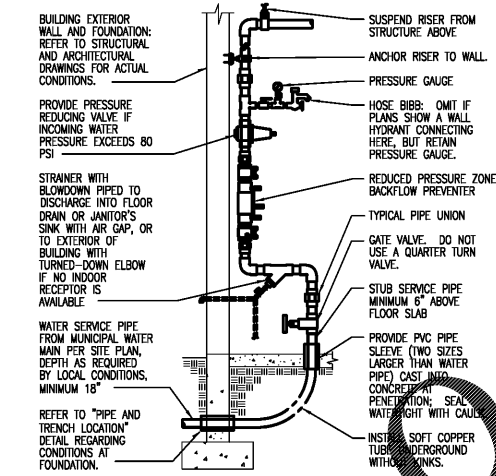

10 DOMESTIC WATER SERVICE ENTRY NOT TO SCALE

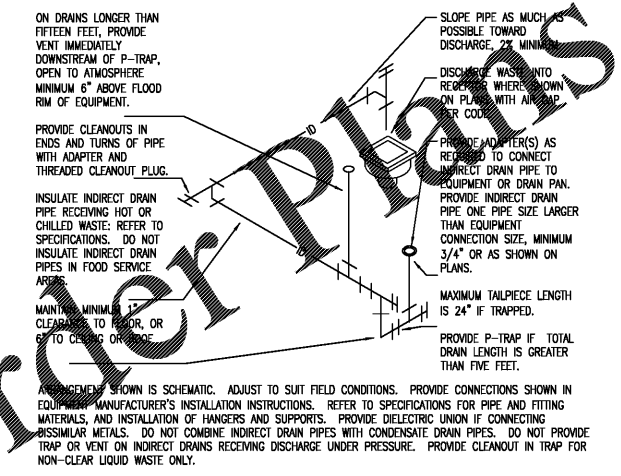

11 INDIRECT DRAIN INSTALLATION NOT TO SCALE

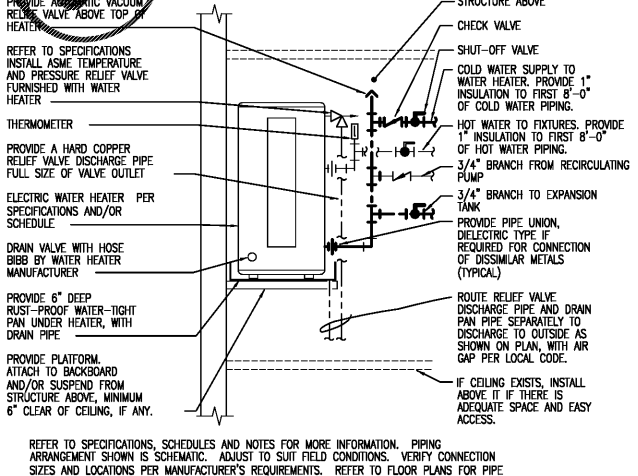

12 ELECTRIC WATER HEATER OVERHEAD NOT TO SCALE

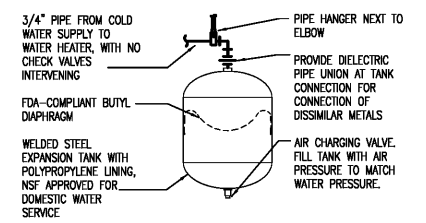

13 SMALL EXPANSION TANK NOT TO SCALE

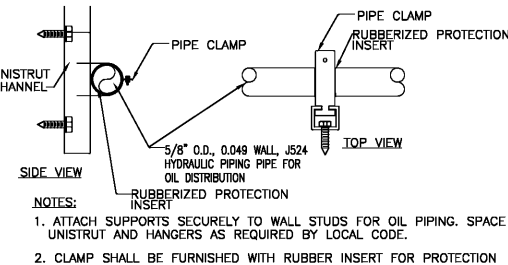

14 OIL PIPE MOUNTING DETAIL NOT TO SCALE

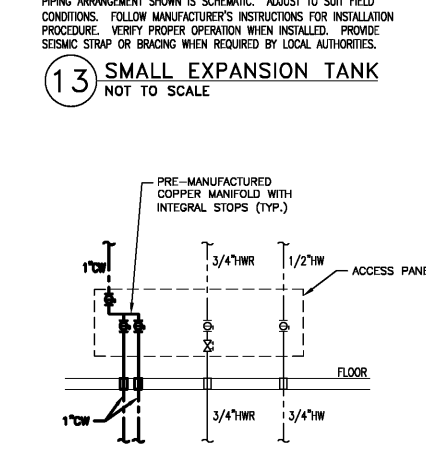

15 UPONOR MANIFOLD NOT TO SCALE

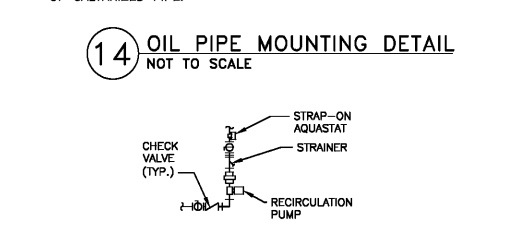

16 RECIRCULATING PUMP NOT TO SCALE

THIS SHEET IS PART OF THE CONSTRUCTION DOCUMENTS. OTHER SHEETS INCLUDING SPECIFICATIONS APPLY. THAT SHOWN HEREON IS SCHEMATIC IN NATURE AND NOT TO BE USED AS A SHOP DRAWING. THEREFORE, INCLUDE ALL MODIFICATIONS REQUIRED TO CONFORM TO SITE CONDITIONS AND THE EQUIPMENT AND MATERIAL USED. VERIFY LOCATIONS AND DIMENSIONS OF ALL ARCHITECTURAL AND STRUCTURAL ELEMENTS AS SHOWN ON THEIR RESPECTIVE DOCUMENTS. THESE ELEMENTS ARE SHOWN FOR REFERENCE AND SHALL BE VERIFIED PRIOR TO CONSTRUCTION AND THE ENGINEER ASSUMES NO LIABILITY FOR THE ACCURACY OF THESE ELEMENTS. NO DESIGN RESPONSIBILITY IS ASSUMED FOR ANY PORTION OF THE WORK THAT THE PROFESSIONAL ENGINEER HAS NOT SIGNED AND SEALED PER STATE/PROVINCE REQUIREMENTS.



Christian Brothers Automotive  
Wickham Road  
Melbourne, Florida



Revisions  
1/23/20 - Prototype Update  
4/1/20 - City Comments  
4/9/20 - T2 Client Rev.

Project No. 19-097  
Drawn By: MDB  
Date: 03/06/20  
Sheet Title: PLUMBING DETAILS

Drawing No. P-5.01  
10RHS-11-2019

Dialectic

Dialectic Inc.  
310 W 20th Street, Suite 200  
Kansas City, MO 64108  
Florida Certificate of Authorization Number 8039  
T 816-997-9601  
F 816-997-9602  
DialecticEng.com  
Copyright 2020