

(RADIUS)

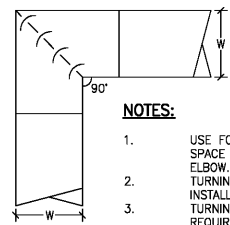

(SQUARE)

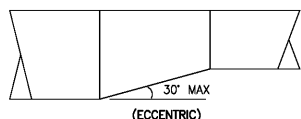

(ECCENTRIC)

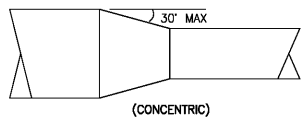

(CONCENTRIC)

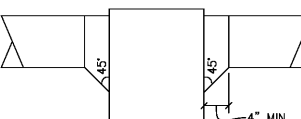

(TEE)

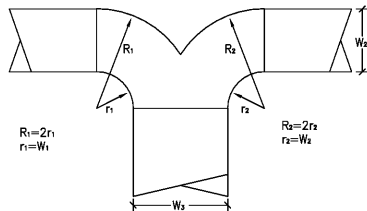

(RADIUS WYE)

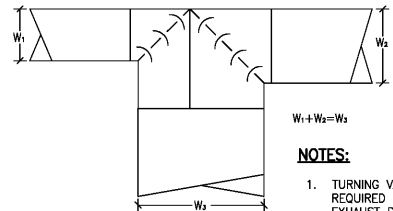

(SQUARE WYE)

DIVIDED FLOW BRANCHES

1 DUCTWORK DETAILS
M-5.1 SCALE: NONE

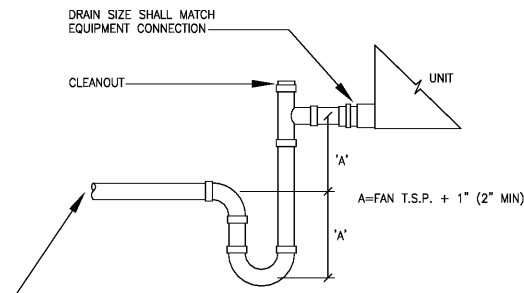

- NOTES:
1. SPILL CONDENSATE DRAIN ON SPLASH BLOCK ON ROOF ON DOWNHILL SIDE OF RTU.

2 CONDENSATE DRAIN
M-5.1 SCALE: NONE

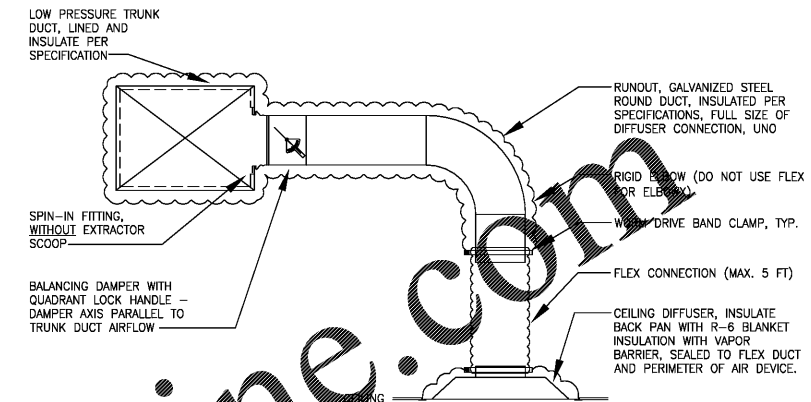

3 AIR DEVICE CONNECTION
M-5.1 SCALE: NONE

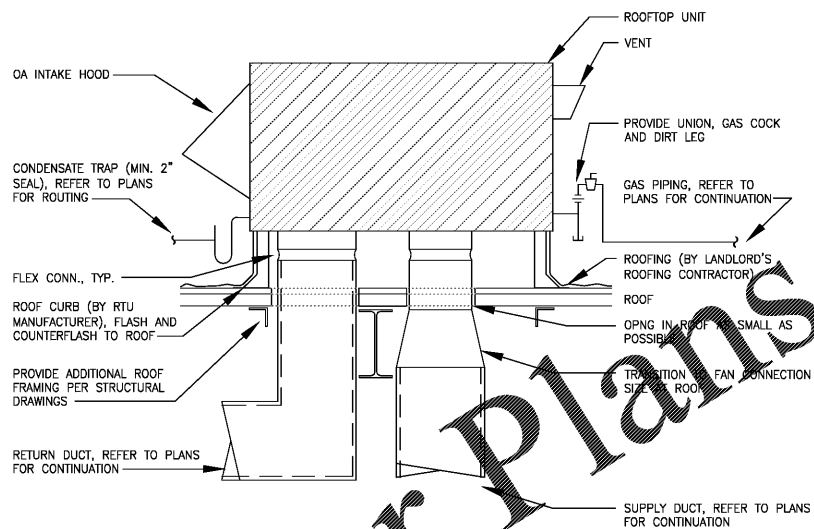

- NOTE:
1. SECURE RTU TO CURB PER MANUFACTURER'S RECOMMENDATIONS.
 2. RTU OR INTAKE HOOD SHOULD BE MINIMUM 10'-0" FROM ANY EXHAUST FAN DISCHARGE, PLUMBING VENT, ETC.

4 ROOFTOP UNIT - GAS HEAT
M-5.1 SCALE: NONE

Order Plans @

WWW.LDILine.com



DATE	06/16/20
BY	
CHECKED BY	
DESIGNED BY	
DRAWN BY	
SCALE	M-5.1
DATE	06/16/20
DRAWING NO.	
PROJECT NO.	
PROJECT NAME	WILD WOLF - COMMERCIAL DEVELOPMENT BOYD MORRIS ROAD & GA HWY 293 SPUR BARTOW COUNTY, GEORGIA 30120
CLIENT	BLACKWATER CONSTRUCTION 2160 SHELITE BLVD - SUITE 400 - DULUTH, GEORGIA 30097 VOICE: 404-542-3500 FAX: 404-542-3500 WWW.BCCONTRACTOR.COM
GENERAL CONTRACTOR	
ENGINEERING CONSULTANT	LDI Group Consulting Engineers, Inc. 1827 Powers Ferry Road Building 20, Suite 100 Atlanta, Georgia 30329 Tel: (770) 965-9638