

9 EXTERIOR WALL & SHEATHING/NAILER CONNECTION DETAIL
 SCALE: 3/4" = 1'-0"

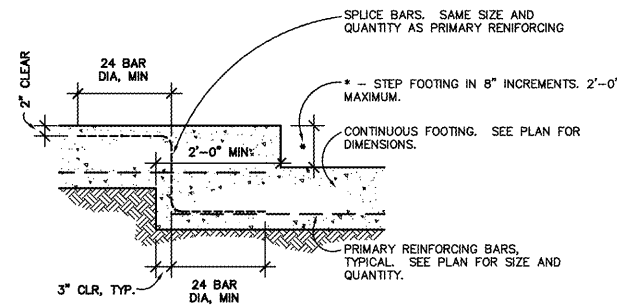

5 FOUNDATION STEP DETAIL
 SCALE: NONE

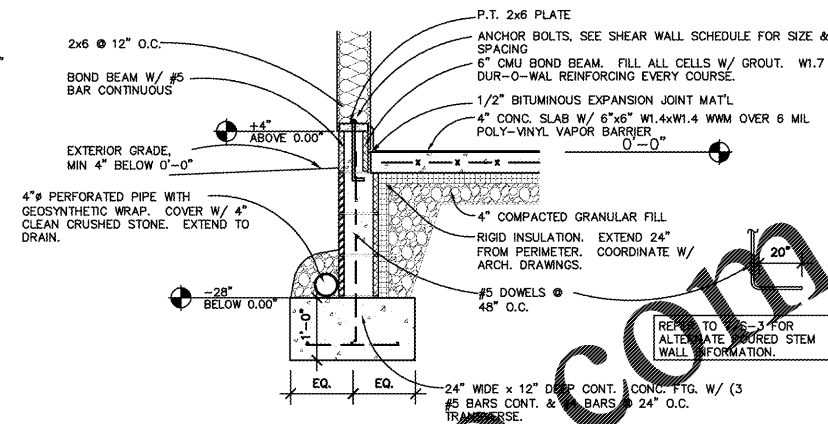

1 EXTERIOR WALL SECTION
 SCALE: 3/4" = 1'-0"

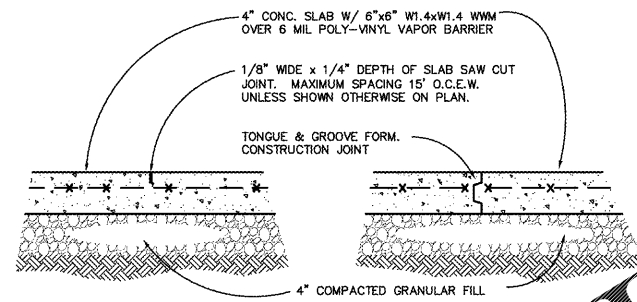

6 CONCRETE SLAB DETAIL
 SCALE: 1 1/2" = 1'-0"

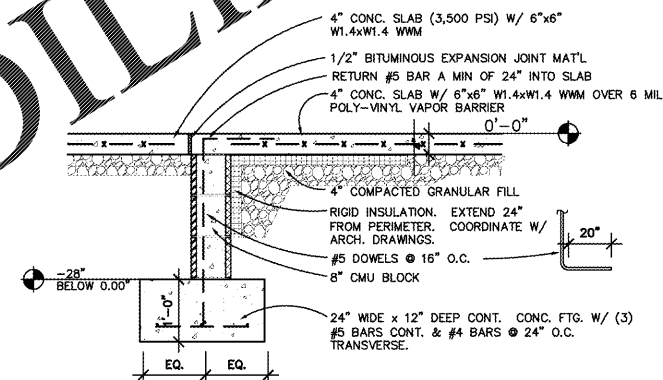

2 TURNED DOWN SLAB @ DOOR
 SCALE: 3/4" = 1'-0"

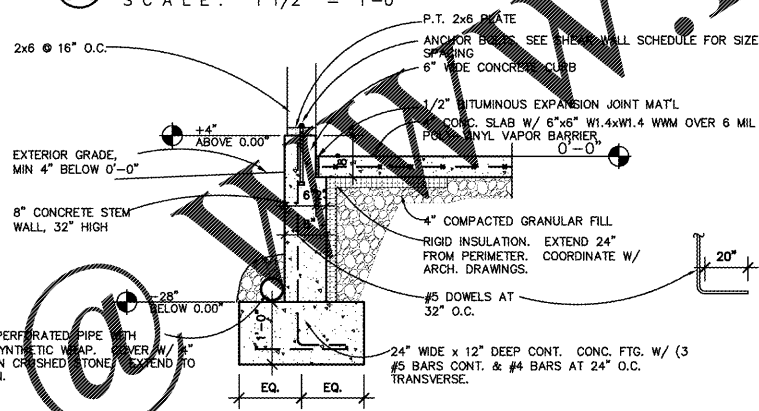

7 EXTERIOR WALL SECTION (ALTERNATE)
 SCALE: 3/4" = 1'-0"

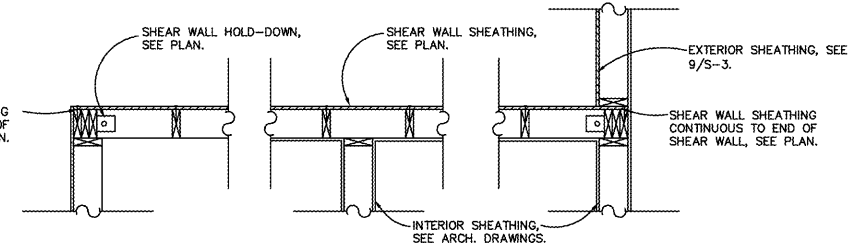

3 SHEAR WALL DETAIL
 SCALE: 3/4" = 1'-0"

10 NOT USED

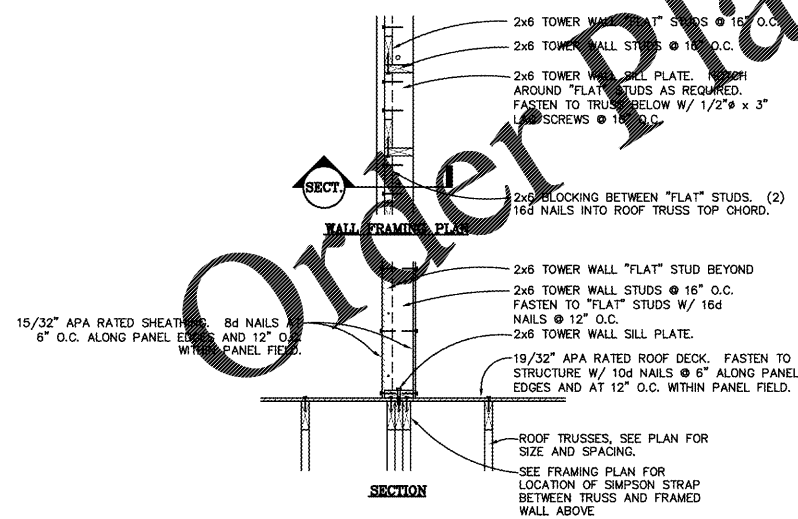

11 TOWER WALL FRAMING DETAIL
 SCALE: 3/4" = 1'-0"

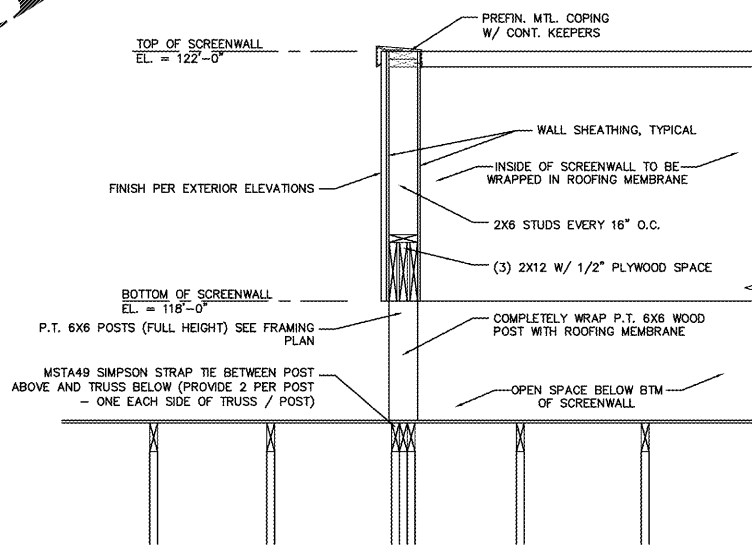

8 SCREENWALL FRAMING DETAIL
 SCALE: 3/4" = 1'-0"

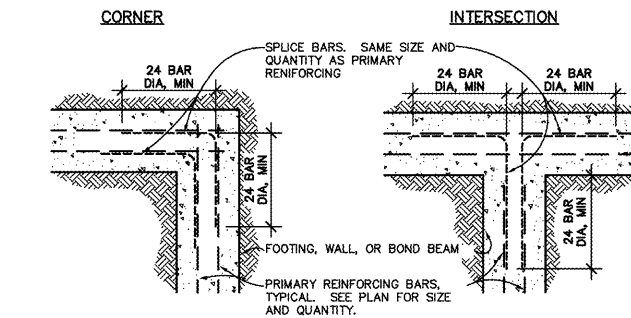

4 REINFORCING CONTINUITY DETAIL
 SCALE: NONE



A NEW LOCATION FOR
CAPTAIN D'S
 7525 STATE AVENUE
 KANSAS CITY, KS 66112
CAPTAIN D'S, LLC
 624 GRASSMERE PARK DRIVE,
 SUITE 30
 NASHVILLE, TN 37211

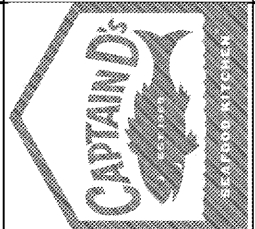

Job Number:

Revisions:

S-3

STRUCTURAL DETAILS