

JPL MANAGEMENT

ISSUE INFORMATION

REVISIONS

Nelco Architecture, Inc.

PROJECT INFORMATION

BOWLING GREEN, KY

DISHMAN LANE
BOWLING GREEN, KY 42101

PROJECT #:
20.0001760.000

SHEET INFORMATION

COOLER & COUNTER
SECTIONS & DETAILS

AW
DRAWN BY:
JN
REVIEWED BY:

SCALE:

AUTHORIZED FOR:
Permit / Bid

WALK IN BOX NOTES

NOTE:
SEE SHEET S-1 FOR FOUNDATION DETAILS AND ADDITIONAL NOTES.
G.C. TO COMPLY WITH ALL W.I.B. MANUFACTURER RECOMMENDATIONS
FOR PREPARATION AND INSTALLATION OF W.I.B. SLAB.

COOLER REFRIGERATION SHALL BE SIZED TO MAINTAIN 34 DEG. F.
FREEZER REFRIGERATION SHALL BE SIZED TO MAINTAIN -10 DEG. F.
WALK-IN COOLER SHALL BE PROVIDED WITHOUT FLOOR. WALK-IN
FREEZER SHALL BE PROVIDED WITH 4" INSULATED FLOOR AND
INTERIOR RAMP AT DOOR.

THE WALK-IN MANUFACTURER WILL PROVIDE:
1) THE WALK-IN COOLER & FREEZER
2) REFRIGERATION EQUIP. SIZED TO MEET POPEYES REQUIREMENTS.
FACTORY ASSEMBLED AND WITH LOW AMBIENT CONTROLS.
INCLUDING ALL WIRING, REFRIGERATION PIPING, W/ REMOTE
UNITS MOUNTED ON S.S. RAILS LOCATED ON THE ROOF, AND
READY FOR FINAL CONNECTION TO ALL NECESSARY UTILITIES.
3) DELIVERY OF THE BOXES
4) CONTRACTOR TO INSTALL WALK-IN BOX AND REFRIG.

IT SHALL BE THE RESPONSIBILITY OF THE G.C. TO CONTACT WALK-IN
BOX PROVIDER AND OBTAIN A COPY OF THE SHOP DRAWINGS FOR
THIS PROJECT PRIOR TO ROUGH IN OF UTILITIES. FAILURE TO OBTAIN
SHOP DRAWINGS PRIOR TO ROUGH IN WILL NOT RESULT IN EXTRA
CHARGES TO THE OWNER FOR RELOCATION OF UTILITIES.

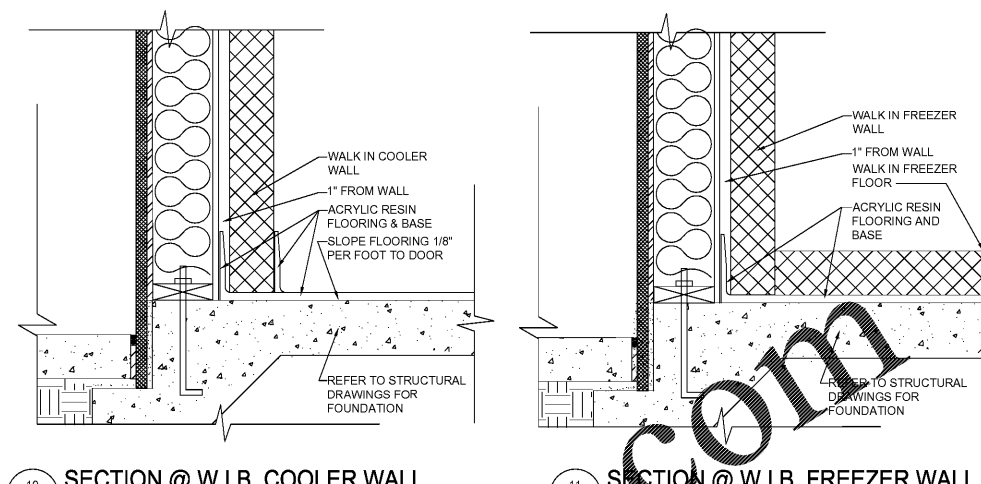

10 SECTION @ W.I.B. COOLER WALL

11 SECTION @ W.I.B. FREEZER WALL

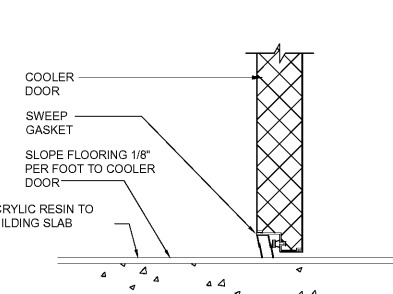

7 SECTION @ W.I.B. DOOR

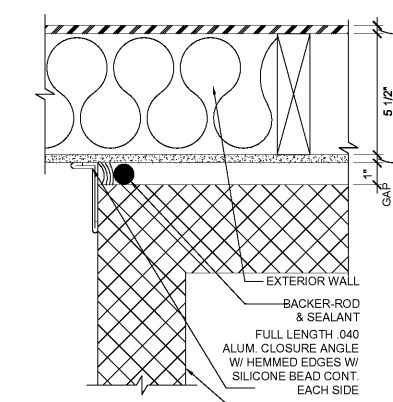

8 FLASHING DETAIL @ W.I.B.

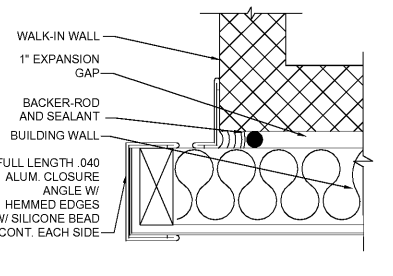

9 FLASHING DETAIL @ W.I.B.

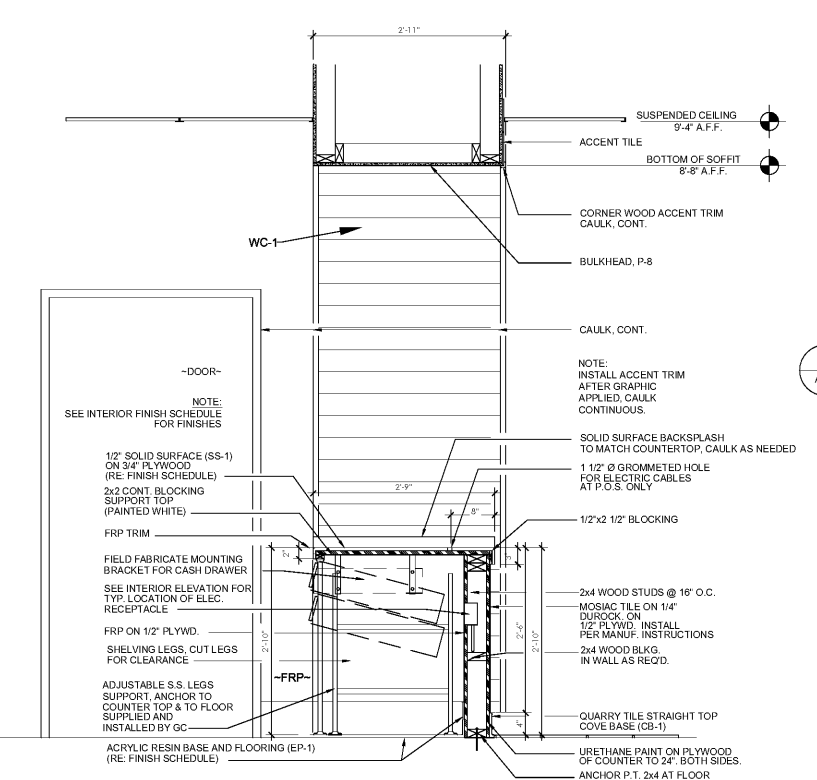

1 SECTION @ FRONT COUNTER

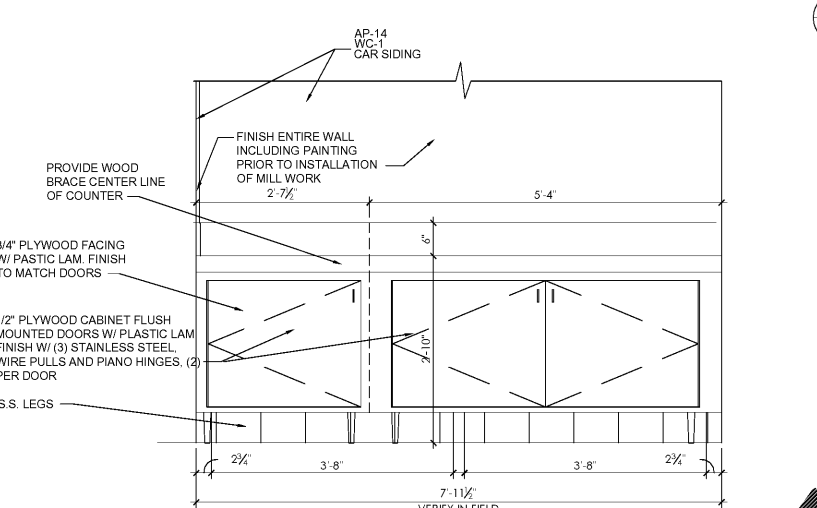

2 SELF-SERVE COUNTER ELEVATION

*SUPPLIED BY KITCHEN SUPPLIER
*SEE K3 DRAWING FOR BEVERAGE COUNTER AND ALTERNATE FREESTYLE CONFIGURATION

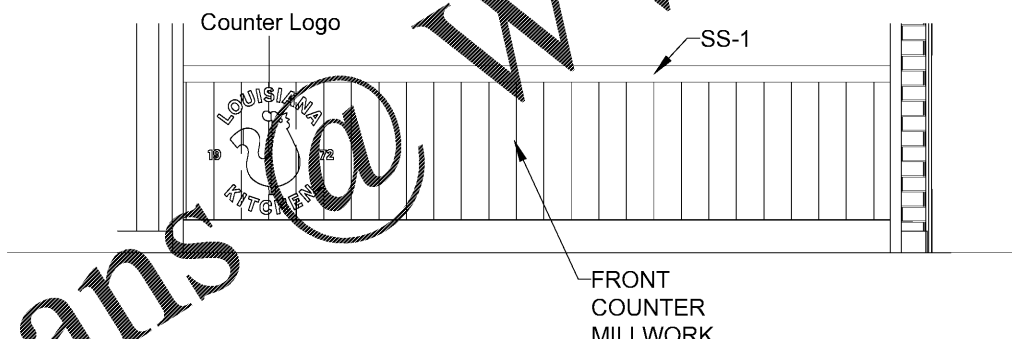

3 FRONT COUNTER ELEVATION

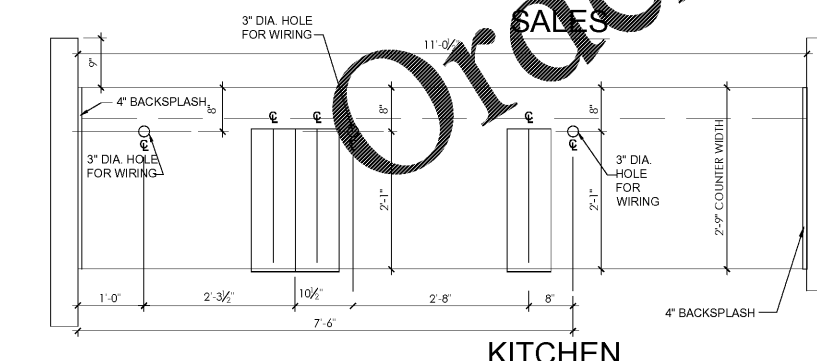

4 FRONT COUNTER CUT-OUTS

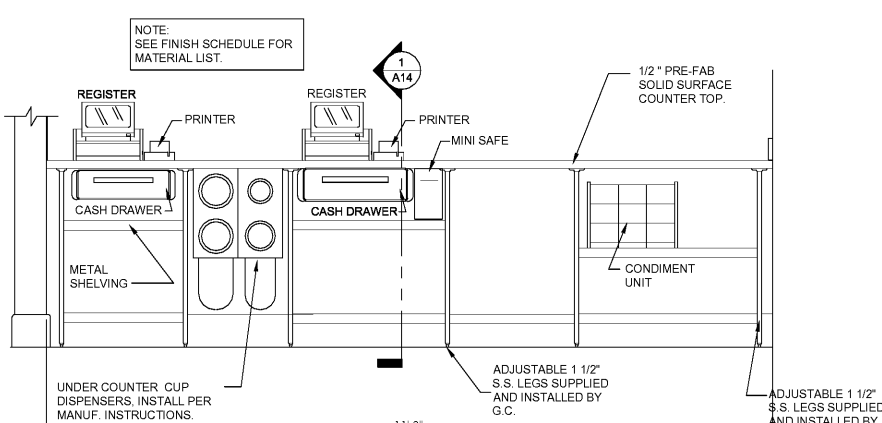

5 FRONT COUNTER REAR ELEVATION

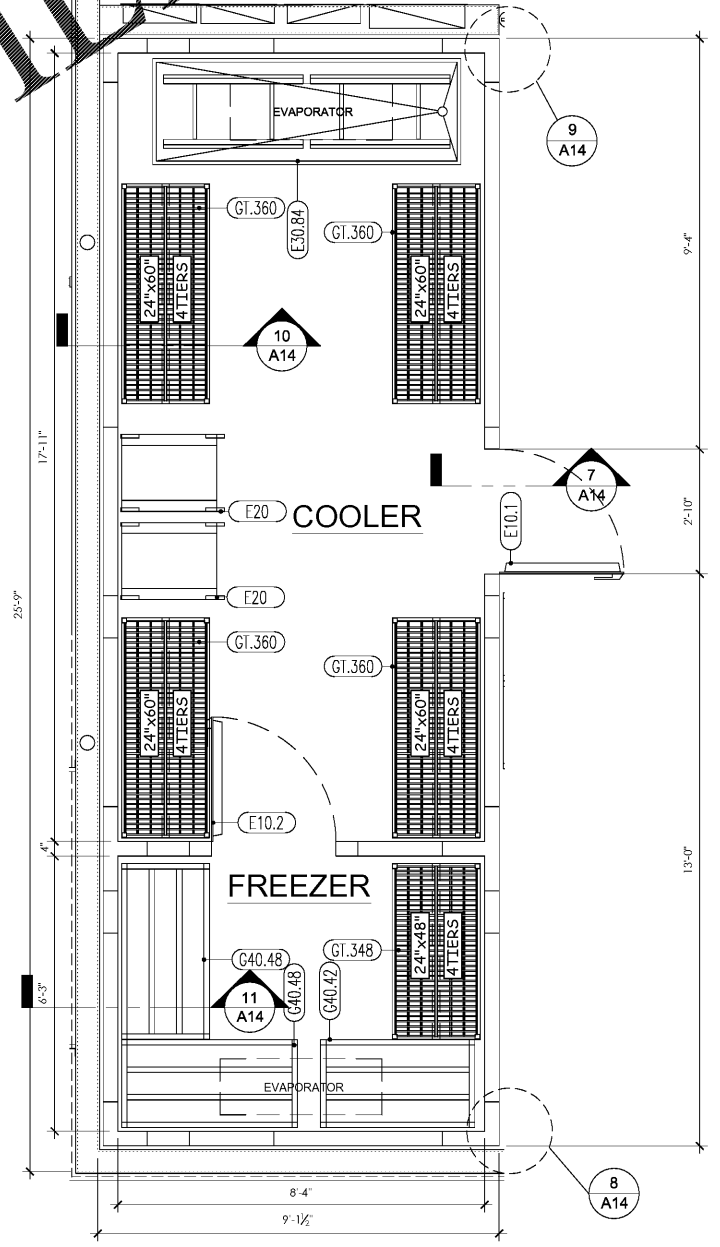

6 WALK IN FLOOR PLAN

Order Plans @ SALES

WWW.LDILine.com