

9 SECTION DETAIL
1 1/2" = 1'-0"

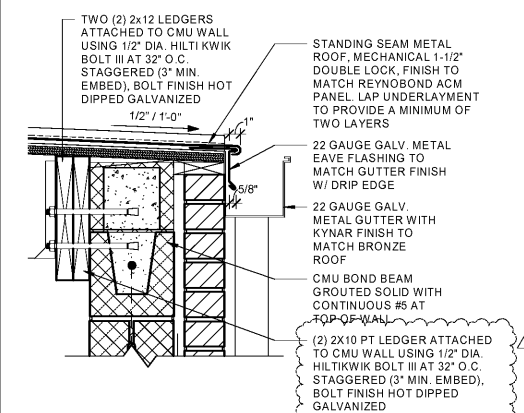

8 SECTION DETAIL
1 1/2" = 1'-0"

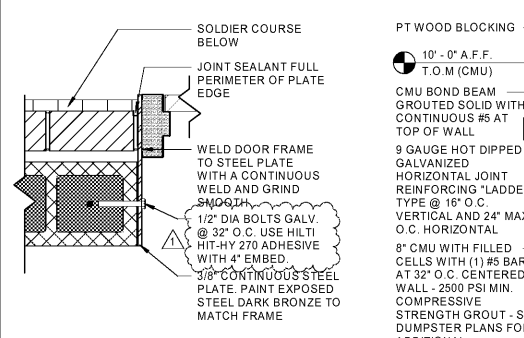

11 DOOR JAMB
1 1/2" = 1'-0"

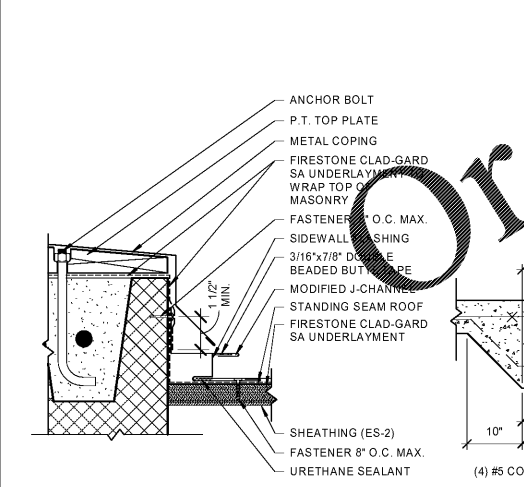

10 SECTION DETAIL
3" = 1'-0"

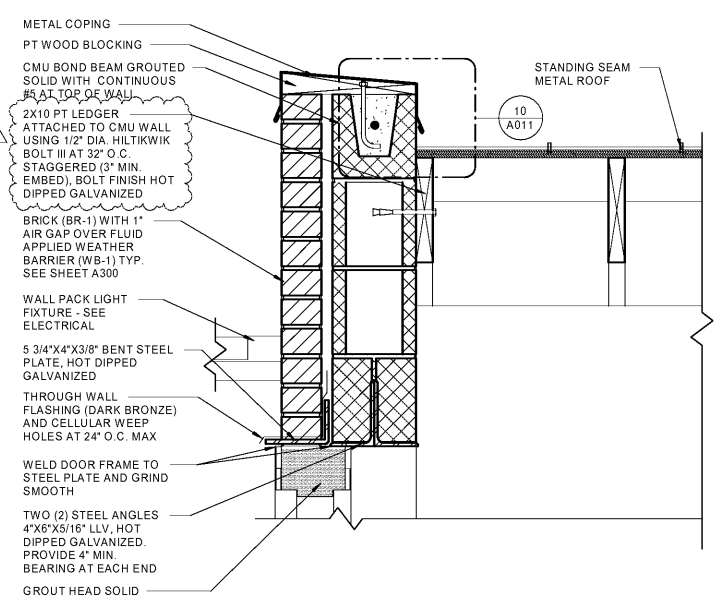

7 SECTION DETAIL
1 1/2" = 1'-0"

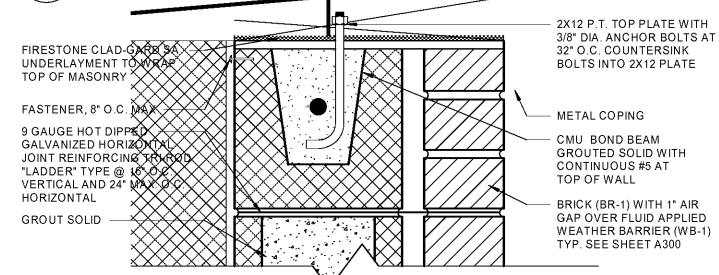

6 SECTION DETAIL
3" = 1'-0"

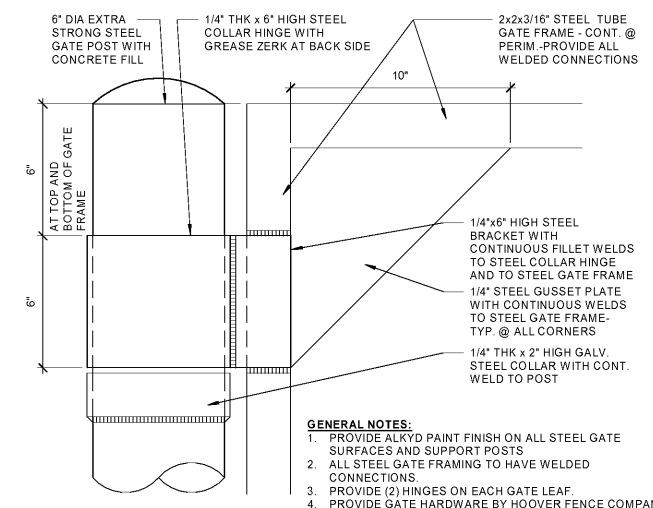

GATE POST DETAIL
3" = 1'-0"

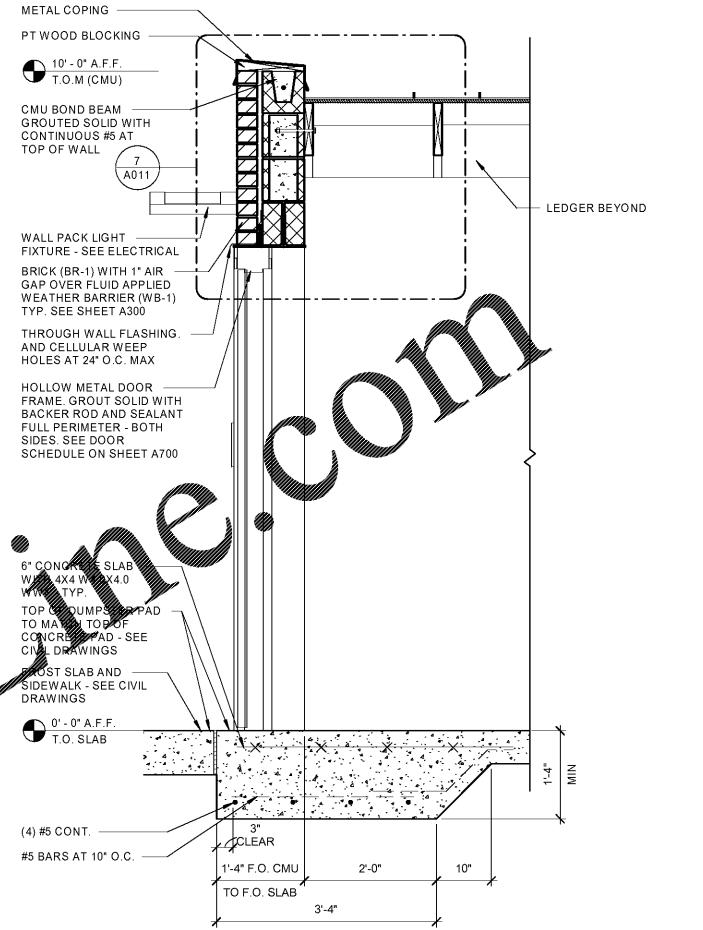

4 DUMPSTER SIDE WALL
3/4" = 1'-0"

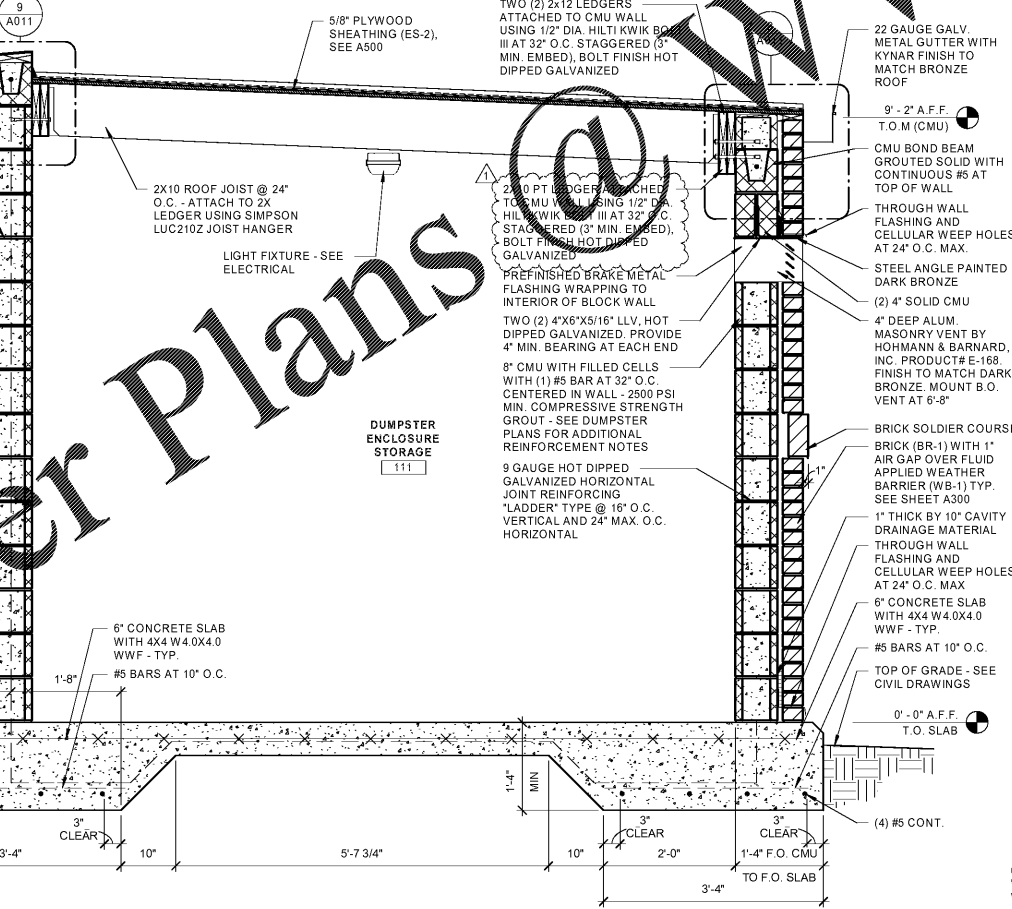

3 DUMPSTER ENCLOSURE REAR WALL
3/4" = 1'-0"

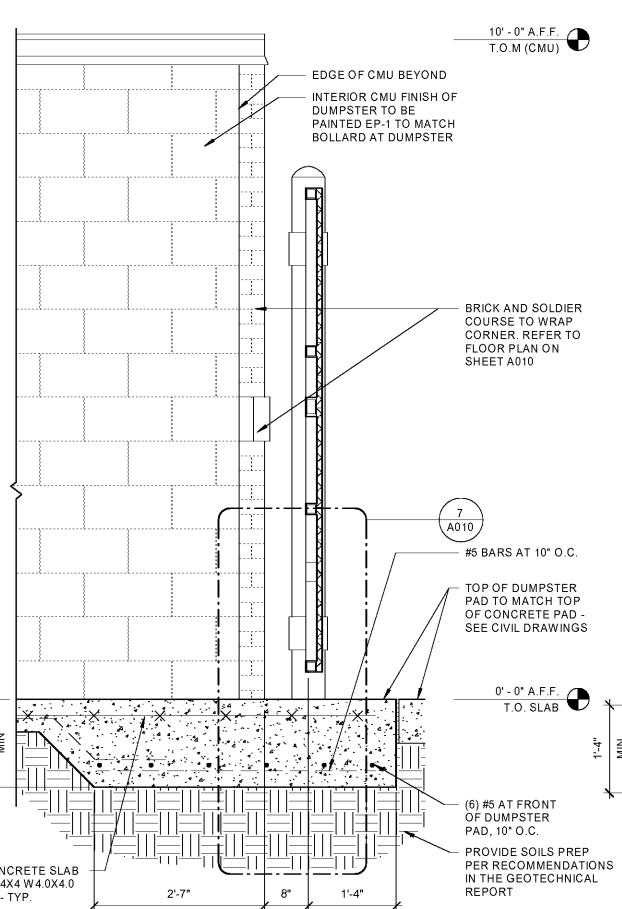

2 DUMPSTER FRONT WALL
3/4" = 1'-0"

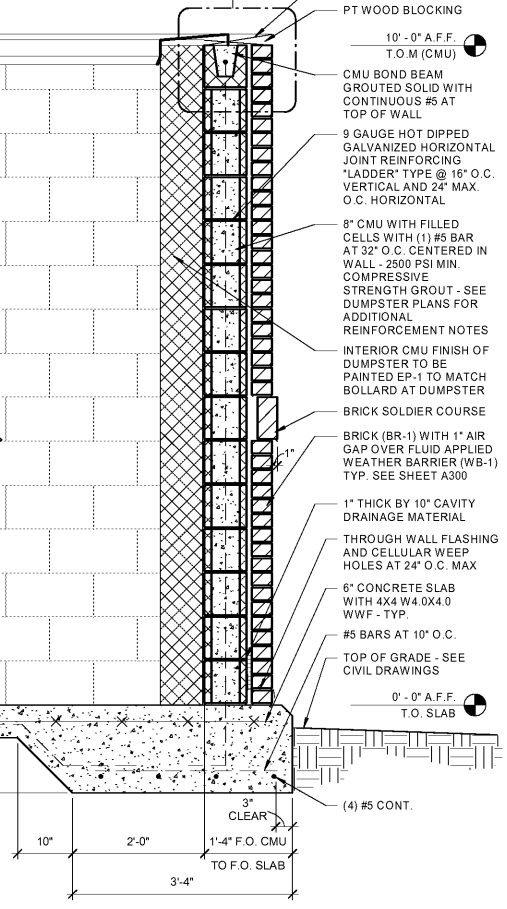

1 DUMPSTER SIDE WALL
3/4" = 1'-0"

Order Plans @ WWW.LDLINE.COM

ISSUE/REVISION RECORD

DATE	DESCRIPTION
01/25/19	PERMIT SET
03/16/20	REFRESH TO 2020.0113