

**1 CATCH CURB DETAIL @ CONCRETE SLAB**  
SD6 NTS

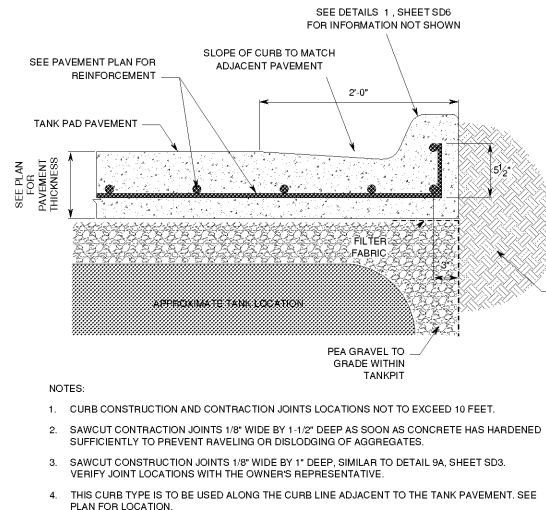

**2 TANK AREA CURB DETAIL**  
SD6 NTS

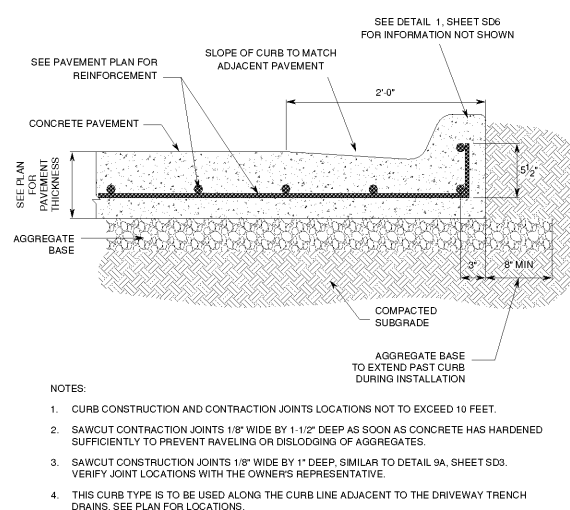

**3 MONOLITHIC CURB DETAIL**  
SD6 NTS

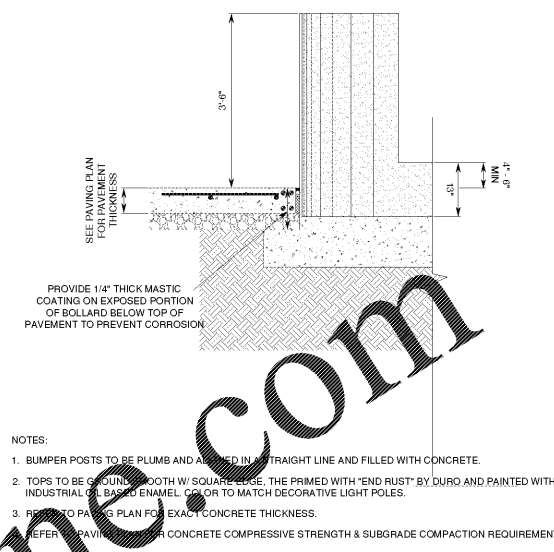

**4 DIESEL CANOPY BOLLARD DETAIL**  
SD6 NTS

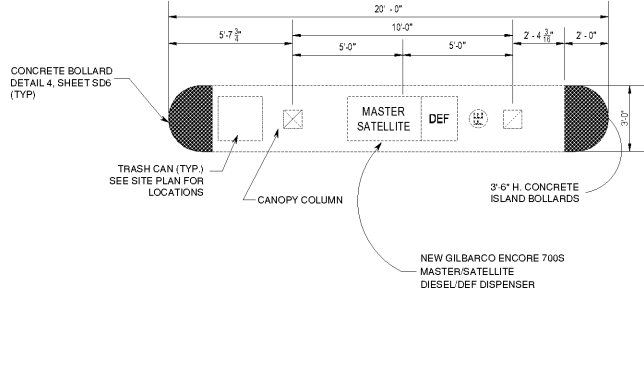

**5 EDO DISPENSER ISLAND DETAIL**  
SD6 NTS

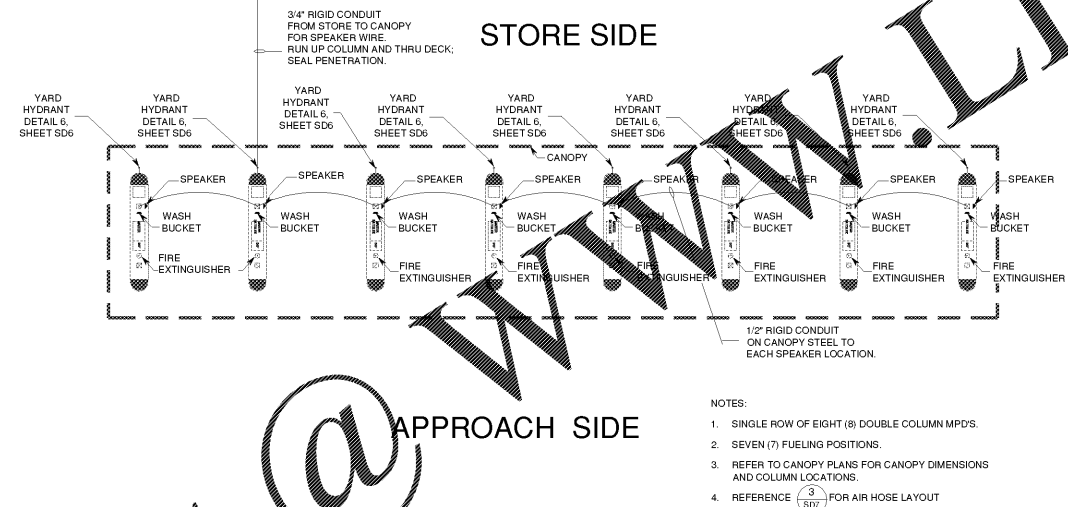

**6 EDO CANOPY ACCESSORY LAYOUT**  
SD6 NTS

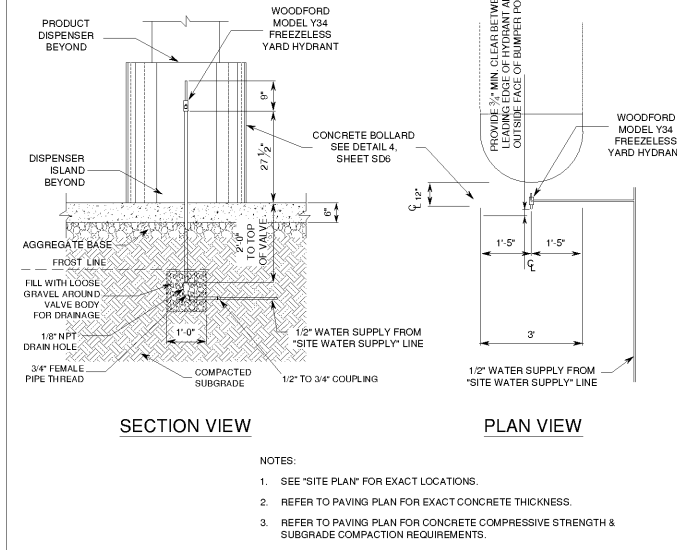

**7 YARD HYDRANT DETAIL**  
SD6 NTS

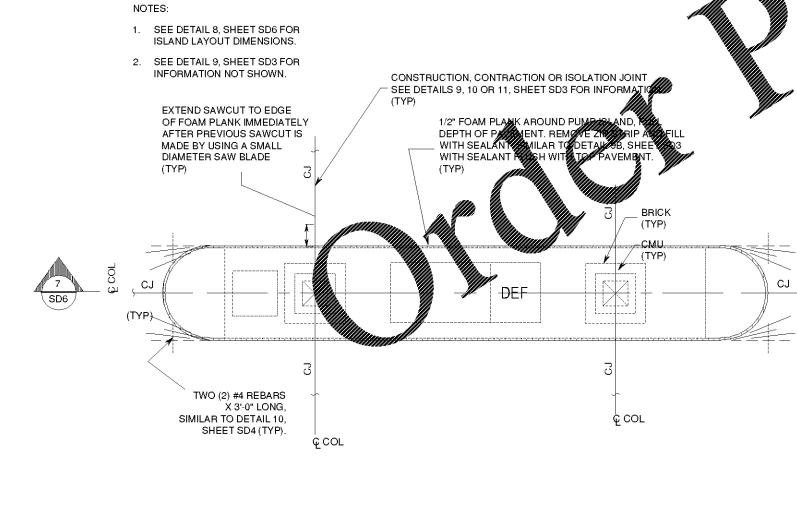

**8 CONCRETE DETAIL @ DISPENSER ISLAND**  
SD6 NTS

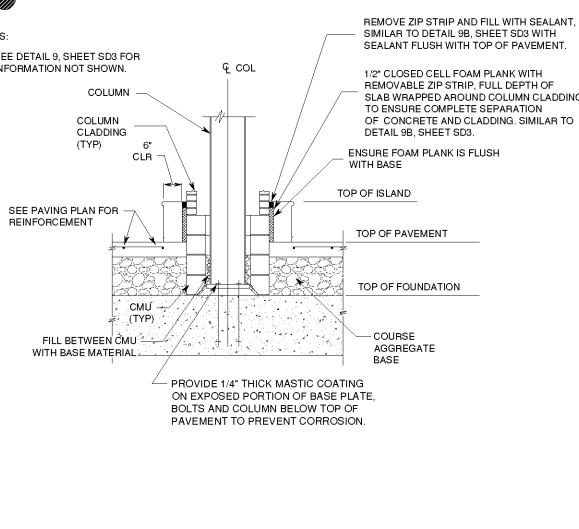

**9 CANOPY COLUMN SECTION WITH COLUMN CLADDING**  
SD6 NTS

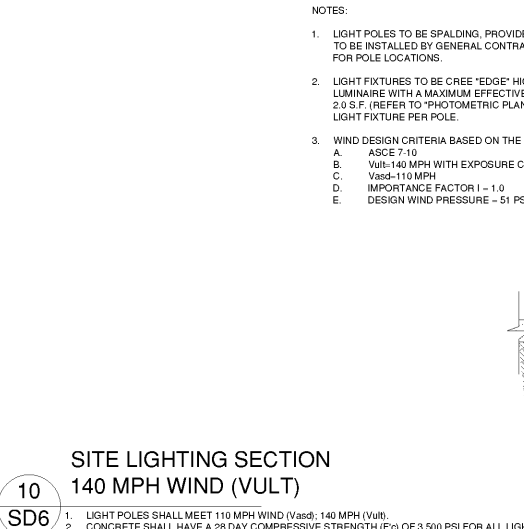

**10 SITE LIGHTING SECTION 140 MPH WIND (VULT)**  
SD6 NTS

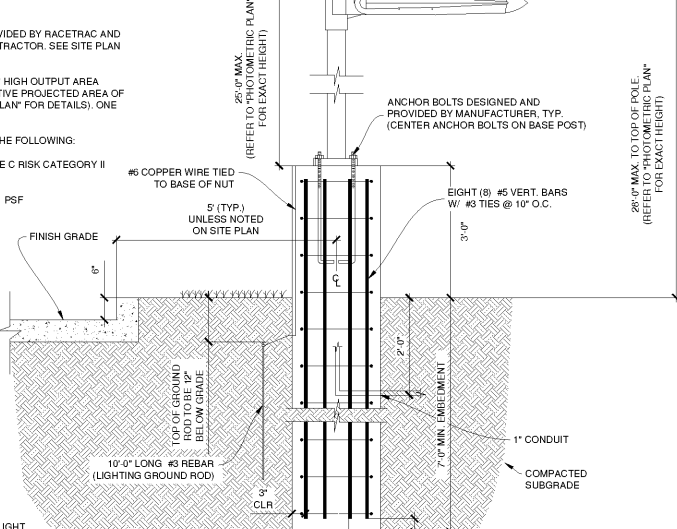

<p>W&amp;A Engineering Civil Engineering - Landscape Architecture Surveying - Soil and Environmental Consulting Traffic Engineering - Technical Engineering</p>		THESE PLANS ARE ORIGINAL COPYRIGHT LAWS. ANY USE OF SAME WITHOUT THE EXPRESSED WRITTEN PERMISSION OF RACETRAC PETROLEUM, INC. IS PROHIBITED.
<p>RACETRAC PETROLEUM, INC. 200 GALLERIA PARKWAY SE SUITE 500 ATLANTA, GA 30359 (770) 431-7600</p>		DRAWN-BY: AGRUNER DATE: 3/3/2020 SCALE: DRAWING NAME: RT Details 17293.dwg SHEET NO.: SD6 VERSION:
RACETRAC STANDARD DETAILS RACETRAC 316@81 839 Loganville Highway Bethlehem, Georgia Barrow County		1. REVISED PER RACETRAC COMMENTS NO.