

1 CATCH CURB DETAIL @ CONCRETE SLAB
SD1 NTS

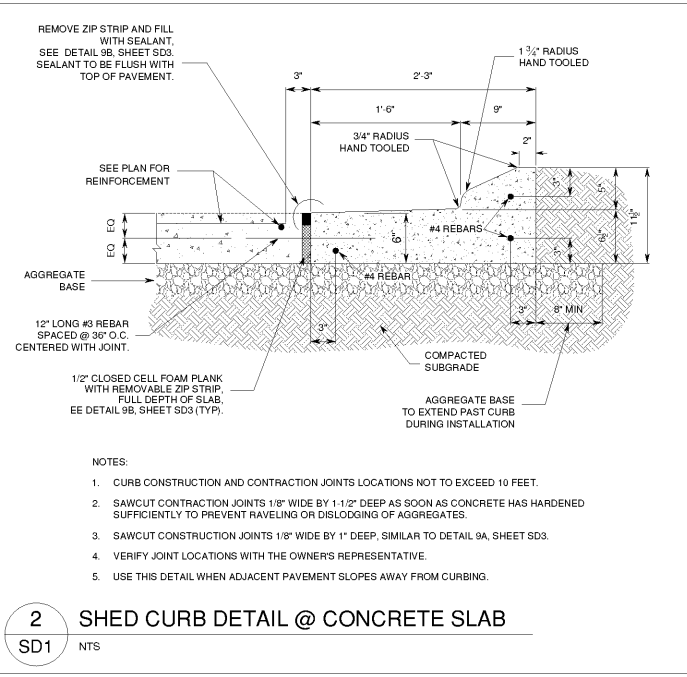

2 SHED CURB DETAIL @ CONCRETE SLAB
SD1 NTS

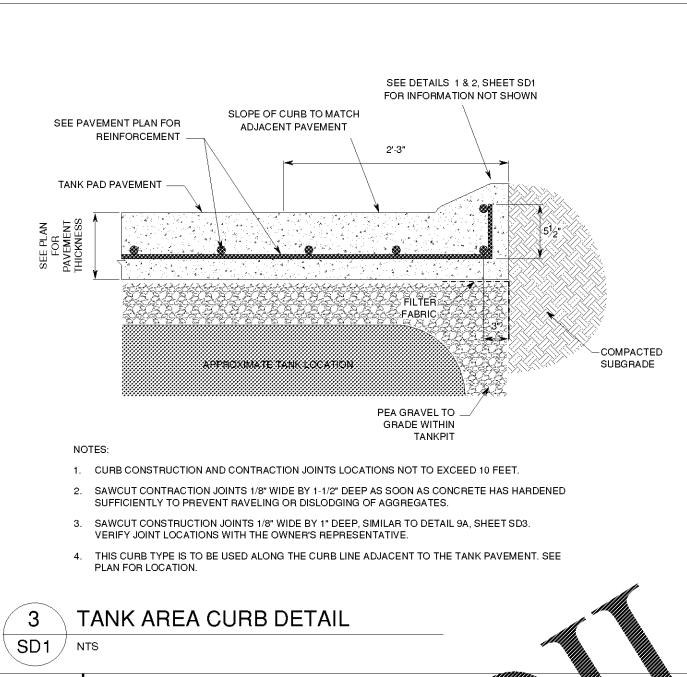

3 TANK AREA CURB DETAIL
SD1 NTS

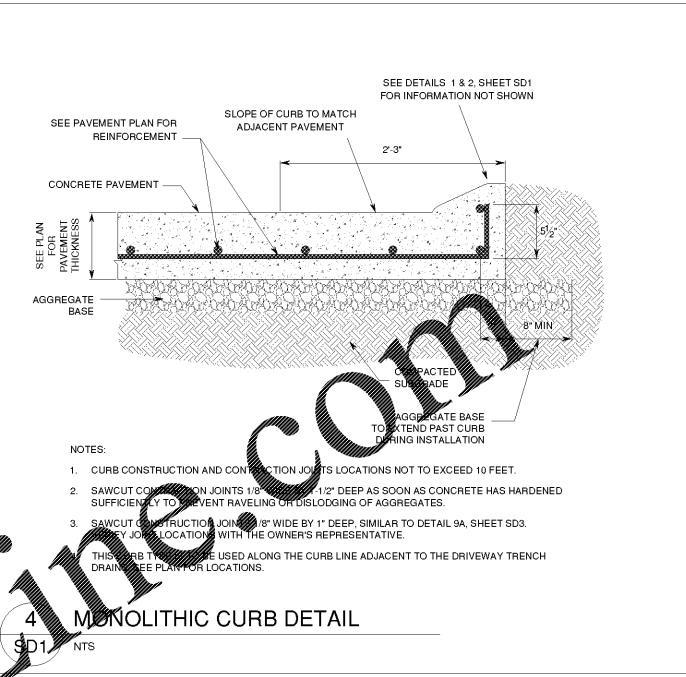

4 MONOLITHIC CURB DETAIL
SD1 NTS

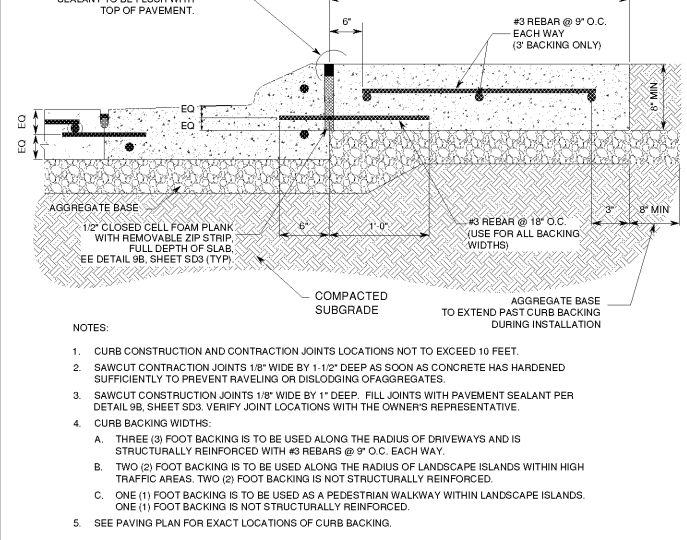

5 CONCRETE BACKING FOR ON-SITE CURB
SD1 NTS

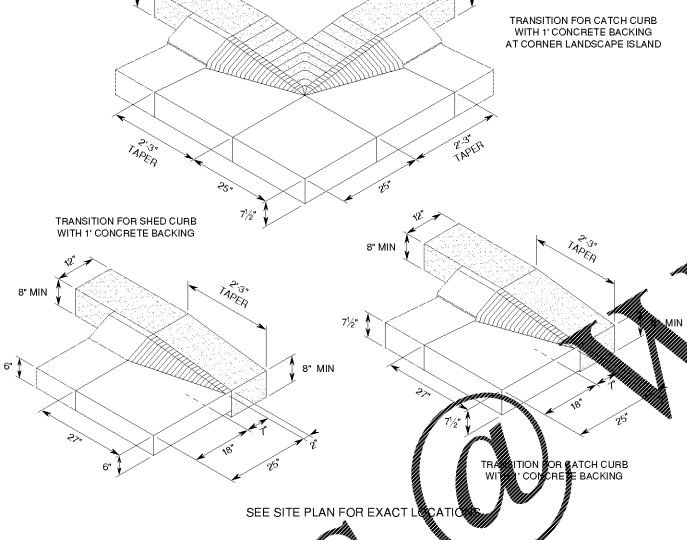

6 CURB TRANSITION DETAILS
SD1 NTS

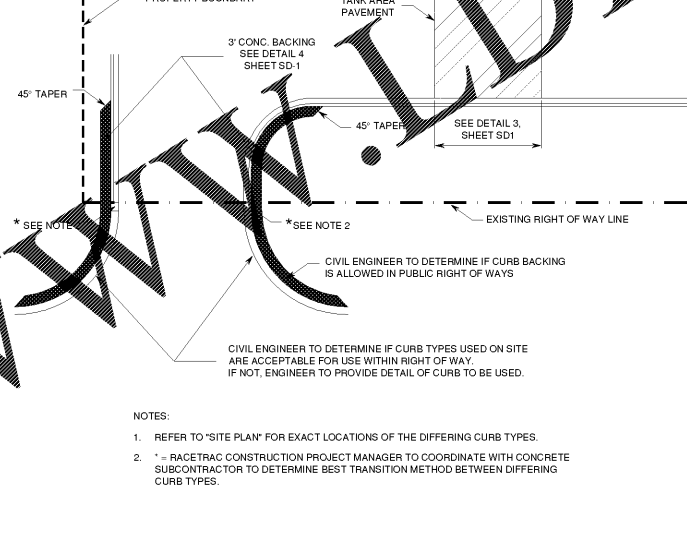

7 CURB LAYOUT PLAN VIEW
SD1 NTS

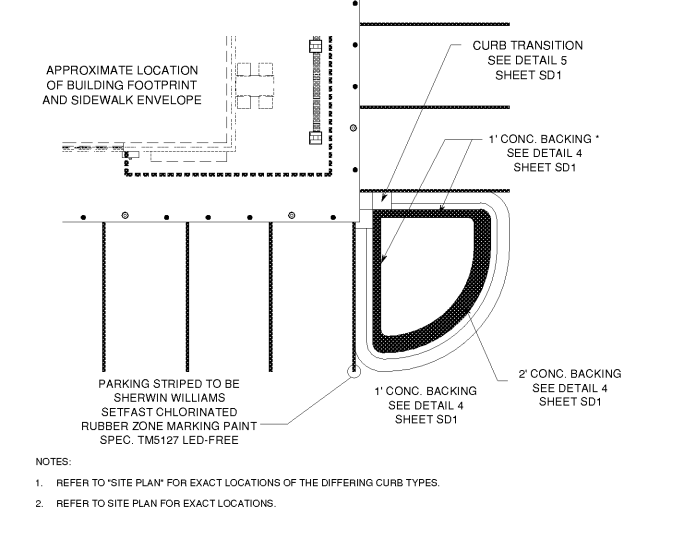

8 CONCRETE BACKING PLAN VIEW
SD1 NTS

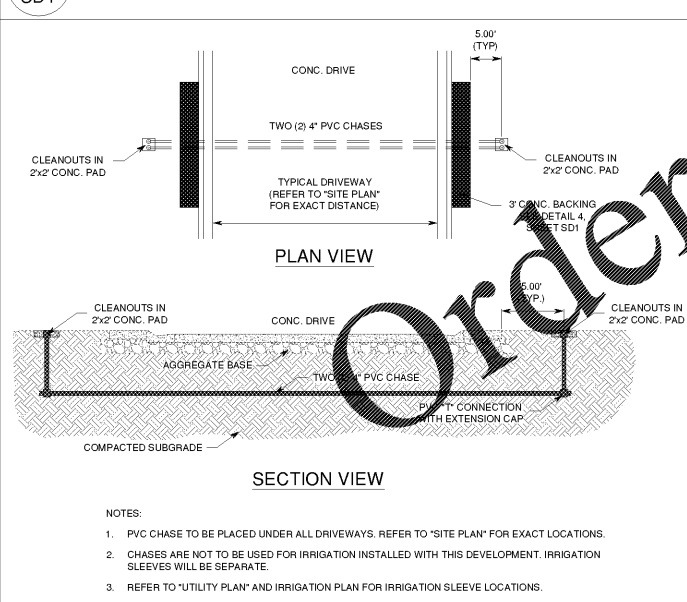

9 PVC CHASE DETAIL
SD1 NTS

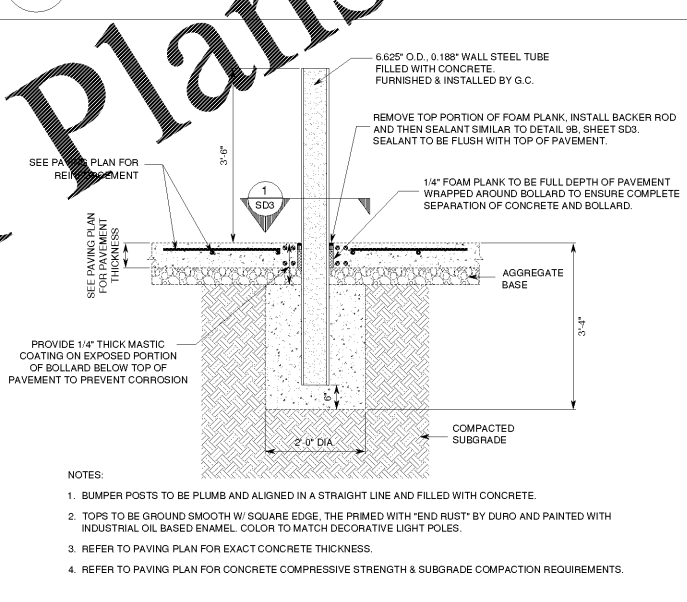

10 CANOPY BOLLARD DETAIL
SD1 NTS

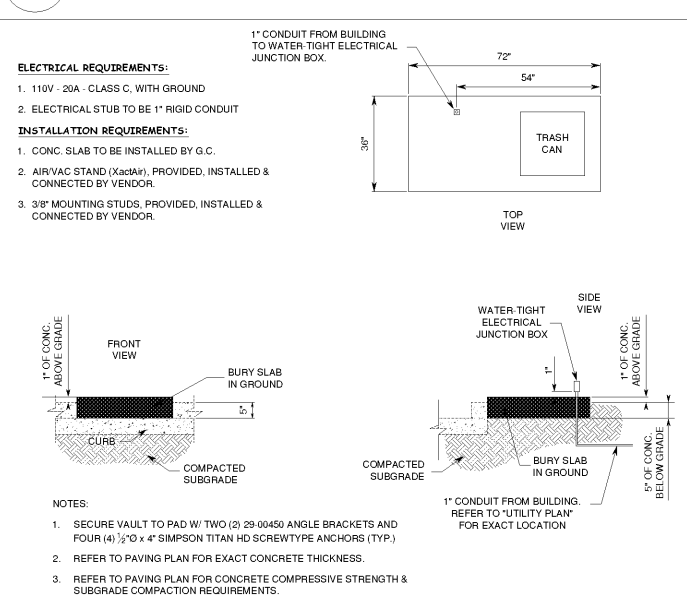

11 AIR/VAC SERVICE DETAIL
SD1 NTS

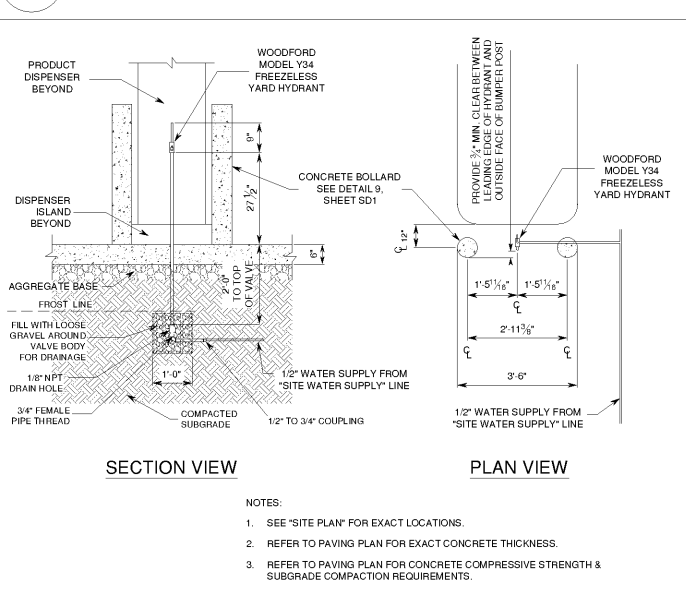

12 YARD HYDRANT DETAIL
SD1 NTS

03.03.2020	REVISED PER RACETRAC COMMENTS	NO.	DATE
02.13.2020	REVISED PER RACETRAC COMMENTS	2	02.11.2019
	REVISED PER RACETRAC COMMENTS	1	

W&A Engineering
CIVIL ENGINEERING - LANDSCAPE ARCHITECTURE
SURVEYING - SITE AND ENVIRONMENTAL CONSULTING
TRAFFIC ENGINEERING - TECHNICAL DRAFTING

THESE PLANS ARE ORIGINAL WORK. ANY REPRODUCTION OR USE OF SAME WITHOUT THE WRITTEN PERMISSION OF RACETRAC PETROLEUM, INC. IS PROHIBITED.

Racetrac
RACETRAC PETROLEUM, INC.
200 GALLERIA PARKWAY SE
SUITE 500 ATLANTA, GA 30359
(770) 431-7600

RACETRAC STANDARD DETAILS
RACETRAC 316@81
839 Loganville Highway
Bethlehem, Georgia
Barrow County

DRAWN-BY: AGRUNER
DATE: 3/3/2020
SCALE:
DRAWING NAME: RT Details 17293.dwg
SD1
SHEET NO. VERSION