



SCOPE DOCUMENTS

The Contract Documents Issued for (Conceptual Design, Schematic Design, Design Development, Permit Construction Documents or Other Issuance up to Issued for Construction) are intended to be at that level of (Construction Manager, Contractor, Design/Builder) is responsible for complete and coordinated pricing (and execution) of the Work, and shall include items necessary for the proper execution and completion of the Work, as shown, specified, reasonably inferred or required for a complete components and materials shall comply with national, state and local code shall inform the Owner and Architect, in timely fashion, of any discovered omissions, inaccuracies or errors in the Contract Documents.

ISSUANCES

Table with columns: No., Drawing Issue Description, Date. Contains entries for LDC SUBMISSION and DESIGN DEVELOPMENT.

GAS EQUIPMENT SCHEDULE table with columns: MARK, DESCRIPTION, MBTU/HI.

GAS PRESSURE REGULATOR SCHEDULE table with columns: MARK, LOCATION, CONNECTED LOAD, INLET PRESSURE, OUTLET PRESSURE, REMARKS.

(1) SEE DETAIL 4/PO.01

FIXTURE SCHEDULE table with columns: MARK, DESCRIPTION, PIPE SIZE, REMARKS.

NOTES: (1) SEE ARCHITECTURAL PLANS FOR MOUNTING HEIGHT. (2) PROVIDE 1/2\"

ABBREVIATIONS table with columns: CW, HW, HWC, S, V, W, RW, ERW, CO, WCO, FD, FS, HD, WH, ABV, CLG, BEL, H.B., I.E., WHA, Y.P., P.R.V.

PLUMBING SYMBOLS table with columns: Symbol description, Legend.

- GENERAL NOTES - PLUMBING
1. DRAWINGS ARE DIAGRAMMATIC ONLY. REFER TO ARCHITECTURAL DRAWINGS FOR BUILDING DIMENSIONS AND EXACT LOCATIONS AND ELEVATIONS OF ALL FIXTURES AND EQUIPMENT.
2. SCOPE OF WORK ON PLUMBING DRAWINGS DEFINE LIMIT OF ARCHITECTURAL WORK. PLUMBING WORK MAY EXTEND BEYOND THESE LIMITS FOR POINTS OF CONNECTION.

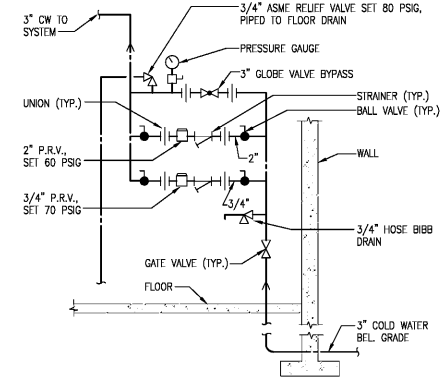

1 PRESSURE REDUCING STATION SCALE: NONE

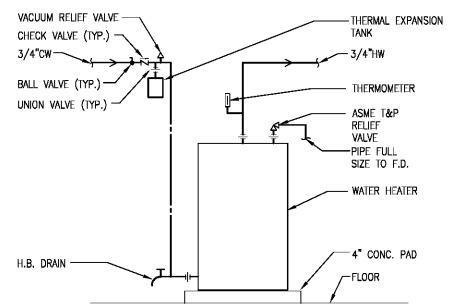

3 ELECTRIC WATER HEATER PIPING SCALE: NONE

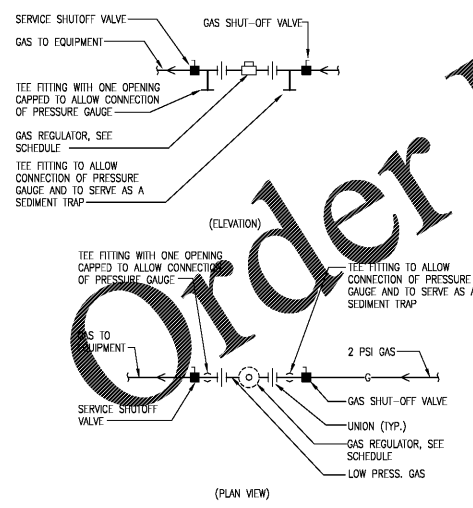

4 GAS REGULATOR PIPING SCALE: NO SCALE

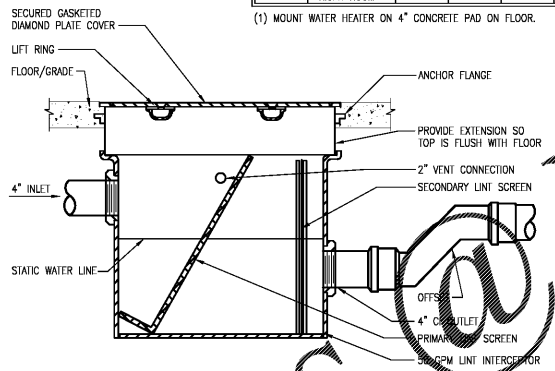

2 LINT INTERCEPTOR DETAIL SCALE: NONE

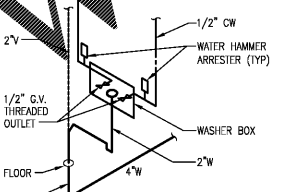

5 WASHER BOX PIPING SCALE: NONE

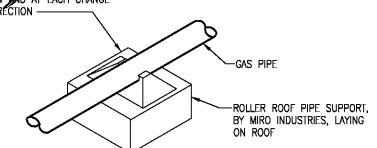
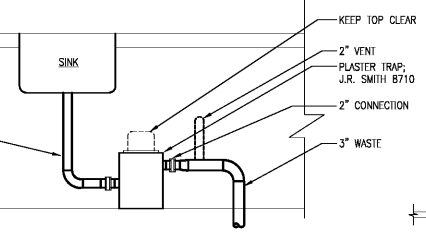
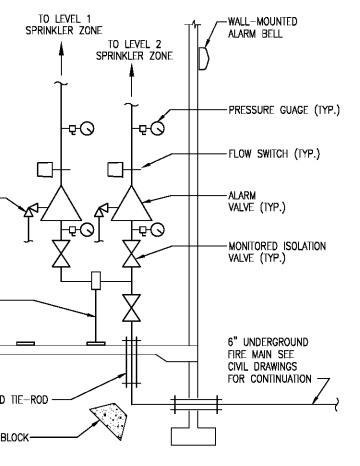

Table for ROOF GAS PIPE SUPPORT with columns: PIPE SIZE, SUPPORT SPACING.



7 PLASTER TRAP PIPING SCALE: NO SCALE



8 SPRINKLER ZONE RISER SCALE: NONE



9 TYPICAL SPRINKLER DROP PIPING SCALE: NO SCALE

MIXING VALVE SCHEDULE table with columns: MARK, LOCATION, SERVES, TYPE, CAPACITY, ALLOWABLE PRESSURE DROP, ASSE STANDARD, DESIGN BASIS, REMARKS.

ELECTRIC WATER HEATER SCHEDULE table with columns: MARK, LOCATION, SIZE, VOLTAGE, KW, DESIGN BASIS, REMARKS.

(1) MOUNT WATER HEATER ON 4\"

