

TOILET ROOM FIXTURE AND ACCESSORY MOUNTING

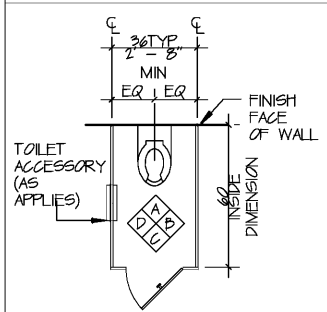

1 - TYPICAL RESTROOM STALL PLAN

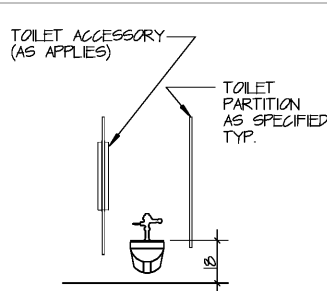

1/A - FIXTURE ELEVATION

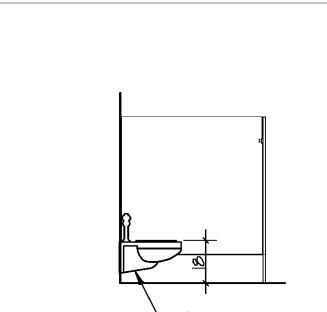

1/B - SIDE ELEVATION

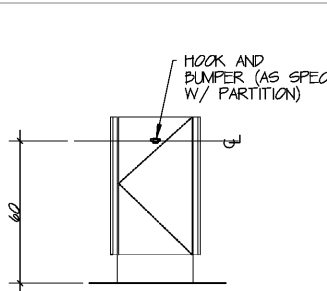

1/C - DOOR ELEVATION

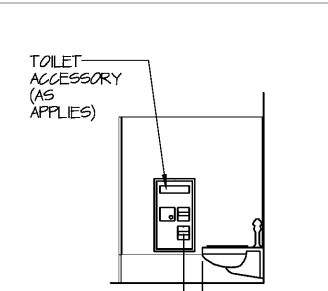

1/D - SIDE ELEVATION

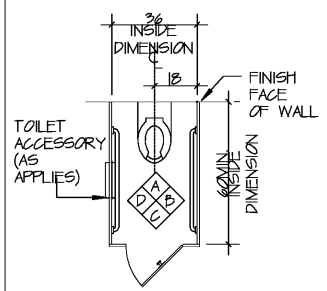

2 - TYPICAL AMBULATORY STALL PLAN

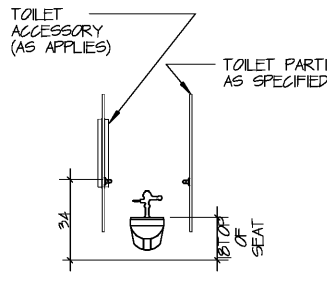

2/A - FIXTURE ELEVATION

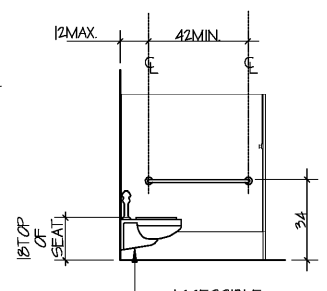

2/B - SIDE ELEVATION

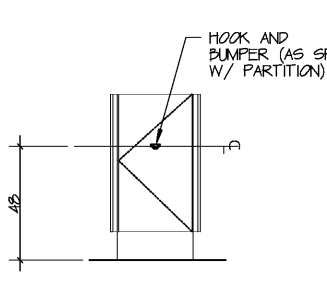

2/C - DOOR ELEVATION

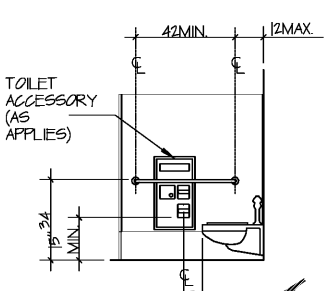

2/D - SIDE ELEVATION

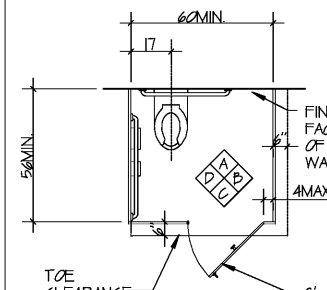

3 - TYPICAL ACCESSIBLE STALL PLAN

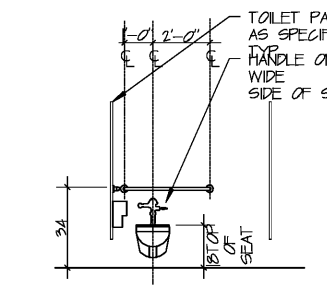

3/A - FIXTURE ELEVATION

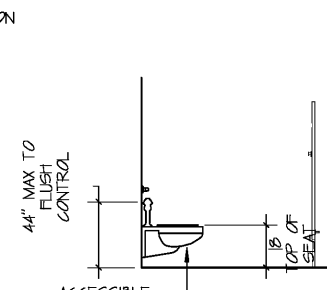

3/B - SIDE ELEVATION

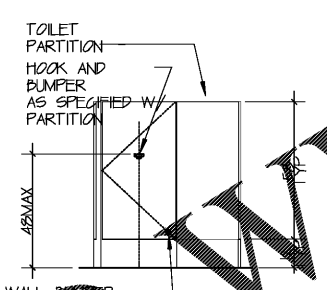

3/C - DOOR ELEVATION

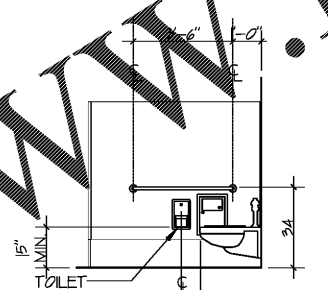

3/D - SIDE ELEVATION

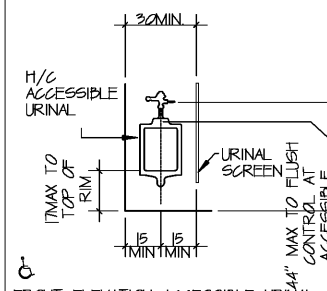

FRONT ELEVATION ACCESSIBLE URINAL STALL

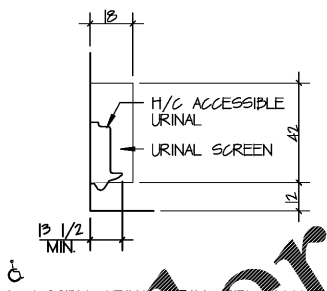

ACCESSIBLE URINAL - WALL SIDE ELEVATION

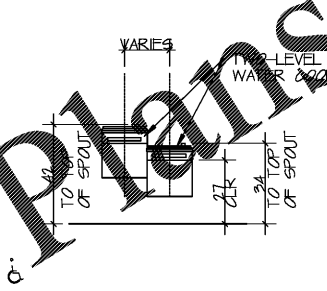

TWO-LEVEL WATER COOLER - HEIGHT FRONT ELEVATION

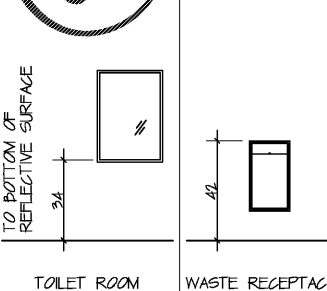

TOILET ROOM MIRROR

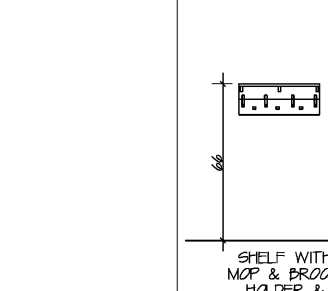

WASTE RECEPTACLES

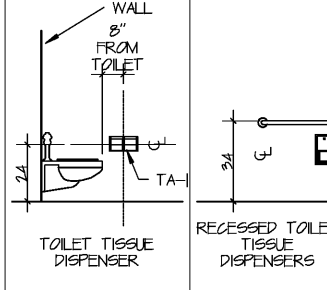

TOILET TISSUE DISPENSER

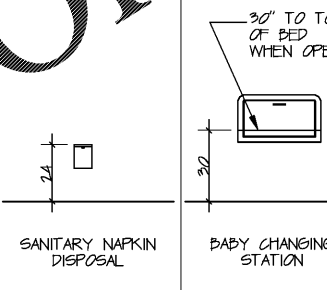

RECESSED TOILET TISSUE DISPENSERS

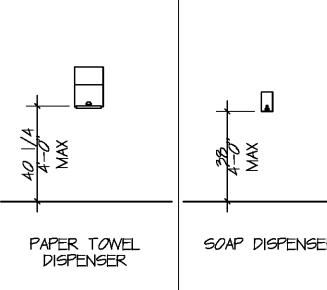

SANITARY NAPKIN DISPOSAL

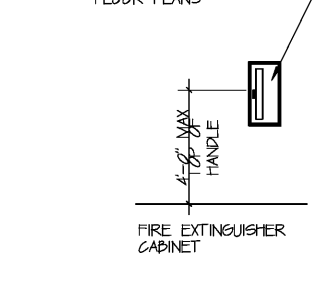

BABY CHANGING STATION

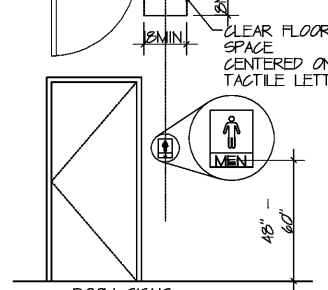

PAPER TOWEL DISPENSER



SOAP DISPENSER



FIRE EXTINGUISHER CABINET

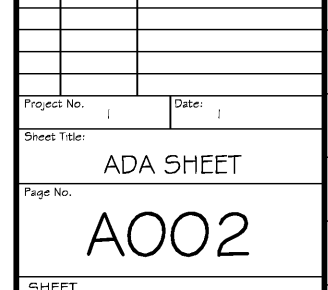

ROOM SIGNS

NOTE:
THIS IS A TYPICAL SIGNAGE, PLEASE FOLLOW FSEC STANDARD FOR THEIR TYPE SIGNAGE

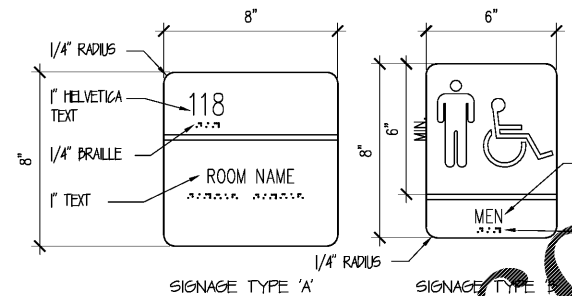

WHERE THERE IS NO WALL SPACE AT THE LATCH SIDE OF THE DOOR OR AT THE RIGHT SIDE OF DOUBLE DOORS, SIGNS SHALL BE LOCATED ON THE NEAREST ADJACENT WALL

NO.	DESCRIPTION	MPER	MSPEL	REMARKS
TA-01	41" GRAB BAR	DOBRLUK	D-3800WAL	
TA-02	36" GRAB BAR	DOBRLUK	D-3800WAL	
TA-03	NAPKIN DISPOSAL	DOBRLUK	D-310	
TA-04	RECESSED TOILET SEAT COVER DISPENSER	DOBRLUK	D-301	
TA-05	TOILET TISSUE DISPENSER	DOBRLUK	D-1288	OPEN
TA-06	SOAP DISP.	GEORGINA PACIFIC	I-AC04-1	OPEN
TA-07	WASTE RECEPTACLE	DOBRLUK	D-3444	
TA-08	FRAMED MIRROR	DOBRLUK	D-145	
TA-09	PAPER TOWEL DISPENSER SURFACE MNT.	GEORGINA PACIFIC	NOTION	OPEN
TA-10	BABY CHANGING STATION	DOBRLUK	KM02-0500A	
TA-11	MOP RACK W/ SHELF	DOBRLUK	D-130	

Order Plans

LEAN dental design

8000 IH-10, FRONTAGE RD., STE 300
SAN ANTONIO, TX 78230
210-899-4500

DENTAL OFFICES OF
DR. FREITAS & DR. SOUZA
DEMOLITION PACKAGE
17901 NW 5TH STREET, SUITE 202, PEMBROKE PINES, FL 33029

ISSUE		
NO.	DATE	DESCRIPTION
1	2/25/2020	FOR BID & CONSTRUCTION

Project No. _____ Date: _____
Sheet Title:
ADA SHEET
Page No.
A002
SHEET
4 OF 5