

**A. VINYL TO CONCRETE**  
FULL SIZE

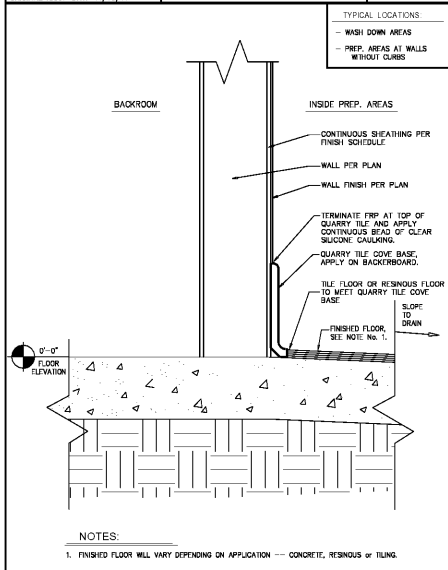

**B. RESINOUS TO FINISH FLOOR TRANSITION FOR REMODELS**  
HALF SIZE

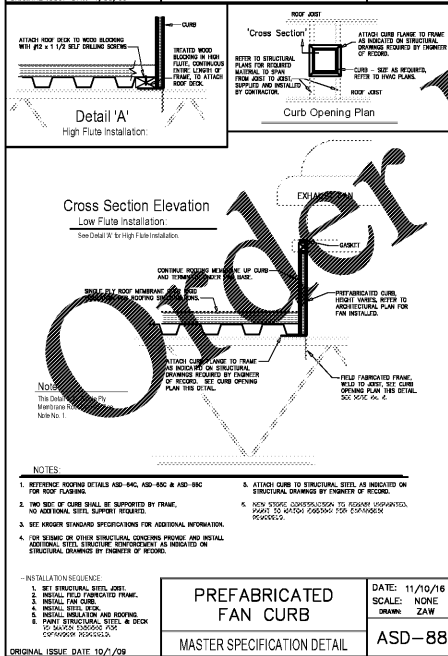

**WALL TO FLOOR BASE TYPE-C**  
MASTER SPECIFICATION DETAIL ASD-51C  
DATE: 8/22/18  
SCALE: NONE  
DRAWN: ZAW

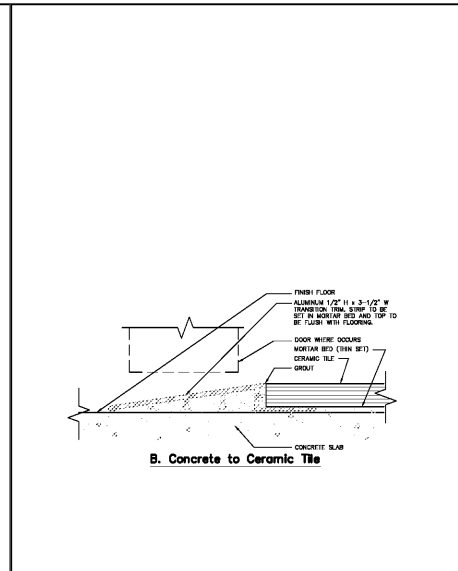

**A. CARPET TO VCT / LVT**

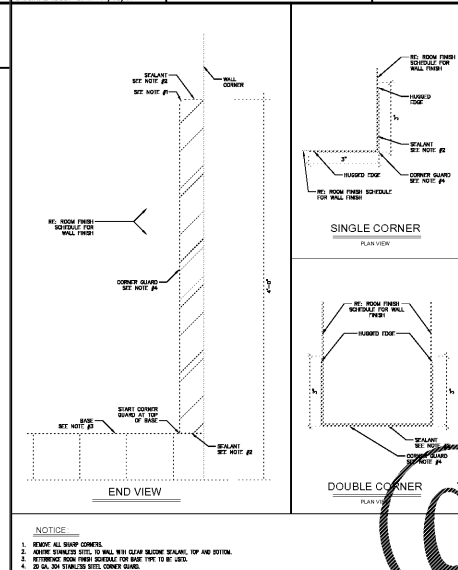

**B. CARPET TO CONCRETE / VINYL**

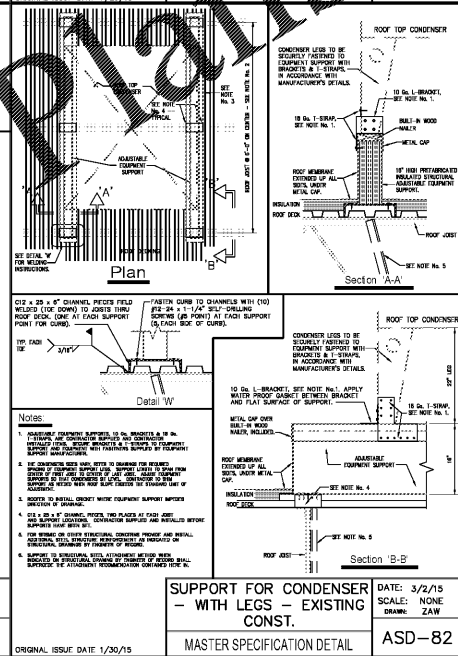

**STAINLESS STEEL CORNER**  
MASTER SPECIFICATION DETAIL ASD-55A  
DATE: 8/29/13  
SCALE: NONE  
DRAWN: TMH

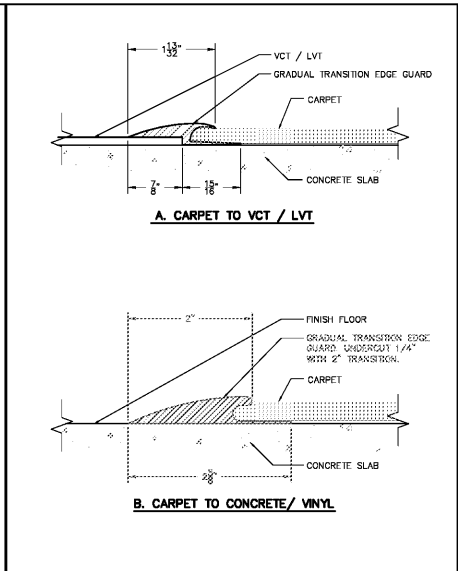

**REMOVABLE PROTECTIVE POST INSTALLATION**  
MASTER SPECIFICATION DETAIL ASD-19  
DATE: 5/24/18  
SCALE: NONE  
DRAWN: ZAW

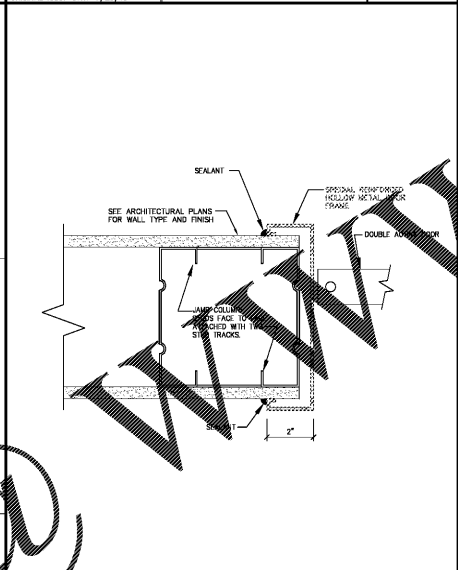

**CONCRETE FLOOR REPLACEMENT AT EXISTING SLAB**  
MASTER SPECIFICATION DETAIL ASD-69  
DATE: 11/10/11  
SCALE: NONE  
DRAWN: ZAW

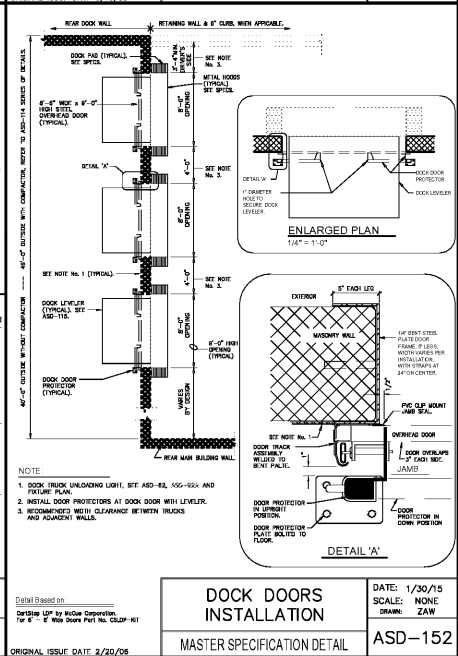

**DOCK DOORS INSTALLATION**  
MASTER SPECIFICATION DETAIL ASD-152  
DATE: 1/30/15  
SCALE: NONE  
DRAWN: ZAW

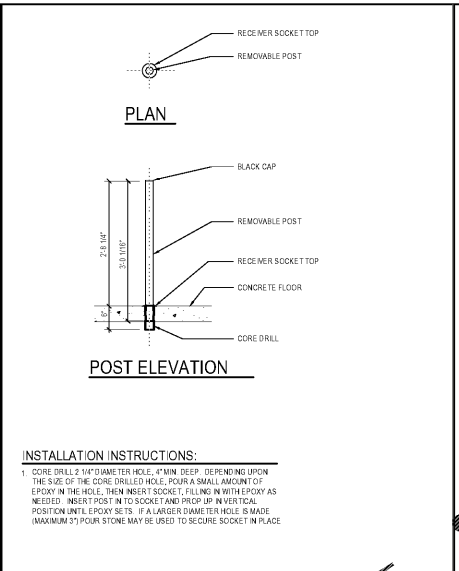

**WALL TO FLOOR BASE TYPE-D**  
MASTER SPECIFICATION DETAIL ASD-51D  
DATE: 11/7/13  
SCALE: NONE  
DRAWN: ZAW

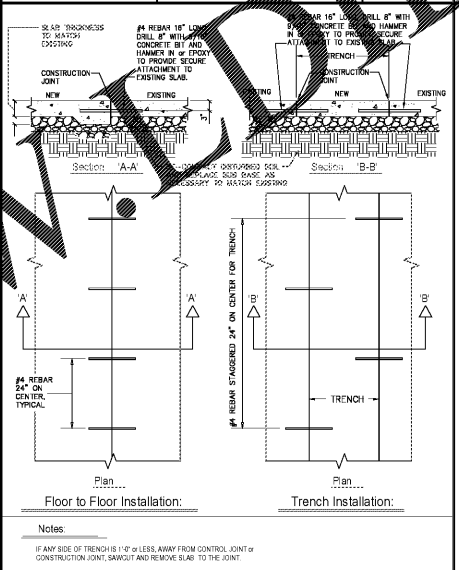

**DELI MONITOR MOUNTING (8FT. DROP PARTITION)**  
MASTER SPECIFICATION DETAIL ASD-72A  
DATE: 11/28/17  
SCALE: NONE  
DRAWN: TMH

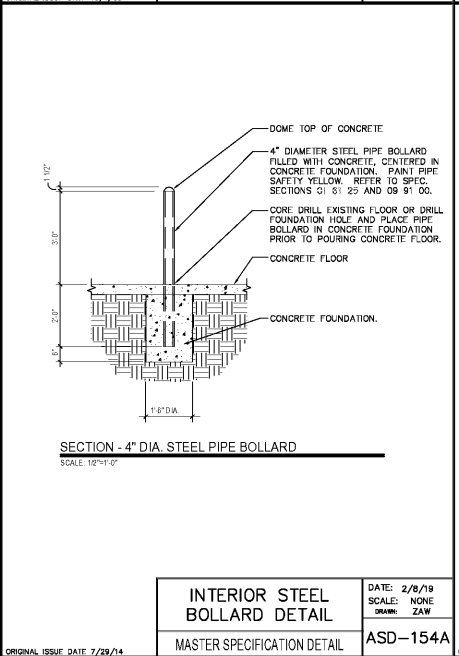

**CONCRETE PATTERN TYP. FOR POLISHED CONCRETE SALES AREA FLOORS**  
MASTER SPECIFICATION DETAIL ASD-156  
DATE: 11/21/14  
SCALE: NONE  
DRAWN: ZAW

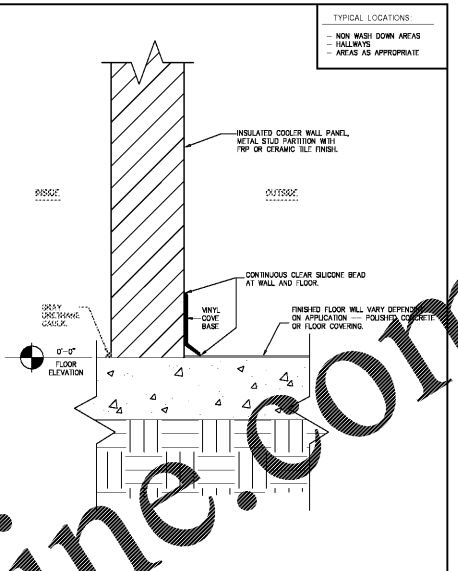

**PREFABRICATED FAN CURB**  
MASTER SPECIFICATION DETAIL ASD-88  
DATE: 11/10/16  
SCALE: NONE  
DRAWN: ZAW

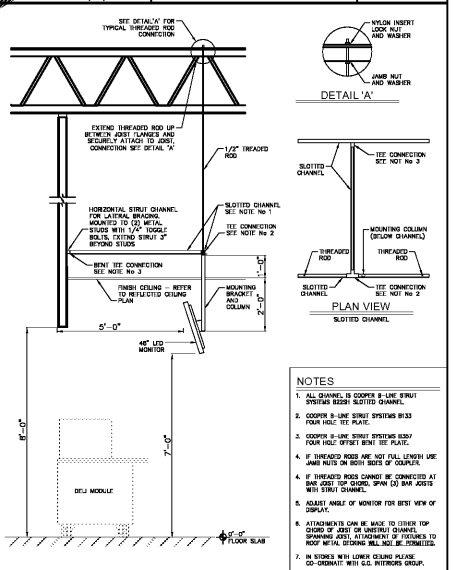

**SUPPORT FOR CONDENSER WITH LEGS - EXISTING CONST.**  
MASTER SPECIFICATION DETAIL ASD-82  
DATE: 3/2/15  
SCALE: NONE  
DRAWN: ZAW

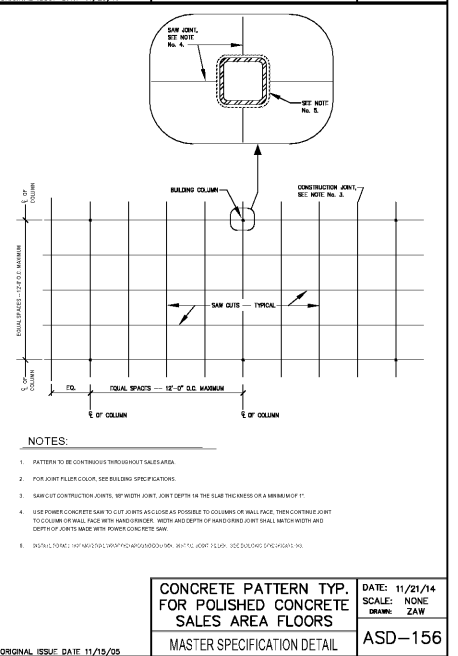

**INTERIOR STEEL BOLLARD DETAIL**  
MASTER SPECIFICATION DETAIL ASD-154A  
DATE: 2/9/19  
SCALE: NONE  
DRAWN: ZAW

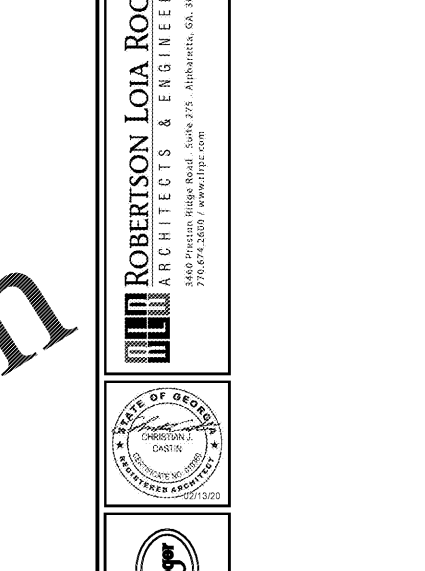

**DOUBLE ACTING DOOR FRAME AT STUD PARTITION**  
MASTER SPECIFICATION DETAIL ASD-56  
DATE: 8/7/13  
SCALE: NONE  
DRAWN: ZAW

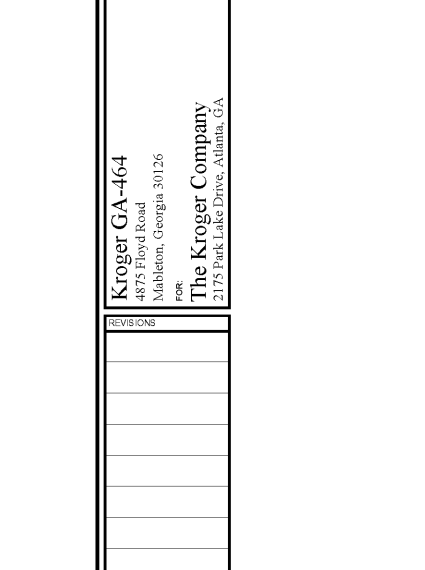

**ENLARGED PLAN**  
DETAIL 'A'

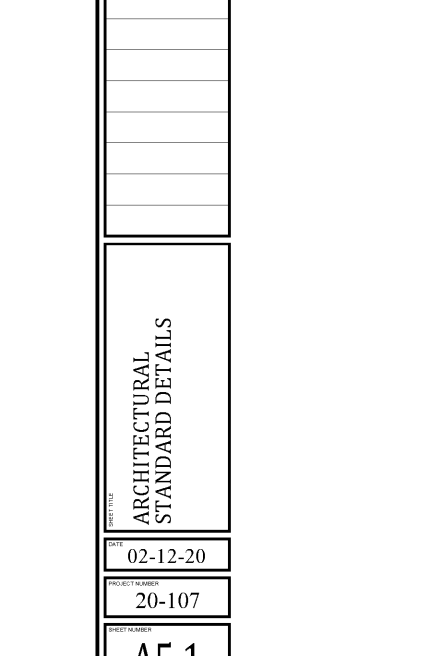

**ARCHITECTURAL STANDARD DETAILS**