

File: P:\25236.00 Hyundai of S. Charlotte (DWG)\CD\AS-Series_PlanSet_3/5/2020 11:10 AM by CHRIS_Somer_3/5/2020 10:03 PM by CHRIS
 Sheet Template ID: CPFL-07-01

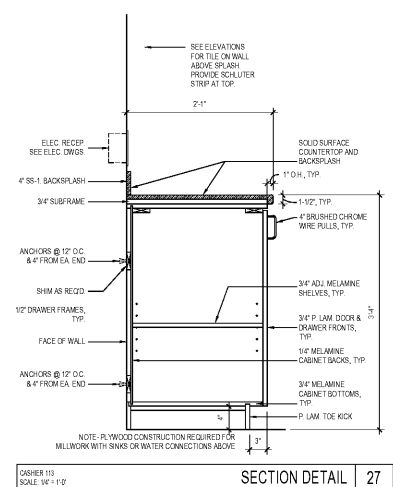

SECTION 27

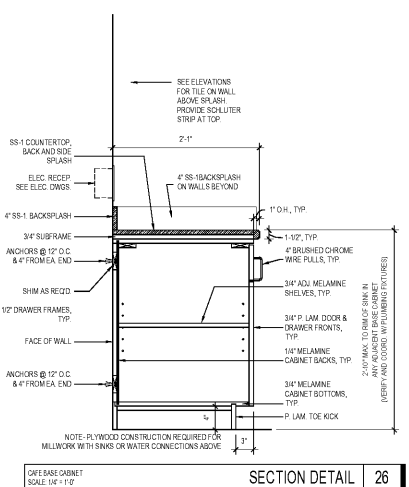

SECTION 26

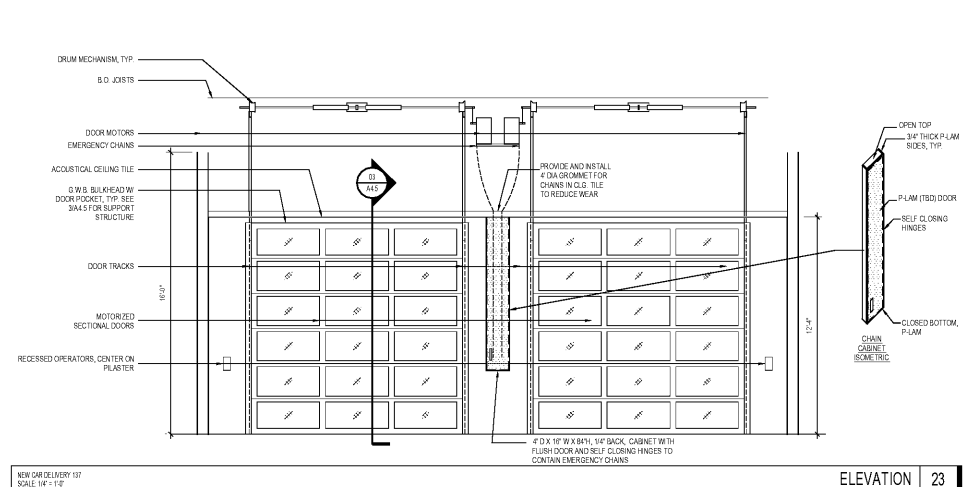

ELEVATION 23

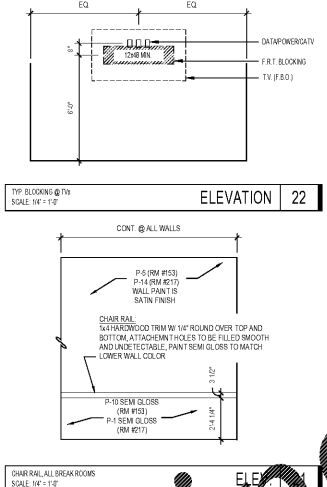

ELEVATION 22

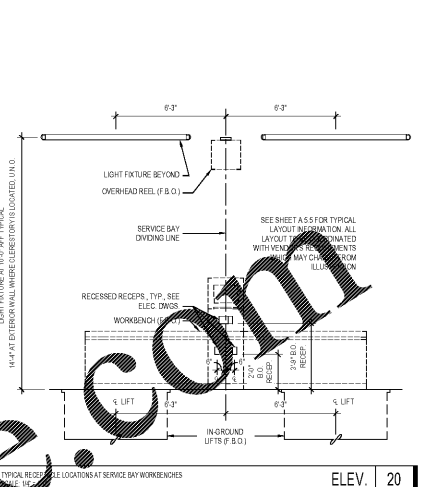

ELEV. 20

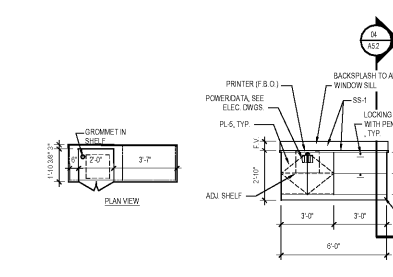

ELEVATION 25

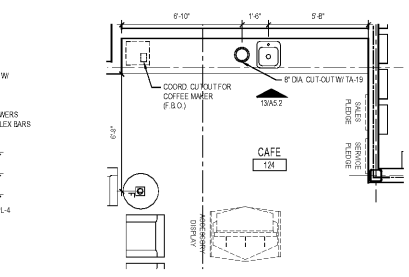

ENLARGED PLAN 24

G.C. PROVIDED & INSTALLED APPLIANCES	
SYMBOL	DESCRIPTION
[Symbol]	UNDERCOUNTER REFRIGERATOR & WAREWASH
[Symbol]	BUILT IN MICROWAVE - GE JAMS9185SS
[Symbol]	REFRIGERATOR - GE DEB30GSSS (BREAK TR)
[Symbol]	DISHWASHER - BOSCH SHX3AS2
[Symbol]	COUNTERTOP REFRIGERATOR BY OWNER
[Symbol]	REFRIGERATOR - WAREWASH (KES125SCH) BREAK TR
[Symbol]	DISPOSAL - SEE PLUMBING

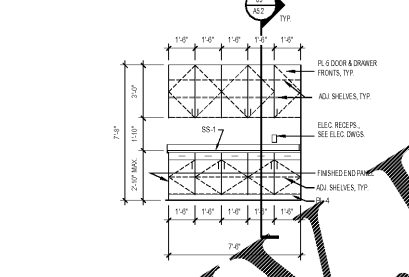

ELEVATION 19

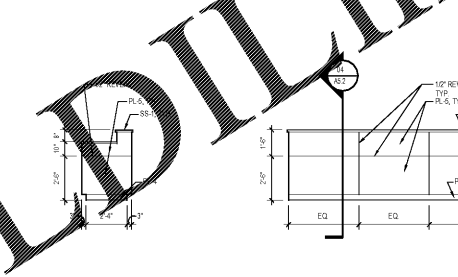

ELEV. 18

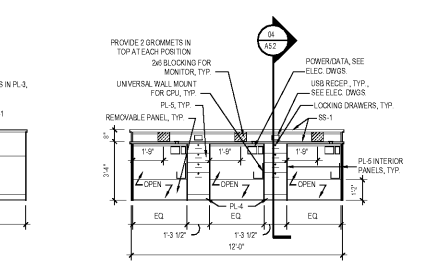

ELEVATION 17

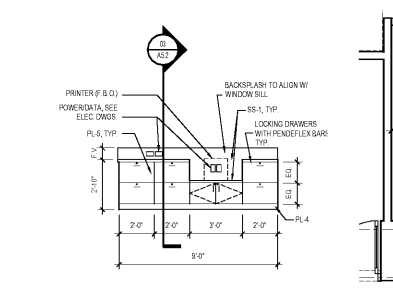

ELEVATION 15

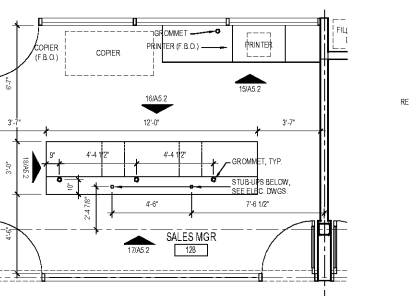

ENLARGED PLAN 14

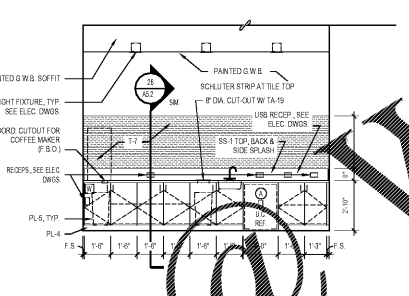

ELEVATION 13

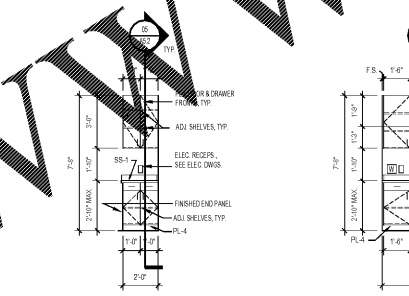

ELEVATION 12

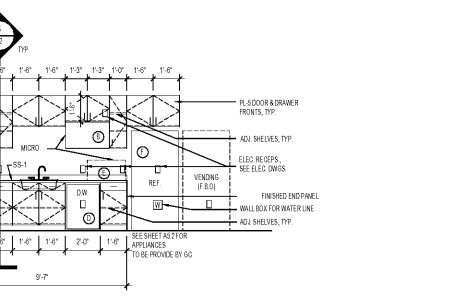

ELEV. 11

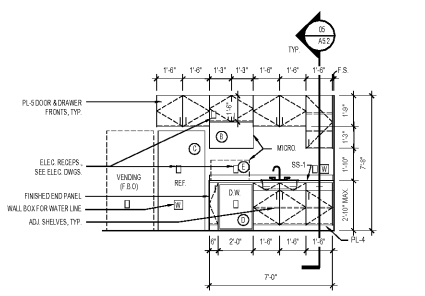

ELEVATION 10



ELEVATION 09

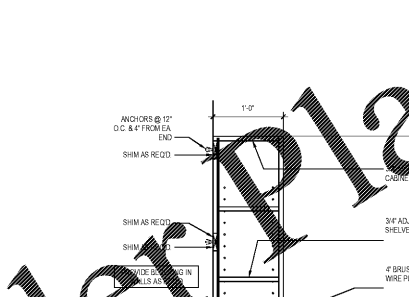

SECTION 05



SECTION 04

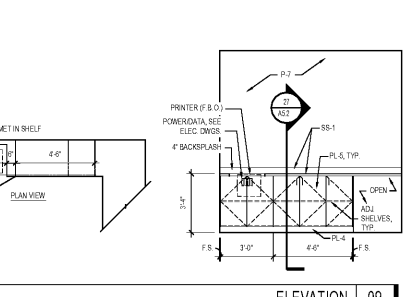

SECTION 03

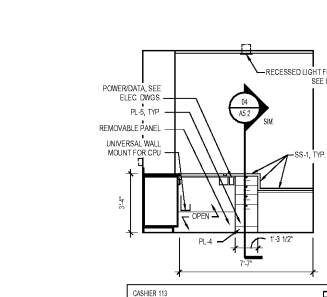

ELEV. 07

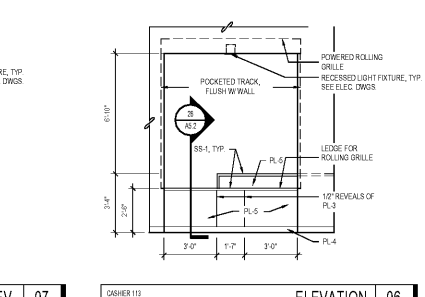

ELEVATION 06

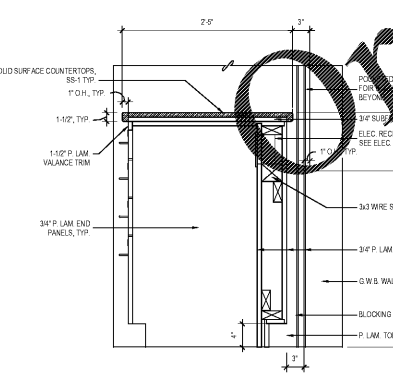

SECTION 26

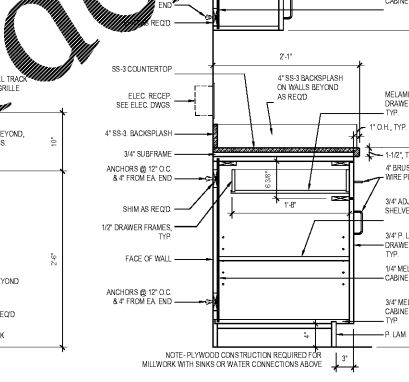

SECTION 05

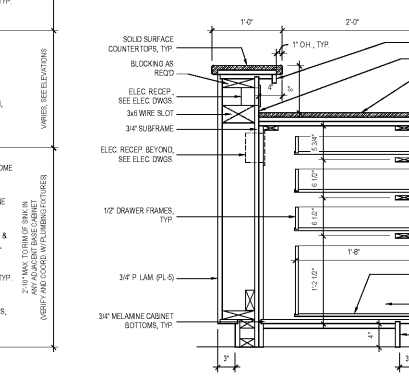

SECTION 04

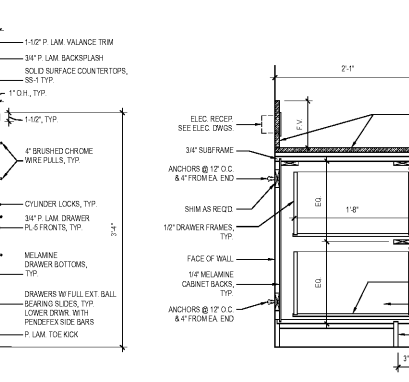

SECTION 03

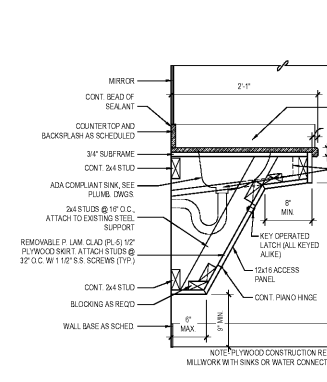

SECTION 02

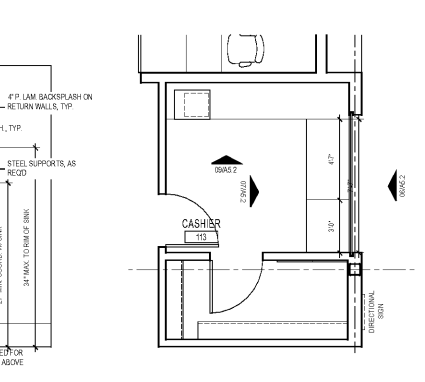

PLAN 01

THE OWNERS & WRITER HEREBY
 CONFIRM THAT THE ORIGINAL WORK OF THE ARCHITECT
 AS AN INTELLECTUAL PROPERTY & INSTRUMENT OF
 SERVICE ARE BEING LOANED TO THE CONTRACTOR FOR
 CONSTRUCTION OF THE PROJECT. REPRODUCTION
 OR USE IN ANY MANNER WITHOUT EXPRESS WRITTEN
 CONSENT OF THE ARCHITECT
 IS PROHIBITED.



North Carolina
 PROFESSIONAL ENGINEER
 License No. 83309
 RICHARD CLEBS
 ARCHITECT
 Seal: 03/04/2020

Project Title:
HYUNDAI SOUTH CHARLOTTE
 10518 CADILLAC STREET
 PINEVILLE, NC 28134
 Project No.: 25236.00
 Drawing Title:
**ENLARGED PLANS,
 INTERIOR ELEVATIONS
 & DETAILS**
 SET ISSUE DATE
 MARCH 4, 2020

Revisions:
 Number Date Description

Order Plans @ **WWW.LDILine.com**



Project Title:
HYUNDAI SOUTH CHARLOTTE
 10518 CADILLAC STREET
 PINEVILLE, NC 28134
 Project No.: 25236.00
 Drawing Title:
**ENLARGED PLANS,
 INTERIOR ELEVATIONS
 & DETAILS**
 SET ISSUE DATE
 MARCH 4, 2020

Revisions:
 Number Date Description

Project Title:
HYUNDAI SOUTH CHARLOTTE
 10518 CADILLAC STREET
 PINEVILLE, NC 28134
 Project No.: 25236.00
 Drawing Title:
**ENLARGED PLANS,
 INTERIOR ELEVATIONS
 & DETAILS**
 SET ISSUE DATE
 MARCH 4, 2020

Revisions:
 Number Date Description

Sheet
A5.2