



DUNWODY/BEELAND,
architects, inc.

Web: www.dunwoodybeeland.com
Macon, Georgia 31201
F 778-743-5863

Dunwoody/Beeland, Architects, Inc.
This drawing may be utilized only for the purpose of constructing or installing the work shown thereon at the site of the work specified. Any other use of this drawing, including without limitation any reproduction or alteration of this drawing, without prior written approval of Dunwoody/Beeland, Architects, Inc. is prohibited.

**A NEW RANGER STATION
AT CLAYSTONE PARK
FOR MACON-BIBB COUNTY**
MOSLEY DIXON ROAD MACON, GEORGIA

| Revisions: | |
|------------|--|
| | |
| | |
| | |

Sheet Title:
New Gatehouse:
Plan, Exterior Elevations
& Interior Elevations

Project #: 1819 Date: 12/20/19

A2.3

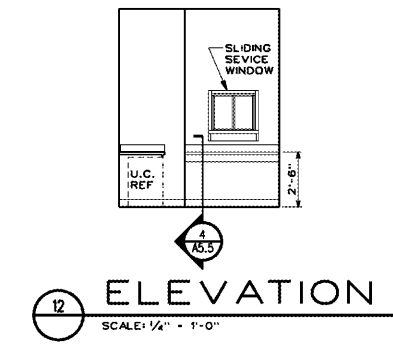
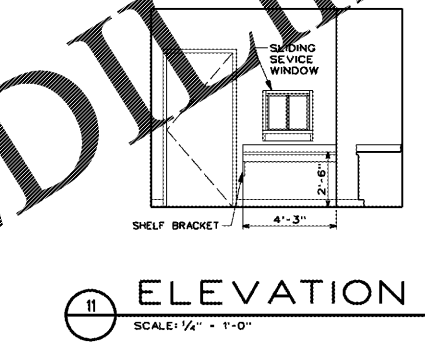
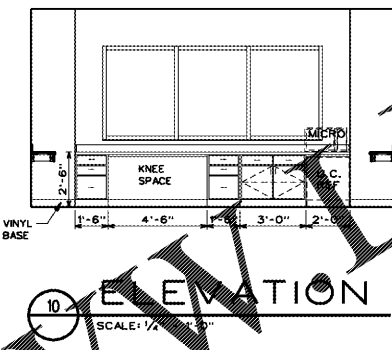
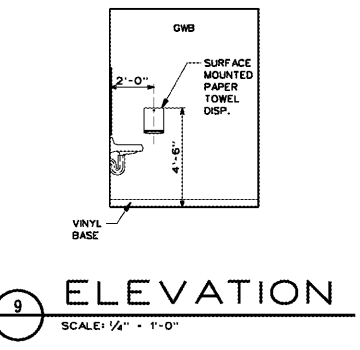
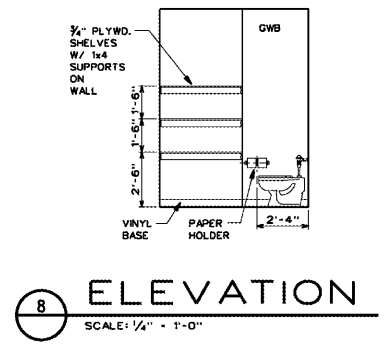
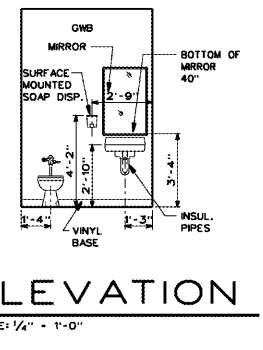
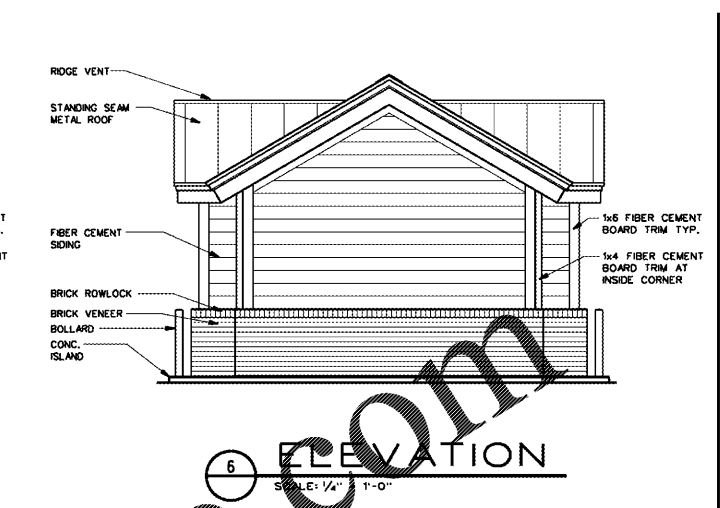
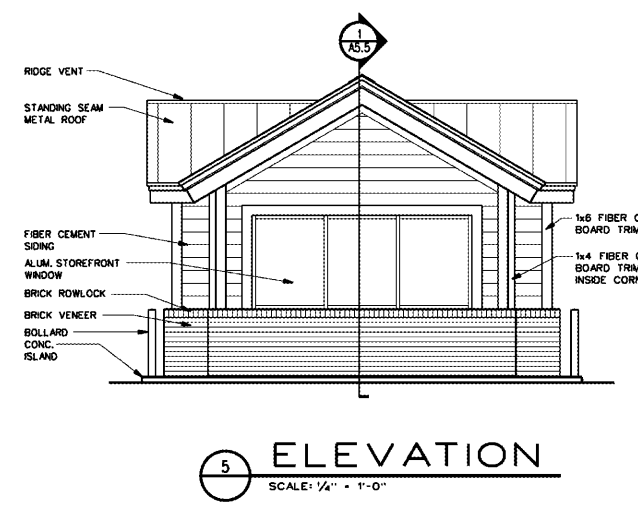
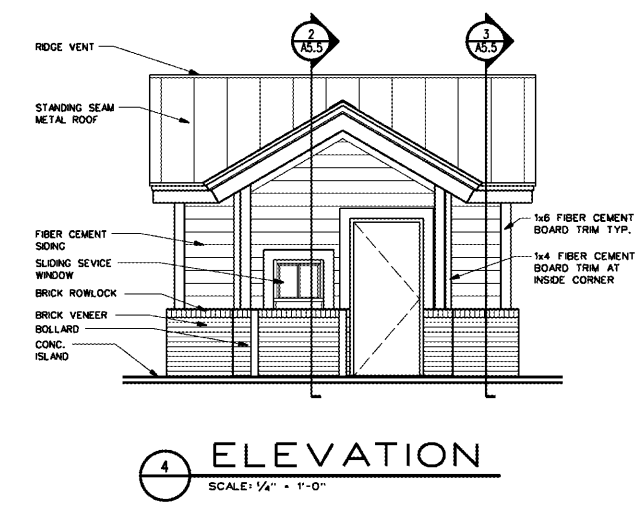
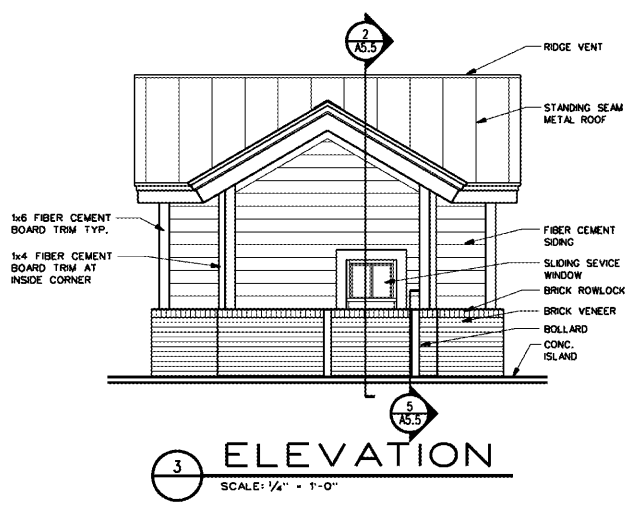

Order Plans @

