

8 WALL CLEANOUT DETAIL
SCALE: NONE

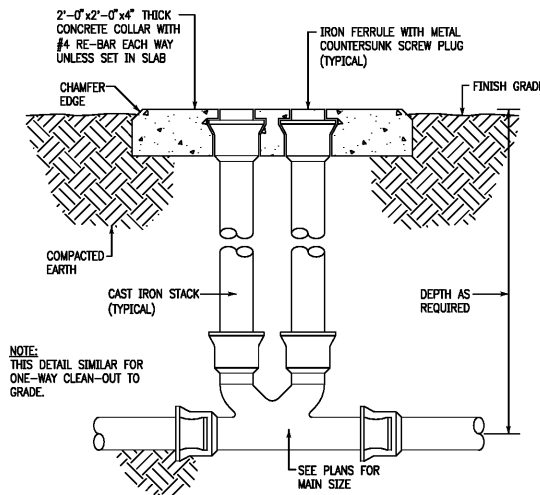

5 TWO WAY CLEANOUT DETAIL
SCALE: NONE

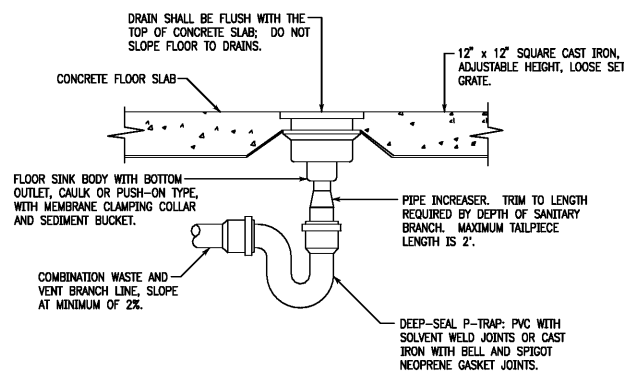

7 FLOOR SINK DETAIL
SCALE: NONE

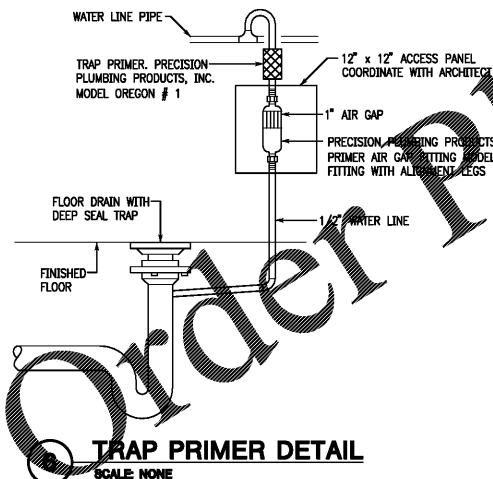

TRAP PRIMER DETAIL
SCALE: NONE

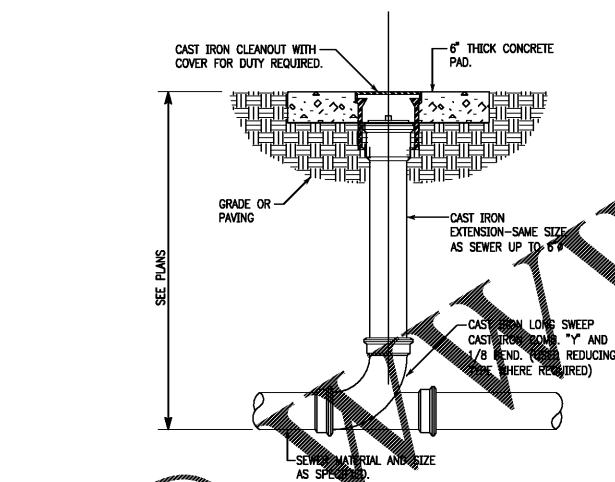

4 GROUND CLEANOUT (GCO) DETAIL
SCALE: NONE

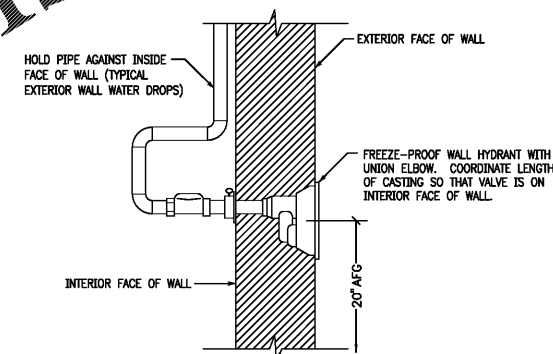

3 WALL HYDRANT DETAIL
SCALE: NONE

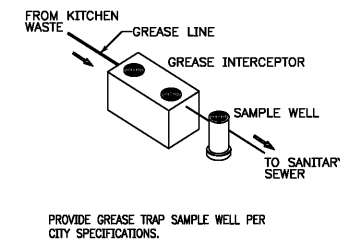

2 SAMPLE WELL DETAIL
SCALE: NONE

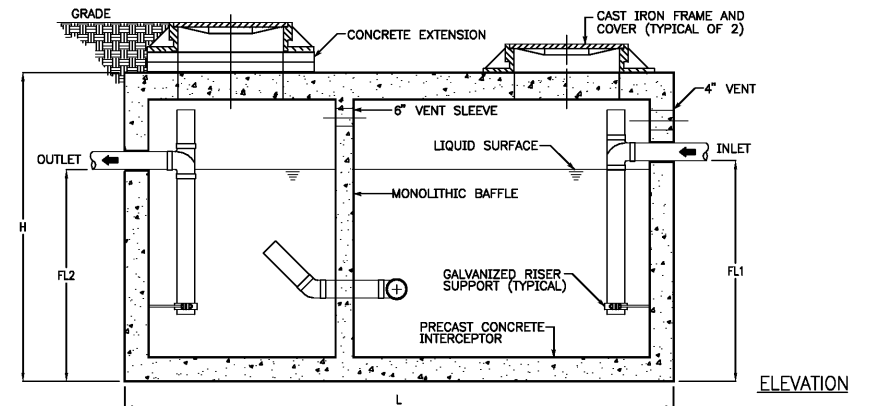
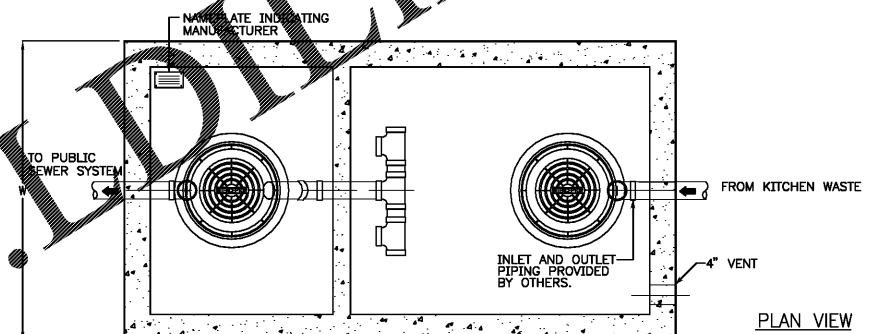

MODEL NO. PARK	CAPACITY USGal	GREASE CAP. (LBS)	EMPTY WT (LBS)	LENGTH L	WIDTH W	HEIGHT H	INLET FL1	OUTLET FL2
GT-500	500	1,200	7,000	7'-10"	4'-4"	4'-6"	3'-3"	3'-0"
GT-750	750	1,700	11,000	7'-10"	4'-4"	6'-0"	4'-5"	4'-2"
GT-1000	1,000	2,300	13,200	8'-8"	5'-0"	6'-0"	4'-9"	4'-6"
GT-1250	1,250	2,900	15,500	9'-2"	5'-8"	6'-0"	4'-9"	4'-6"
GT-1500	1,500	3,500	18,000	9'-2"	5'-8"	7'-0"	5'-9"	5'-6"
GT-2000	2,000	4,800	24,500	9'-0"	6'-0"	8'-0"	6'-9"	6'-6"
GT-2500	2,500	5,700	27,500	13'-0"	7'-0"	7'-0"	5'-9"	5'-6"
GT-3000	3,000	6,900	30,000	13'-0"	7'-0"	8'-0"	6'-9"	6'-6"
GT-3500	3,500	8,000	31,000	13'-0"	7'-0"	8'-6"	7'-3"	7'-0"
GT-4000	4,000	9,300	39,000	18'-0"	8'-6"	7'-0"	5'-9"	5'-6"

OTHER SIZES ARE AVAILABLE. CONTACT FOR MORE INFORMATION

1 GREASE INTERCEPTOR DETAIL
SCALE: NONE

- NOTES:
1. PROVIDE GREASE INTERCEPTOR SAMPLE WELL AND SECURING DEVICE PER CITY SPECIFICATIONS. SECURING DEVICE SHALL BE INSTALLED WITHIN TWO FEET OF THE SAMPLE WELL. THE SAMPLING WELL MUST BE INSTALLED IN A LOCATION THAT WILL NOT ALLOW IT TO BE OBSTRUCTED BY TRAFFIC, VEHICLES, DUMPSTERS, EQUIPMENT, ETC... AT ANY TIME.
 2. GREASE INTERCEPTOR SHALL CONFORM TO CITY SPECIFICATIONS.
 3. PROVIDE TRAFFIC RATED COVERS AS REQUIRED.

Gregory C. Speer
5020 Tennyson Pkwy. - Plano, TX 75024
Phone (214) 432-3030 / Fax (214) 618-8191

CONTRACTOR SHALL COORDINATE MEP DRAWINGS WITH ALL OTHER DISCIPLINES



John Franz Architect
ARCHITECTURE-INTERIOR ARCHITECTURE-PLANNING (817) 737-8678
605 INTERNATIONAL PLAZA, SUITE 100, FORT WORTH, TEXAS 76109

SHELL BUILDING
1855 CEDAR CREEK ROAD
FAYETTEVILLE, NORTH CAROLINA 28312

Revisions:

File Name: 19086
Project No: 19086
Date: 10/11/19
Drawn By:
Checked By:

SHEET
P302
PLUMBING
DETAILS

Order Plans @ www.LDOnline.com

AOS JOB #: 2568-009-19