

# Order Plans

# WWW.LDILine.com

**COOPER CARUSI COLLINS**  
ARCHITECTS

3391 Peachtree Rd NE, Suite 400  
Atlanta, Georgia 30326  
404-873-0001

LP Indoor Pavilion, LLC  
Managed by LakePoint Land, LLC

755 Highway 293  
Emerson, GA 30137



RENOVATIONS TO  
LAKEPOINT SPORTS  
PAVILION  
MEZZANINE  
755 Highway 293  
Emerson, GA 30137

PROJECT NUMBER  
19018.00



THIS DRAWING IS THE EXCLUSIVE PROPERTY OF THE ARCHITECTS AND MAY NOT BE REPRODUCED OR USED WITHOUT THEIR WRITTEN AUTHORIZATION AND PERMISSION.

COPYRIGHT © 2017 COLLINS COOPER ARCHITECTS, INC.

RELEASED FOR  
CONSTRUCTION

PERMIT DOCUMENTS 12.18.19

ISSUED FOR BID 01.15.20

NOTE: READ THE SPECIFICATIONS  
THIS SET OF DRAWINGS AND SPECIFICATIONS DEFINE  
PROJECT SCOPE AND CONFORMANCE REQUIREMENTS.  
INDIVIDUAL SHEETS SEPARATED FROM THE SET MAY NOT  
NECESSARILY REFLECT ALL INFORMATION NEEDED TO  
SUITABLY COVER CERTAIN ITEMS. DO NOT SEPARATE  
THIS SET OF DRAWINGS INTO INDIVIDUAL SHEETS.

SHEET TITLE  
ENLARGED TOILET PLANS,  
ELEVATIONS & EQUIPMENT  
SCHEDULE

## A-402

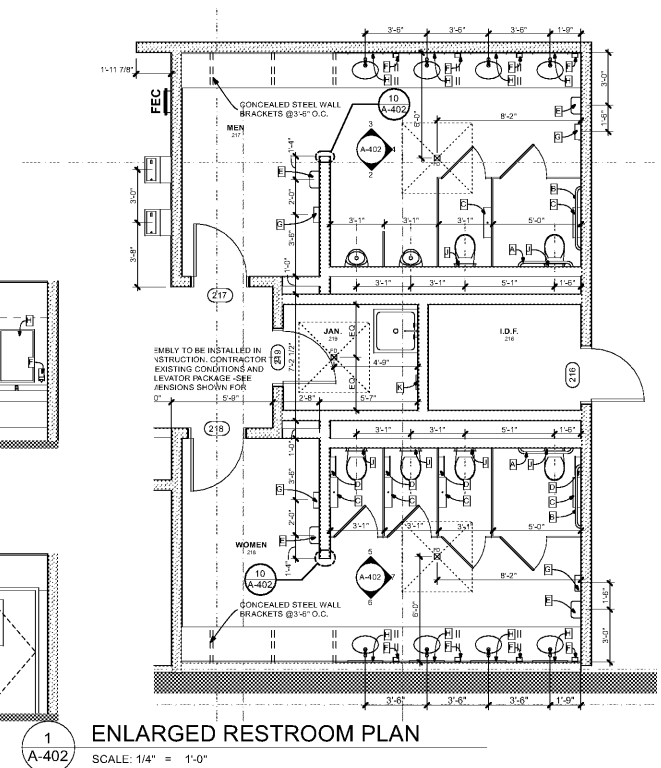
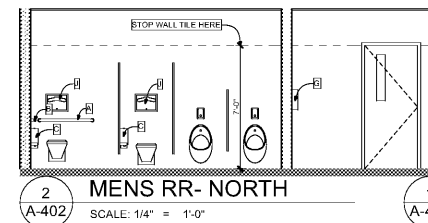
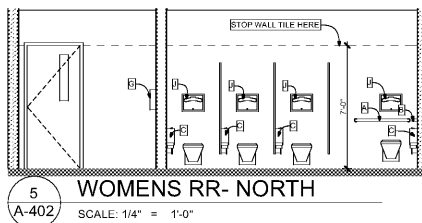
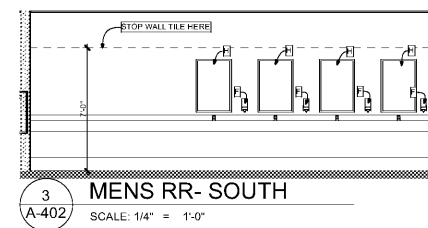
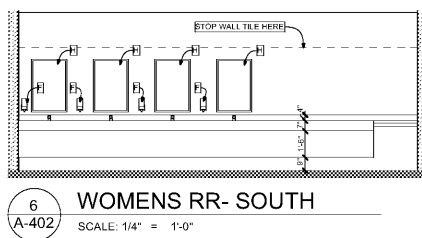
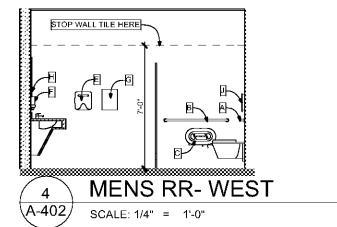
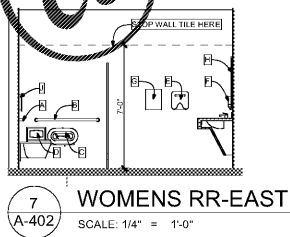
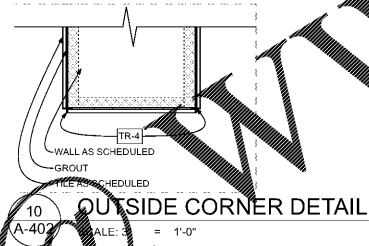
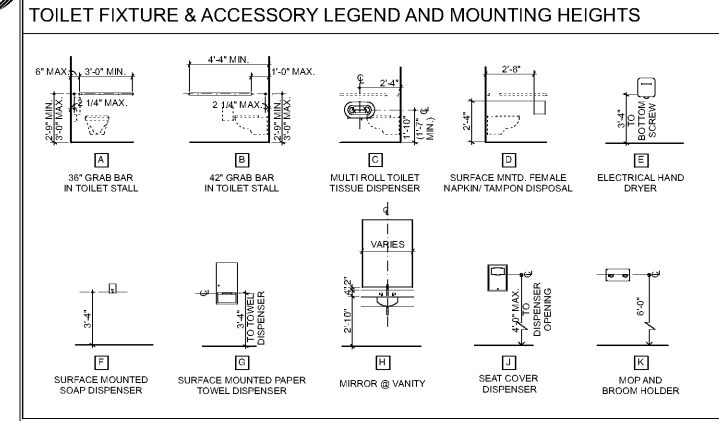

BIM Server: s:\instruments\com\lin - bim\server - 2017\projects\2019\LDI\102019 LakePoint Charleston Cooper Mezzanine - 121021