

ACCESSIBLE EWC
NO SCALE

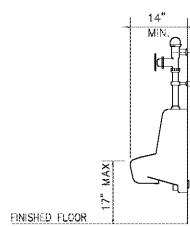

ACCESSIBLE URINAL
NO SCALE

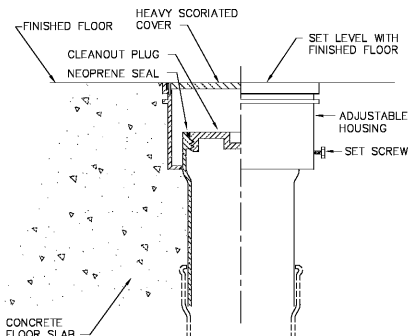

FLOOR CLEANOUT DETAIL
NO SCALE

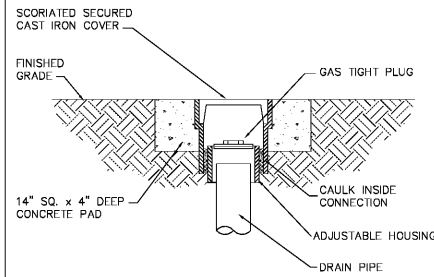

GRADE CLEANOUT
NO SCALE

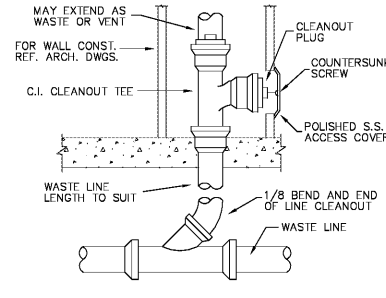

WALL CLEANOUT DETAIL
NO SCALE

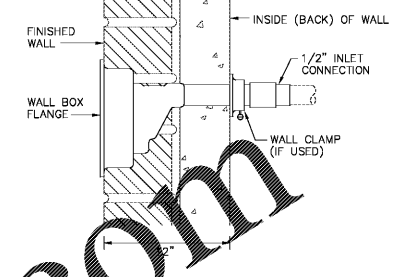

FREEZE-PROOF WALL HYDRANT
NO SCALE

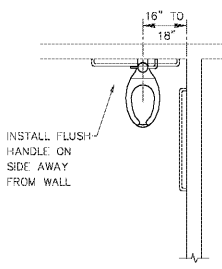

ACCESSIBLE WATERCLOSET
NO SCALE

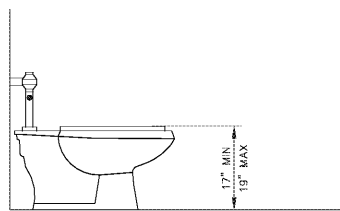

ACCESSIBLE WATERCLOSET
NO SCALE

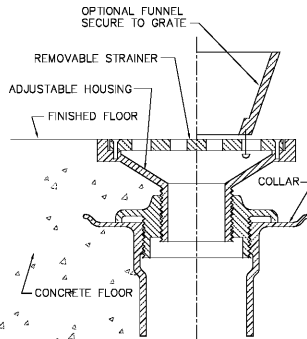

FLOOR DRAIN DETAIL
NO SCALE

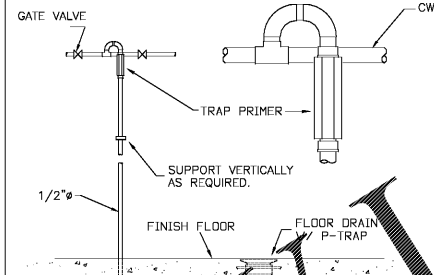

TRAP PRIMER DETAIL
NO SCALE

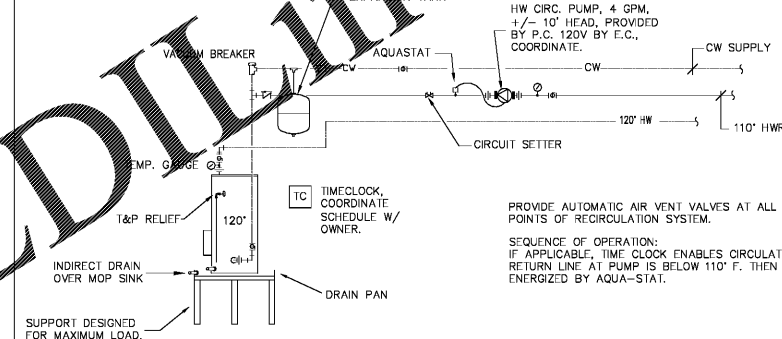

WATER HEATER SCHEMATIC
NO SCALE

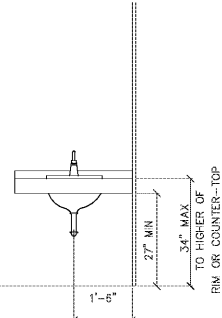

ACCESSIBLE SINK/LAV
NO SCALE

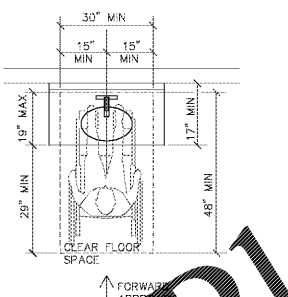

ACCESSIBLE SINK/LAV
NO SCALE

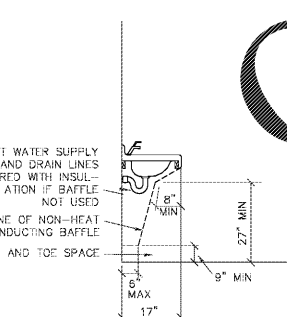

ACCESSIBLE SINK/LAV
NO SCALE

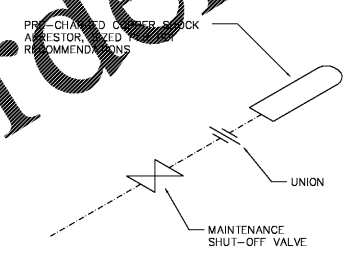

WATER HAMMER ARRESTOR
NO SCALE

FOR CONTINUATION TO SITE SANITARY SCHEDULE SEE CIVIL SITE PLAN BY OTHERS

DWV RISER DIAGRAM
NO SCALE

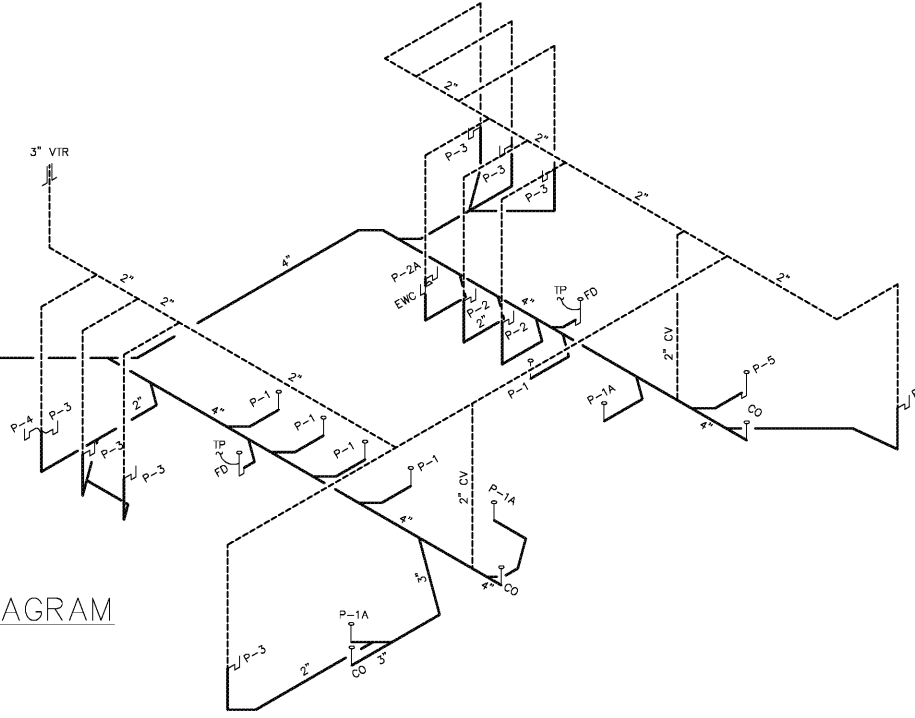

PLUMBING DETAILS
NO SCALE

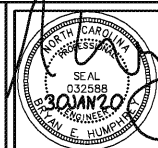

EUBANKS HUMPHREY
ENGINEERS ARCHITECTS
102 POLK ST., SUITE 200
GREENSBORO, NC 27401
Phone: 336.379.0663
Fax: 336.379.0653

NC FIRM LICENSE: C-2272



TEAGUIE
FREYALDENHOVEN
FREYALDENHOVEN
ARCHITECTS & PLANNERS, LLP

100 NORTH GREENE STREET
SUITE 101
GREENSBORO
NORTH CAROLINA 27401
TEL. 336.273.0101
FAX. 336.273.0141

CANTERBURY SCHOOL
P. DAVID BROWN LIBRARY AND
ADMINISTRATION BUILDING
5400 OLD LAKE JEANETTE RD
GREENSBORO, NORTH CAROLINA

DATE: 30JAN20
EHEPC PROJECT #: 1969

REVISIONS

SHEET

P-3

OF 3