

TEAGUE  
FREYALDENHOVEN  
FREYALDENHOVEN  
ARCHITECTS & PLANNERS, LLP

300 NORTH GREENE STREET  
SUITE 285  
GREENSBORO  
NORTH CAROLINA 27401  
TEL. 336.273.0101  
FAX. 336.273.0141

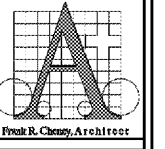

CANTERBURY SCHOOL  
P. DAVID BROWN BUILDING  
5400 OLD LAKE JEANETTE RD  
GREENSBORO, NORTH CAROLINA



DATE  
JAN 30, 2020  
PROJECT #  
19117  
FILE #  
19117-A3.3  
REVISIONS

THIS DRAWING IS AN INSTRUMENT OF PROFESSIONAL SERVICE PREPARED BY THE ARCHITECTS & PLANNERS, LLP (TTP), AND IS THE PROPERTY OF TTP. ALLOCATION OF THIS DOCUMENT BY ANY PARTY OTHER THAN TTP IS A VIOLATION OF LAW THAT WILL BE PROSECUTED TO ITS FULLEST EXTENT. THIS DRAWING SHALL NOT BE USED FOR ANY WORK OTHER THAN THAT AUTHORIZED BY THE ARCHITECT. IT IS NOT TO BE COPIED, REPRODUCED OR PART OF WHOLE.

SHEET

A3.3

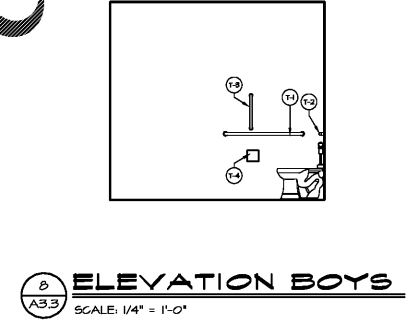
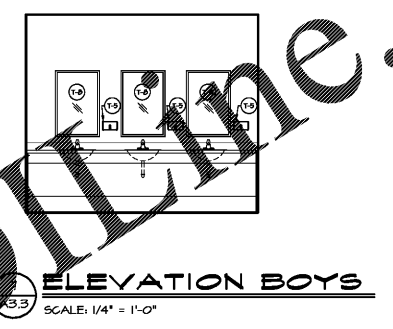
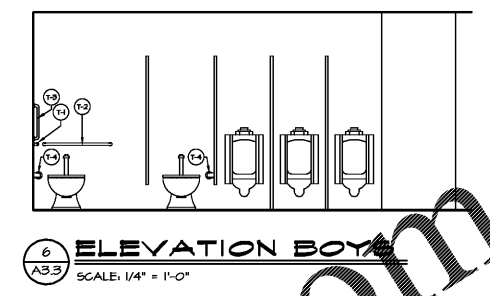
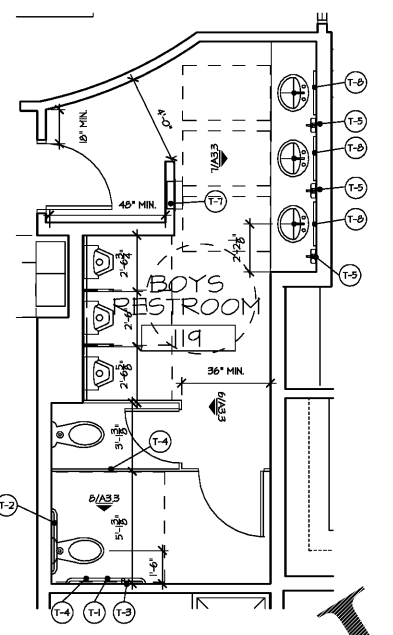
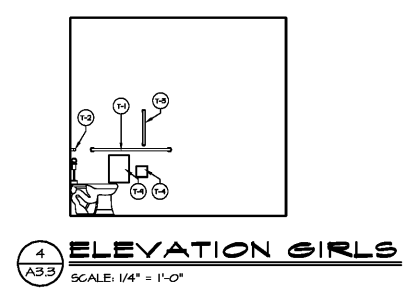
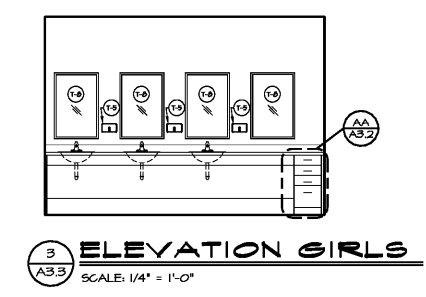
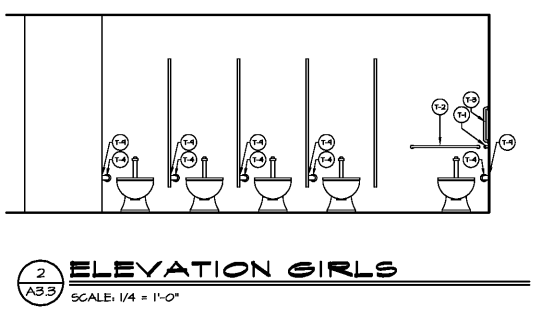
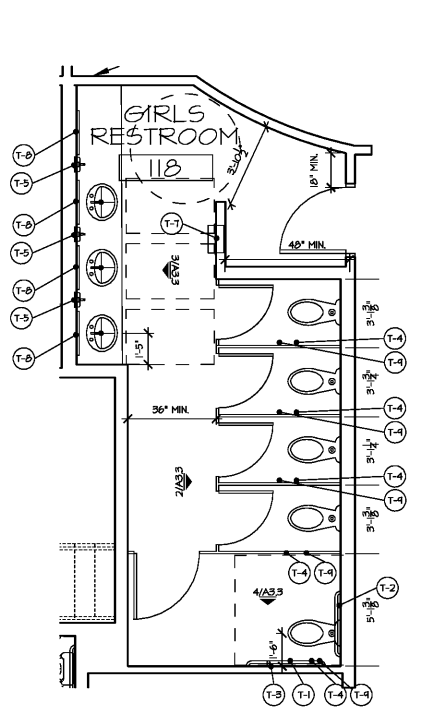

1 ENLARGED PLAN GIRLS  
A3.3 SCALE: 1/4" = 1'-0"

2 ELEVATION GIRLS  
A3.3 SCALE: 1/4" = 1'-0"

3 ELEVATION GIRLS  
A3.3 SCALE: 1/4" = 1'-0"

4 ELEVATION GIRLS  
A3.3 SCALE: 1/4" = 1'-0"

5 ENLARGED PLAN BOYS  
A3.3 SCALE: 1/4" = 1'-0"

6 ELEVATION BOYS  
A3.3 SCALE: 1/4" = 1'-0"

7 ELEVATION BOYS  
A3.3 SCALE: 1/4" = 1'-0"

8 ELEVATION BOYS  
A3.3 SCALE: 1/4" = 1'-0"

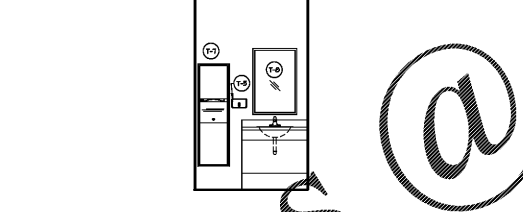
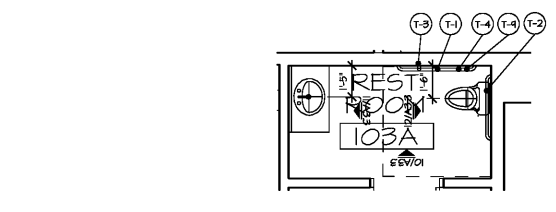

9 ENLARGED PLAN RESTROOM  
A3.3 SCALE: 1/4" = 1'-0"

11 RESTROOM ELEVATION  
A3.3 SCALE: 1/4" = 1'-0"

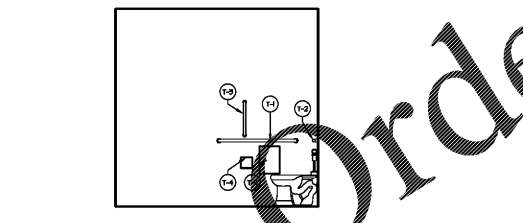

10 RESTROOM ELEVATION  
A3.3 SCALE: 1/4" = 1'-0"

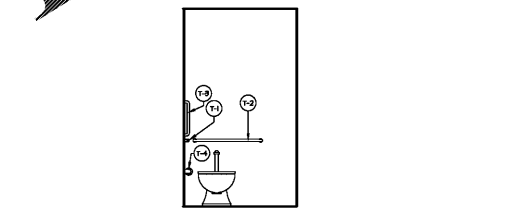

12 RESTROOM ELEVATION  
A3.3 SCALE: 1/4" = 1'-0"

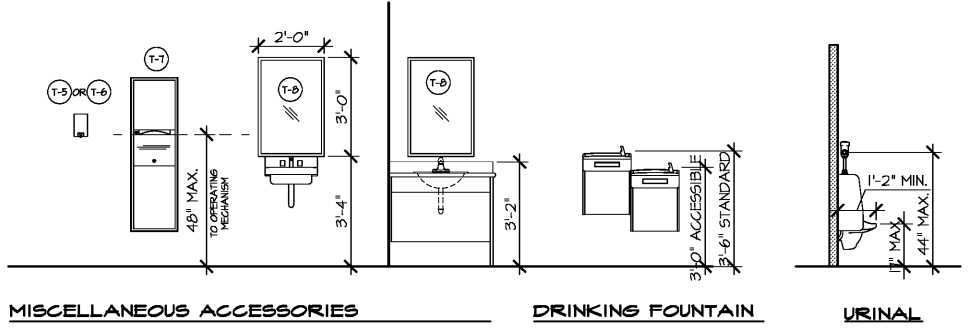
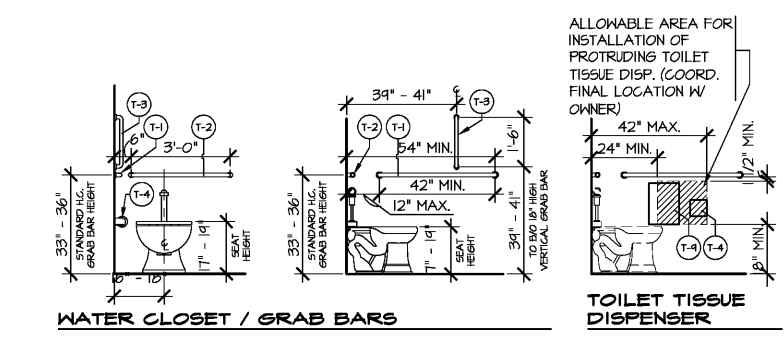
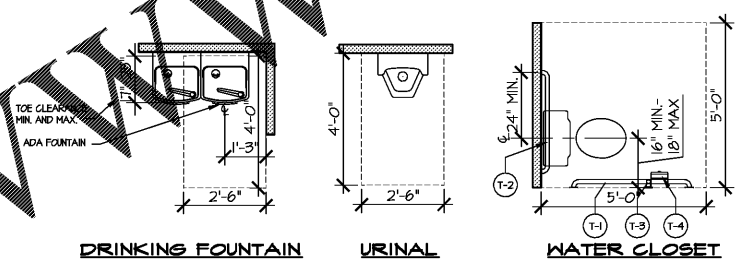

12 MOUNTING HEIGHTS  
A3.3 SCALE: 1/4" = 1'-0"

TOILET ACCESSORY LEGEND (NOT ALL MAY APPLY)

- T-1 42" SIDE HALL GRAB BAR (TOILET) SEE MOUNTING HEIGHTS. (12" FROM REAR WALL)
- T-2 36" REAR WALL GRAB BAR (TOILET) SEE MOUNTING HEIGHTS. (6" FROM SIDE WALL)
- T-3 18" VERTICAL GRAB BAR (TOILET) SEE MOUNTING HEIGHTS.
- T-4 TOILET TISSUE DISPENSER SEE MOUNTING HEIGHTS
- T-5 SURFACE MOUNTED SOAP DISPENSER SEE MOUNTING HEIGHTS (PROVIDE ONE AT EACH SINK/LAV)
- T-6 HAND SANITIZER DISPENSER SEE MOUNTING HEIGHTS (PROVIDE ONE AT EACH SINK/LAV)
- T-7 PAPER TOWEL DISPENSER SEE MOUNTING HEIGHTS
- T-8 FRAMED MIRROR 2'-0" X 3'-0" MOUNT 1/4" BOTTOM OF MIRROR @ 40" AFF. MAX
- T-9 SANITARY WASTE DISPOSAL SEE MOUNTING HEIGHTS

- ALL MOUNTING HEIGHTS SHOULD COMPLY WITH THE 2009 ICG/ANSI A117.1 AND THE MANUFACTURER'S RECOMMENDATIONS (WHERE APPLICABLE).
- IF NOT SPECIFICALLY NOTED ABOVE, SEE TOILET ACCESSORIES MOUNTING HEIGHTS DETAIL ON SHEET A3.3.
- PROVIDE FIRE-RETARDANT HOOD BLOCKING AS REQUIRED FOR ALL WALL-MOUNTED ACCESSORIES.
- GC TO CONFIRM FINAL APPROVAL OF TOILET ACCESSORY TYPES/MODELS WITH OWNER.

Order Plans @ WWW.LDILLME.COM