

Shane R. Hamilton P.E.
CONSULTING ENGINEER
912 W. Dr. Martin Luther King Jr Blvd
Tampa, FL 33603 (813) 251-6848

DRAWING INFORMATION		
DATE	DESCRIPTION	BY
01-13-20	FOR CONSTRUCTION	JW

5' 7" FRYER HOOD

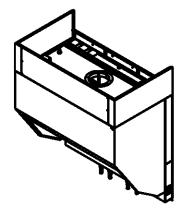

SHEET #	DESCRIPTION
01	COVER SHEET
02	FRONT ELEVATION
03	SECTION VIEW
04	PLAN VIEW
05	FIRE SUPPRESSION SYSTEM
06	FRONT ELEVATION - UTILITIES
07	UTILITIES PLAN VIEW
08	TYPICAL GAS APPLIANCE CONNECTION DETAILS
09	AMEREX PRE-PIPING DETAILS
10	COVER SHEET ENCLOSURE PANEL DETAILS
11	HOOD HANGING DETAILS
12	WALL FLASHING DETAILS
13	FAN SPECIFICATION
14	BROILER/OVEN HOOD EXHAUST FAN DUCT EXTENSION
15	BK HOOD EXHAUST FAN-FIRE SYSTEM-HVAC SYSTEM CONTROL MATRIX
16	RATING LABEL
18	WIRING DIAGRAM
19	CONTACT INFORMATION

DESCRIPTION
THE H&K INTERNATIONAL MODEL # 524N CANOPY STYLE VENTILATION HOOD IS INTENDED SPECIFICALLY FOR APPLICATIONS WHERE A BASKET FRYER CONFIGURATION ARE USED.

INSTALLATION
IT INCLUDES A 3" AIR SPACE 1" INSULATED BACK PANEL (CONTAINING 6\"/>

NOTE: INSTALLATION TO BE IN ACCORDANCE WITH ULC-5650, STANDARD FOR THE INSTALLATION AND PERFORMANCE OF VENTILATION AND FIRE SUPPRESSION FOR COMMERCIAL AND INSTITUTIONAL COOKING EQUIPMENT.

APPROVALS / CERTIFICATIONS
THIS HOOD COMPLIES WITH THE FOLLOWING:
UL746 / IULC-5646
STANDARD FOR EXHAUST HOOD AND RELATED CONTROLS FOR COMMERCIAL AND INSTITUTIONAL COOKING EQUIPMENT

NFPA 96
NATIONAL FIRE PROTECTION ASSOCIATION - STD 96
NFPA 96B
NATIONAL SANITATION FOUNDATION NO. 2 "HOOD SERVICE EQUIPMENT"

NOTE: THE EXHAUST AIR FLOW RATES WERE ESTABLISHED UNDER CONTROLLED LABORATORY CONDITIONS. GREATER EXHAUST RATES MAY BE REQUIRED FOR COMPLETE VAPOR AND SMOKE REMOVAL IN SPECIFIC INSTALLATIONS.

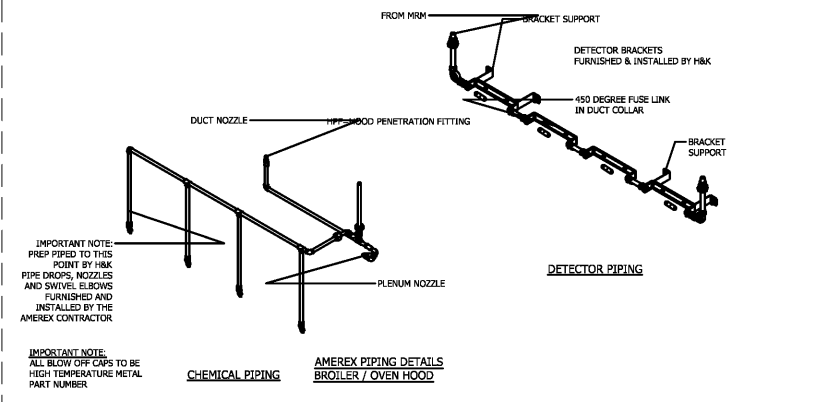
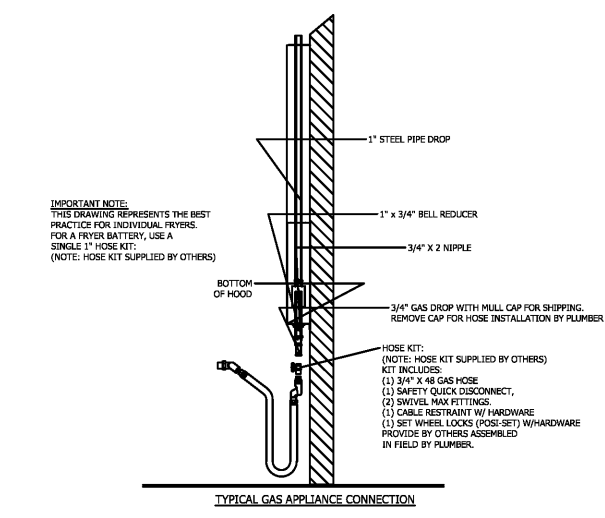
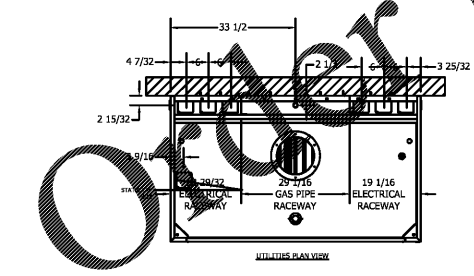
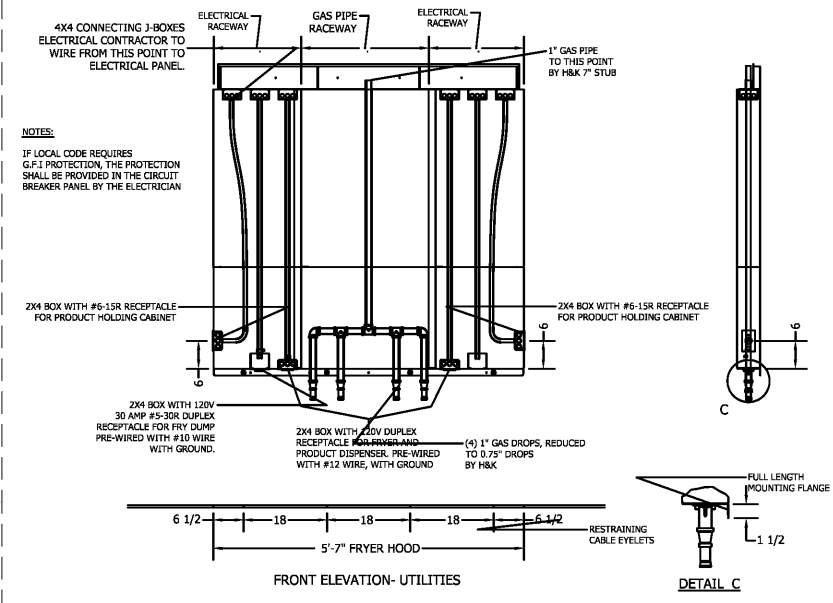
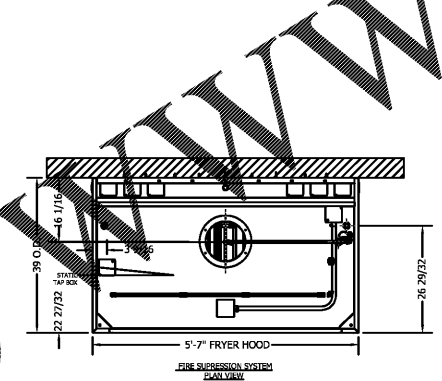
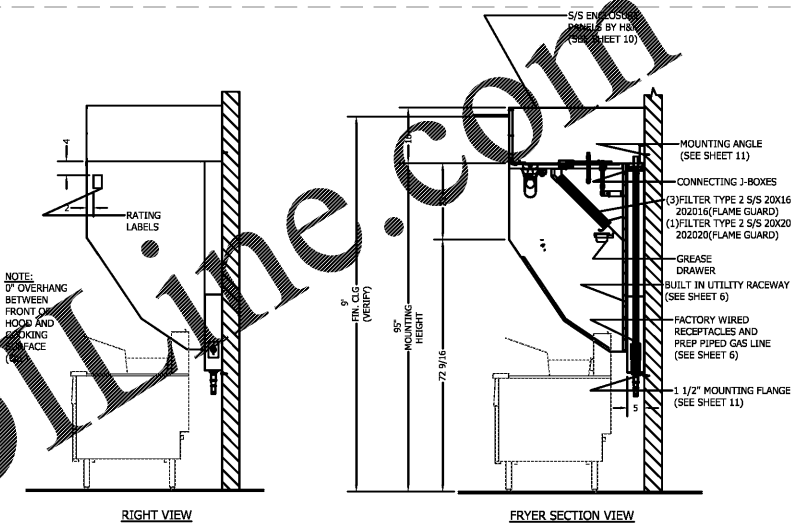
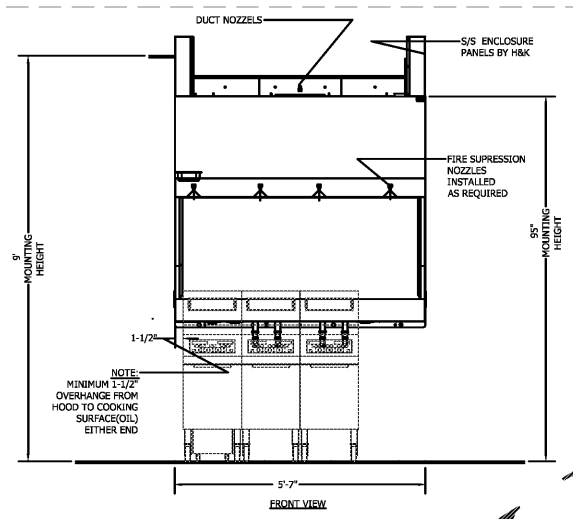
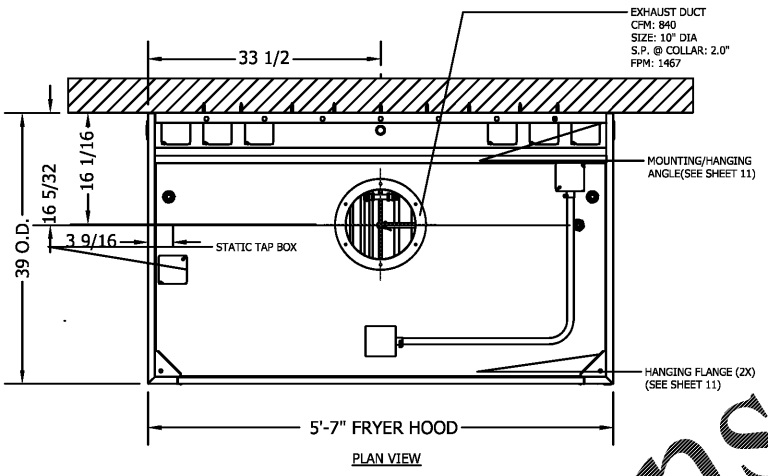

HVAC SYSTEM
N-C-A
CONSULTANTS / GROUP
6510 N. 125TH AVENUE, SUITE #1001
LARGO, FLORIDA
PHONE: (877) 530-0078
CALL NCA MARKETING FOR PRICING
NCA JOB# 20128

FRANCHISEE:
GPS HOSPITALITY
2100 RIVERDEDE PARKWAY
SUITE 850
ATLANTA, GA 30328
PHONE: 770-738-8798

CURRAN ARCHITECTURE
5719 LAWTON LOOP E. DR. #212
INDIANAPOLIS, IN 46216
O :: 317-288-0681
F :: 317-288-0753

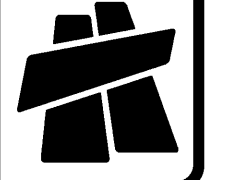

SHANE HAMILTON, P.E.
912 W. DR. MARTIN LUTHER KING JR. BLVD., TAMPA, FL 33603
REGISTERED PROFESSIONAL ENGINEER
NOVEMBER 21, 1990
1/16/2020
21650

PROJECT #: 190420
RCC-60 TALL 20/20 IMAGE
NOVEMBER 2018 DESIGN RELEASE
BURGER KING
2413 NORTH HILLS STREET
MERIDIAN, MS 39305
HOOD DETAILS

© Copyright 2020- Drawings, specifications, notes, database, computer files, field data, and reports as instruments of service prepared by the Design of Record. As instruments of service, these items remain the property of the Design of Record, who shall retain all statutory and other reserved rights, including the copyright thereto. Any use, reproduction or changes to these documents without written consent of NCA Consultants is a violation of federal copyright laws.