

7 DUMPSTER BOLLARD DETAIL
A-402 SCALE: 1/2" = 1'-0"

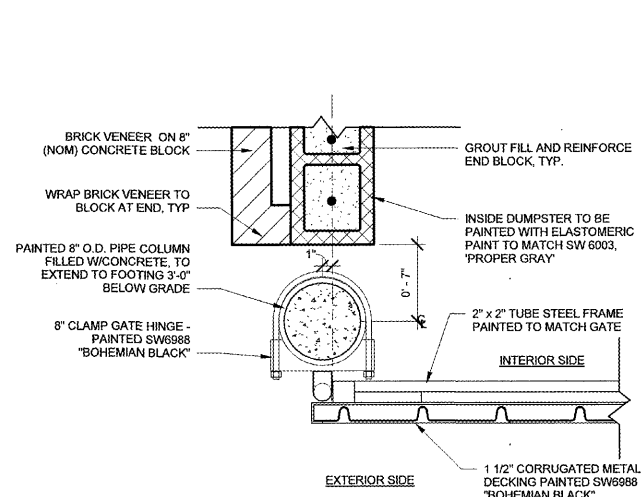

4 DUMPSTER GATE DETAIL
A-402 SCALE: 1 1/2" = 1'-0"

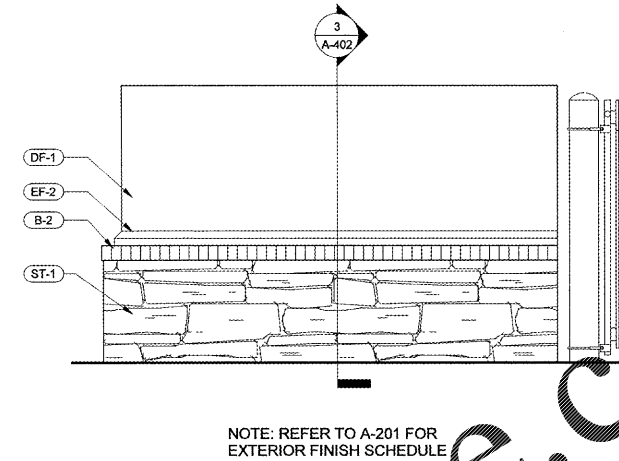

2 DUMPSTER ENCLOSURE ELEVATION
A-402 SCALE: 1" = 1'-0"

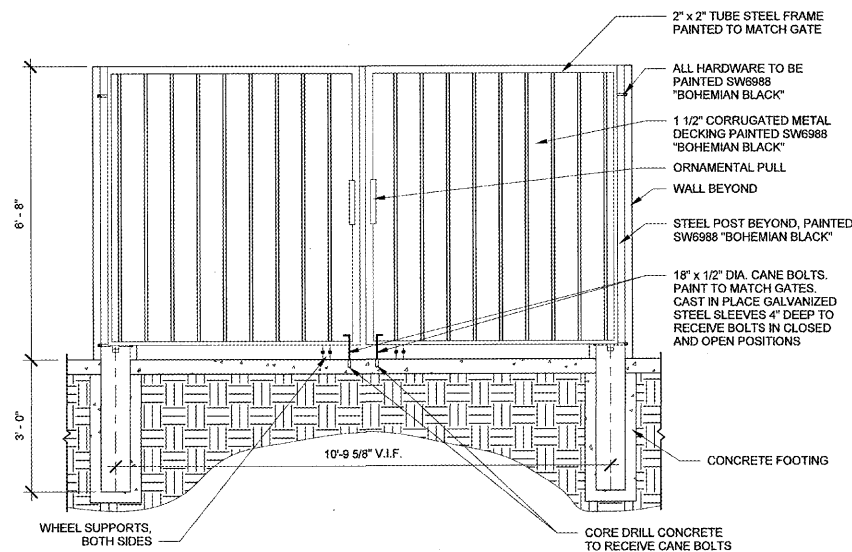

6 DUMPSTER GATE ELEVATION
A-402 SCALE: 1/2" = 1'-0"

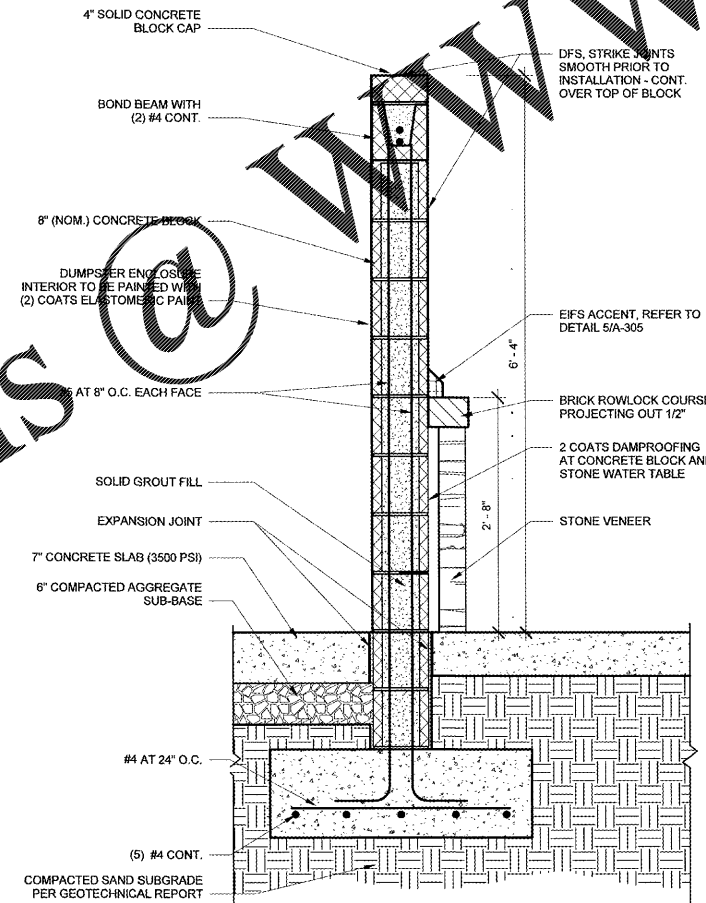

3 DUMPSTER ENCLOSURE SECTION
A-402 SCALE: 1" = 1'-0"

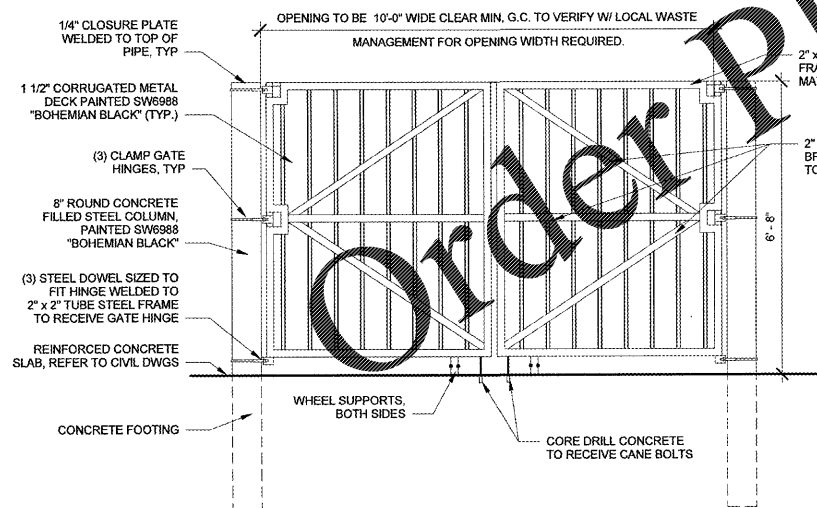

5 DUMPSTER GATE INTERIOR VIEW
A-402 SCALE: 1/2" = 1'-0"

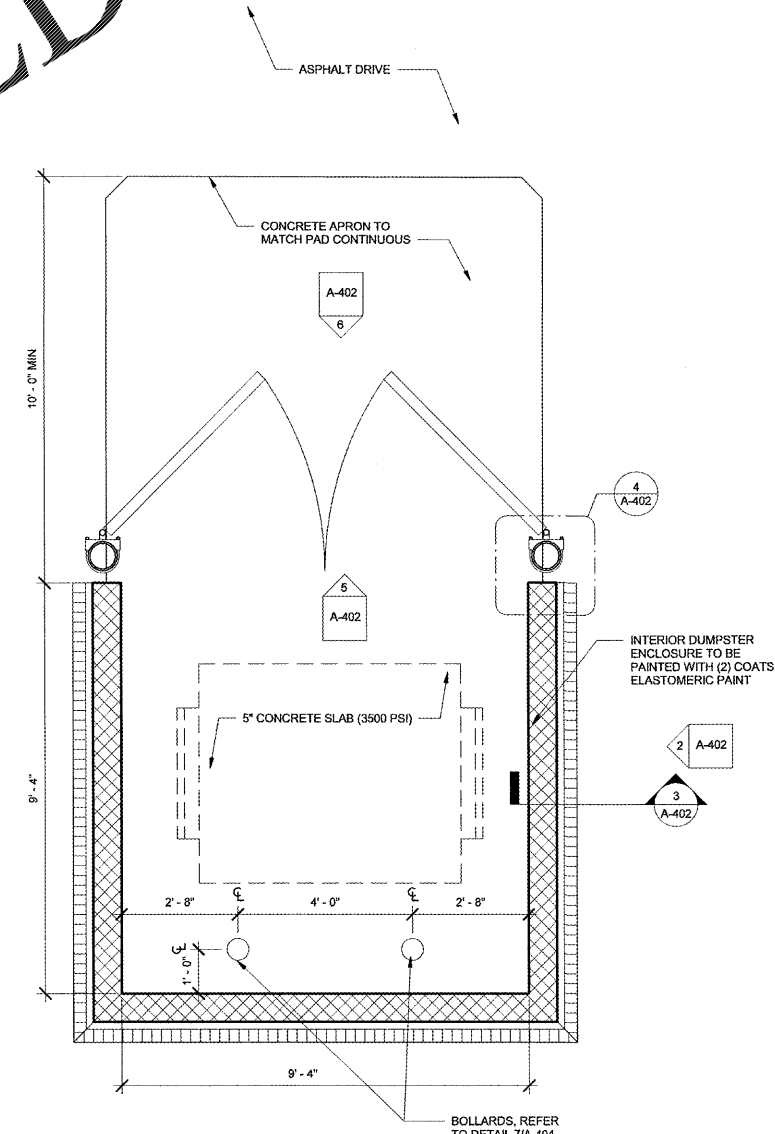

1 DUMPSTER ENCLOSURE PLAN
A-402 SCALE: 1/2" = 1'-0"

THIS DRAWING IS THE PROPERTY OF MAXDESIGN GROUP, AND IS NOT TO BE REPRODUCED IN WHOLE OR IN PART. IT IS NOT TO BE USED ON ANOTHER PROJECT AND SHALL BE RETURNED UPON REQUEST.

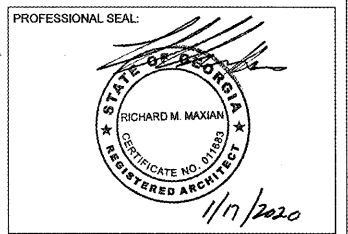

PROJECT TITLE:
BUTLER CREEK RETAIL BUILDING
ACWORTH, GEORGIA

PROJECT INFO:
3330 COBB PARKWAY NW
ACWORTH, GA 30144

PRINT RECORD	
Description	Date
ISSUED FOR PERMIT	01/17/2020

REVISION		
No.	Description	Date

DUMPSTER ENCLOSURE PLAN AND DETAILS

Project number: D19-127
Date: 01/17/2020
Drawn by: DKA
Checked by: RMM

A-402
Scale: As indicated

ISSUED FOR CONSTRUCTION