

**VEEDER-ROOT
GENERAL NOTES**

1. CHICO COMPOUND ALL EYE SEAL OFFS PER NFPA SPECIFICATION
2. RUN ONE CABLE FOR EACH TANK LEVEL MONITOR (TLM), LEAK SENSOR (LS), AND INTERSTITIAL SENSOR. NO SPLICES ARE ALLOWED IN CABLE RUN FROM MONITORING CONSOLE AND SENSOR JUNCTION BOX. IDENTIFY EACH CABLE WITH SENSOR TYPE AND LOCATION.
3. CONTACT FACTORY FOR CABLE RUNS GREATER THAN 100'
4. THE VEEDER-ROOT SITE MONITORING SYSTEM SHALL BE PROGRAMMED TO AUTOMATICALLY ALARM UPON DETECTION OF ANY TYPE OF LIQUID AT ANY SENSOR. ALL ALARMS WILL BE LOCAL, AUDIBLE, VISIBLE AND REMOTE OFF-SITE SENT TO OWNER'S OFF-SITE OPERATIONS OFFICE. ALARMS WILL NOTIFY IMMEDIATELY 24 HOURS A DAY, 7 DAYS A WEEK AT LOCAL AND REMOTE LOCATIONS.
5. LABEL ALL SENSOR LOCATIONS OF THE INSIDE OF THE VEEDER-ROOT PANEL DOOR IN THE AREA PROVIDED BY VEEDER-ROOT.
6. VEEDER-ROOT SYSTEMS AND ALL SENSORS ARE SUPPLEMENTED BY OTHER SENSORS AND MUST BE INSTALLED BY GENERAL CONTRACTOR.
7. EYE SEAL OFFS MUST BE INSTALLED AT ALL WIRE CONNECTIONS AFTER AUTHORIZED SERVICE PERSONNEL (A.S.P.) HAS STARTED THE SITE MONITORING SYSTEM. A BARE GROUND WIRE MUST BE INSERTED IN THE EPOXY UP TO AND INCLUDING INSULATION AND CABLE JACKET. REF 3-FSES
8. INSTALLATION SHOULD BE BASED ON THE MANUFACTURER'S RECOMMENDATION AND INSTALLATION MANUAL OF THE VEEDER-ROOT SYSTEM. DEVIATION FROM THESE RECOMMENDATIONS, INCLUDING THE INSTALLATION OR USE OF NON-APPROVED COMPONENTS, COULD RESULT IN UNSAFE CONDITIONS OR UNRELIABLE OPERATION.
9. INSTALLATION SHALL COMPLY WITH THE NATIONAL ELECTRICAL CODE, FEDERAL, STATE, LOCAL CODES, AND ANY OTHER APPLICABLE SAFETY CODES.

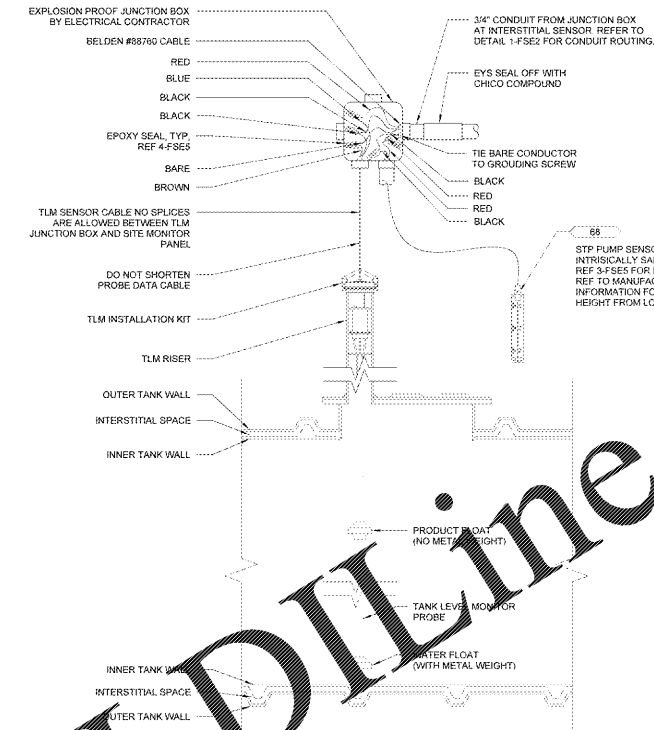

7 TANK LEVEL MONITOR & SUMP SENSOR AT SPLIT TANK
NTS

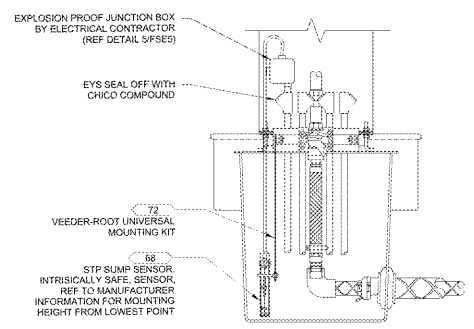

6 STP SUMP SENSOR MOUNTING DETAIL
NTS

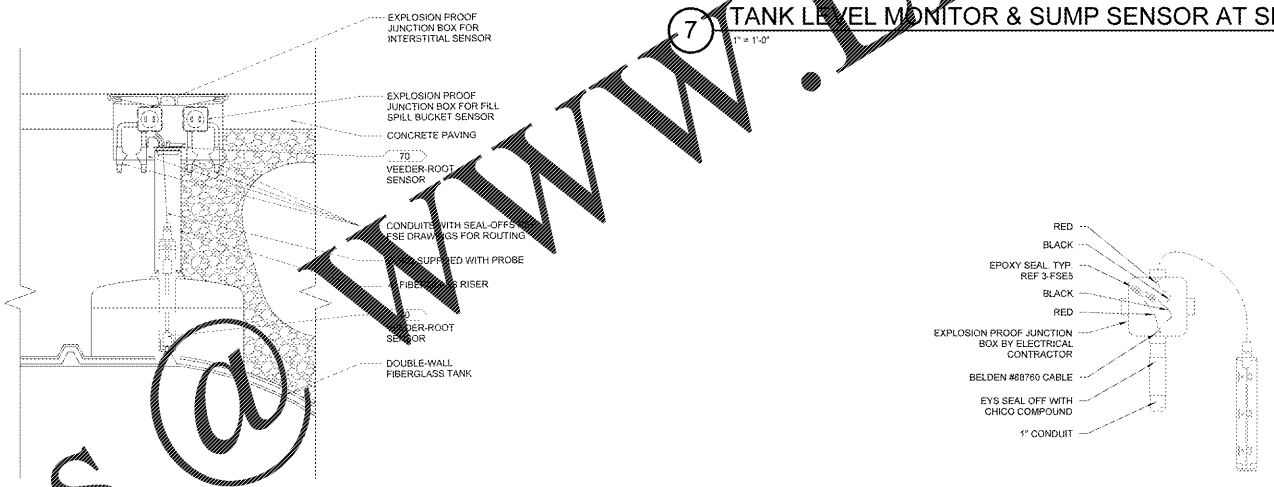

5 TANK HYDROSTATIC SENSOR MOUNTING DETAIL (TYPICAL)
NTS

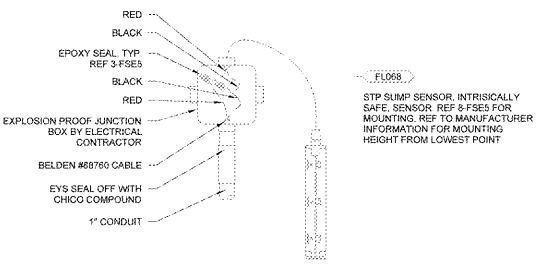

4 STP SUMP SENSOR MOUNTING DETAIL
NTS

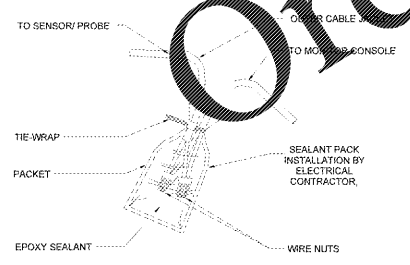

3 WIRE CONNECTION EPOXY SEAL DETAIL
NTS

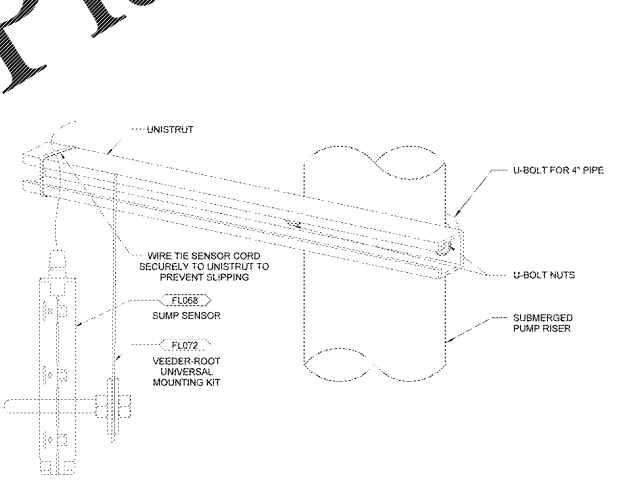

2 SPLIT TANK SENSOR SUPPORT
NTS

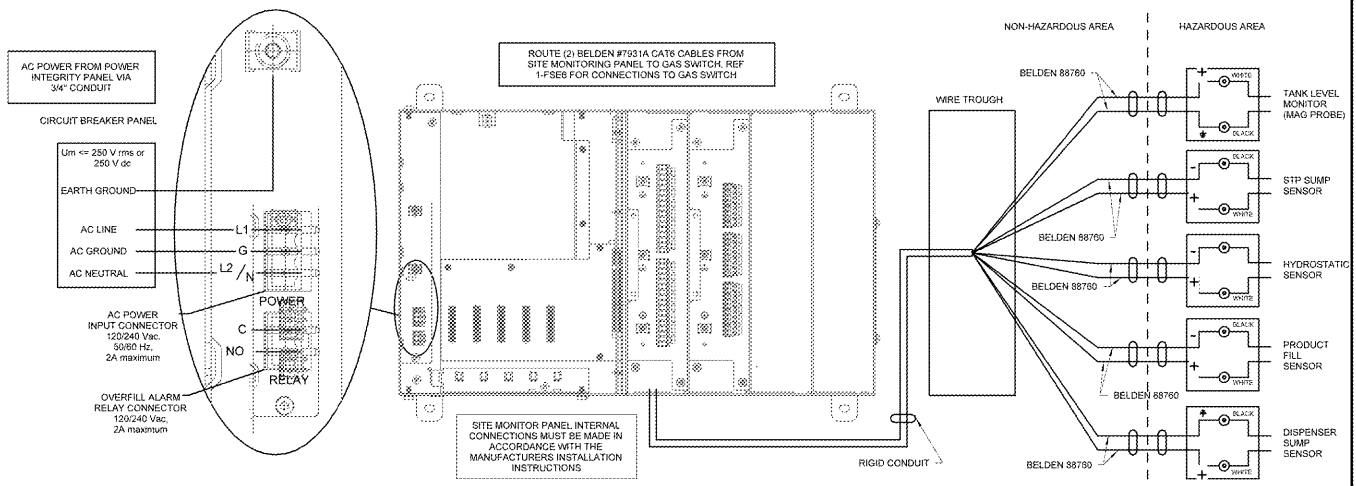

1 VEEDER-ROOT CONSOLE (SITE MONITOR PANEL)
NTS

VEEDER-ROOT
GENERAL NOTES

VEEDER-ROOT
GENERAL NOTES

VEEDER-ROOT
GENERAL NOTES

VEEDER-ROOT
GENERAL NOTES

VEEDER-ROOT
GENERAL NOTES

VEEDER-ROOT
GENERAL NOTES

VEEDER-ROOT
GENERAL NOTES

VEEDER-ROOT
GENERAL NOTES

VEEDER-ROOT
GENERAL NOTES

Order Plans

www.LDOnline.com

SITE MONITORING WIRING DIAGRAM

SHEET: FSE5