

REINFORCED CONCRETE PIPE (RCP)
N.T.S.

ALL OTHER PIPES
N.T.S.

GENERAL NOTES

- BEDDING SHALL BE CLASS I WORKED BY HAND OR CLASS II COMPACTED TO 95% STANDARD PROCTOR.
- HAUNCHING SHALL BE WORKED AROUND THE PIPE BY HAND TO ELIMINATE VOIDS AND SHALL BE CLASS I OR CLASS II COMPACTED TO 90% PROCTOR.
- INITIAL BACKFILL SHALL BE CLASS I WORKED BY HAND OR CLASS II COMPACTED TO 90% STANDARD PROCTOR.
- INITIAL BACKFILL NOT UNDER PAVED AREAS CAN BE CLASS III COMPACTED TO 90% STANDARD PROCTOR.
- FINAL BACKFILL SHALL BE CLASS I, II, OR III COMPACTED TO 95% STANDARD PROCTOR.
- FINAL BACKFILL NOT UNDER PAVED AREAS CAN BE CLASS IV COMPACTED TO 95% STANDARD PROCTOR.
- ALL MATERIALS ARE CLASSIFIED IN ACCORDANCE WITH ASTM D 2321-11.
- ALL MATERIALS SHALL BE INSTALLED IN MAXIMUM 8' LOOSE LIFTS IN ACCORDANCE WITH ASTM D 898, CLASS III AND IV MATERIALS SHALL BE COMPACTED NEAR OPTIMUM MOISTURE CONTENT.
- FILL SALVAGED FROM EXCAVATION SHALL BE FREE OF DEBRIS, ORGANICS AND ROCKS LARGER THAN 3".
- ALL TRENCH EXCAVATIONS SHALL BE SLOPED, SHORED, SHEETED, BRACED, OR OTHERWISE SUPPORTED IN COMPLIANCE WITH OSHA REGULATIONS AND LOCAL ORDINANCES. (SEE SPECIFICATIONS)
- ANY OPEN-GRADED MATERIAL MEETING THE REQUIREMENTS OF ASTM D 3321-11 MAY BE USED ONLY IF THE MATERIAL IS WRAPPED IN AN APPROVED FILTER OR DRAINAGE FABRIC (REFER TO SITEWORK SPECIFICATION SECTION 02300 FOR TYPE) AND WITH WRITTEN PERMISSION FROM THE C.E.
- THE UPPER 12" OF FINAL BACKFILL (MAY BE REDUCED TO 9" IN LIMITED AREAS WHERE BURIAL DEPTH WILL NOT ALLOW FOR 12" CAP) FOR ALL TRENCHES IN NON-PAVED AREAS SHALL BE A LOW PLASTICITY COHESIVE FILL. REFER TO SITEWORK SPECIFICATION SECTION 02300 FOR ALLOWABLE "SATISFACTORY MATERIALS" AND COMPACTION REQUIREMENTS.
- BEDDING, HAUNCHING, AND INITIAL AND FINAL BACKFILL MATERIALS USED IN CONJUNCTION WITH ANY PIPES WHICH PENETRATE A LEVEE OR ROAD EMBANKMENT, SHALL BE A LOW PERMEABILITY, COHESIVE SOIL. SOILS EXHIBITING HIGH SHRINK/SWELL POTENTIAL OR CONTAINING GREATER THAN 5% ORGANICS SHALL NOT BE USED.

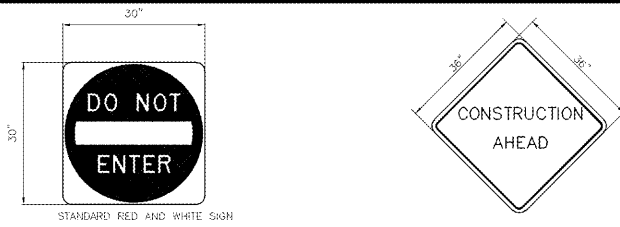

R5-1
"DO NOT ENTER" SIGN
N.T.S.

"CONSTRUCTION AHEAD" SIGN
N.T.S.

SIGNAGE

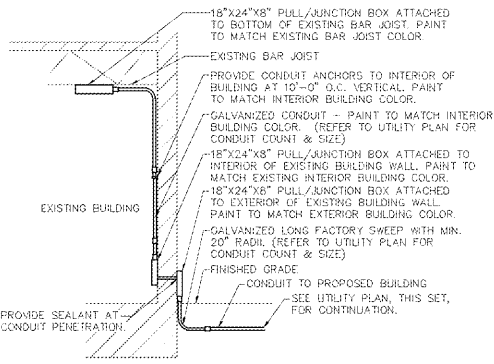

UTILITY ENTRY

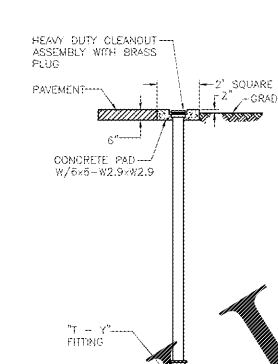

STORM SEWER CLEANOUT

STORM SEWER TRENCHING & BEDDING

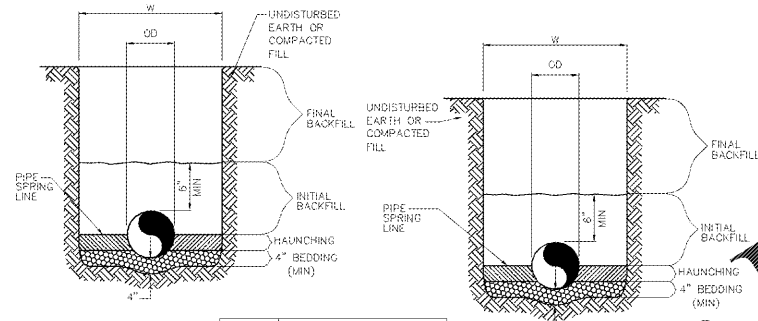

WATER LINE
N.T.S.

SANITARY
N.T.S.

GENERAL NOTES

- BEDDING SHALL BE CLASS I-A WORKED BY HAND, IF GROUNDWATER IS ANTICIPATED, THEN BEDDING SHALL BE CLASS I-B COMPACTED TO 95% STANDARD PROCTOR.
- HAUNCHING SHALL BE WORKED AROUND THE PIPE BY HAND TO ELIMINATE VOIDS AND SHALL BE CLASS I-A OR CLASS I-B OR CLASS II COMPACTED TO 95% PROCTOR.
- INITIAL BACKFILL SHALL BE CLASS I-A WORKED BY HAND, OR CLASS I-B OR CLASS II COMPACTED TO 95% STANDARD PROCTOR.
- INITIAL BACKFILL NOT UNDER PAVED AREAS CAN BE CLASS III COMPACTED TO 95% STANDARD PROCTOR.
- FINAL BACKFILL SHALL BE CLASS I, II, OR III COMPACTED AS NOTED IN NOTES 3 AND 4.
- FINAL BACKFILL NOT UNDER PAVED AREAS CAN BE CLASS III COMPACTED TO 95% STANDARD PROCTOR.
- ALL MATERIALS ARE CLASSIFIED IN ACCORDANCE WITH ASTM D 2321-89.
- ALL MATERIALS SHALL BE INSTALLED IN MAXIMUM 8' LOOSE LIFTS IN ACCORDANCE WITH ASTM D 898, CLASS III AND IV MATERIALS SHALL BE COMPACTED NEAR OPTIMUM MOISTURE CONTENT.
- FILL SALVAGED FROM EXCAVATION SHALL BE FREE OF DEBRIS, ORGANICS AND ROCKS LARGER THAN 3".
- ALL TRENCH EXCAVATIONS SHALL BE SLOPED, SHORED, SHEETED, BRACED, OR OTHERWISE SUPPORTED IN COMPLIANCE WITH OSHA REGULATIONS AND LOCAL ORDINANCES. (SEE SPECIFICATIONS)

UTILITY ENTRY

STORM SEWER CLEANOUT

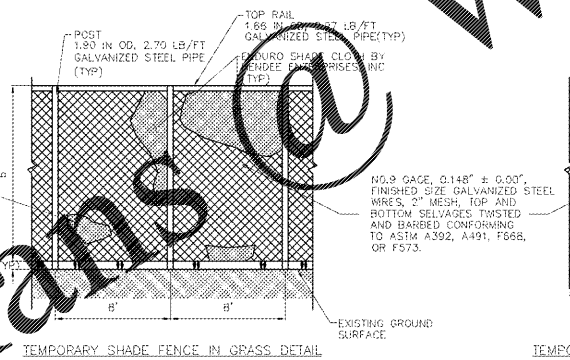

TEMPORARY SHADE FENCE IN GRASS DETAIL

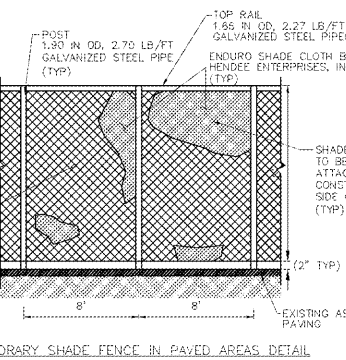

TEMPORARY SHADE FENCE IN PAVED AREAS DETAIL

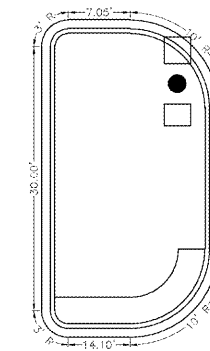

ISLAND 'A'

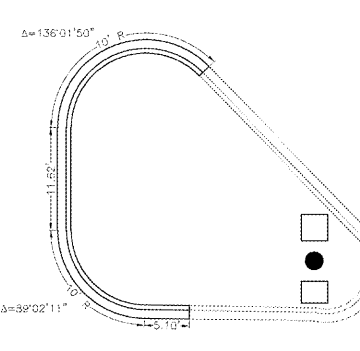

ISLAND 'B'

CURBED ISLAND DETAILS

SCALE: 1"=10'

- NOTES:
- ALL RADII ARE 3' U.N.O.
 - ALL DELTA ANGLES ARE 90' U.N.O.

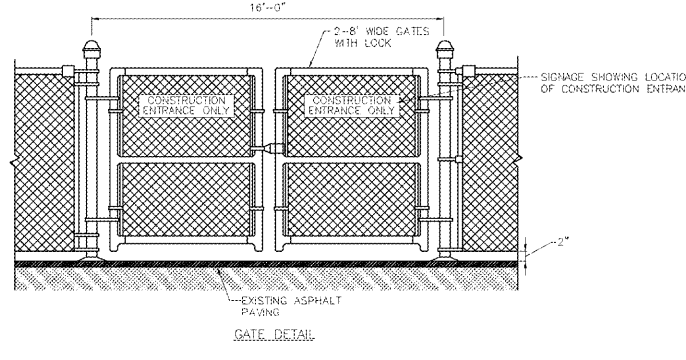

TEMPORARY CONSTRUCTION FENCE WITH GATE DETAIL
N.T.S.

UTILITY TRENCHING & BEDDING

TEMPORARY CONSTRUCTION FENCE

CURBED ISLAND DETAILS

DETAILS

REVISIONS	BY

CARLSON CONSULTING ENGINEERS, INC.
7068 LEDGESTONE COMMONS
BARTLETT, TENNESSEE 38133
PH. (901) 384-0404 • FX. (901) 384-0710
NORTH CAROLINA CORPORATION# C-3504

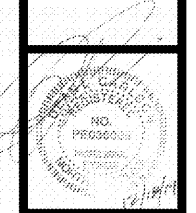

SAM'S CLUB #6540-209
CHARLOTTE, NORTH CAROLINA
SAM'S REAL ESTATE BUSINESS TRUST
2101 SE SIMPLE SAVINGS DRIVE
BENTONVILLE, AR 72716



DRAWN	TGH
CHECKED	BKM
DATE	12/17/2019
SCALE	NTS
JOB No.	6540-209
SHEET	18 OF 21