

RENOVATION AND
ADDITION FOR
**ABERDEEN
POLICE
DEPARTMENT**



ELECTRICAL
DETAILS

DATE: 10/25/2019
PROJECT NO: 18062

REVISIONS
NO. DATE DESCRIPTION:

THIS DRAWING IS THE PROPERTY OF ADW ARCHITECTS, P.A. AND SHALL NOT BE REPRODUCED OR COPIED IN WHOLE OR PART. IT SHALL NOT BE USED ON ANY OTHER PROJECT OR GIVEN TO ANY OTHER COMPANY OR AGENCY WITHOUT THE CONSENT OF ADW ARCHITECTS, P.A.

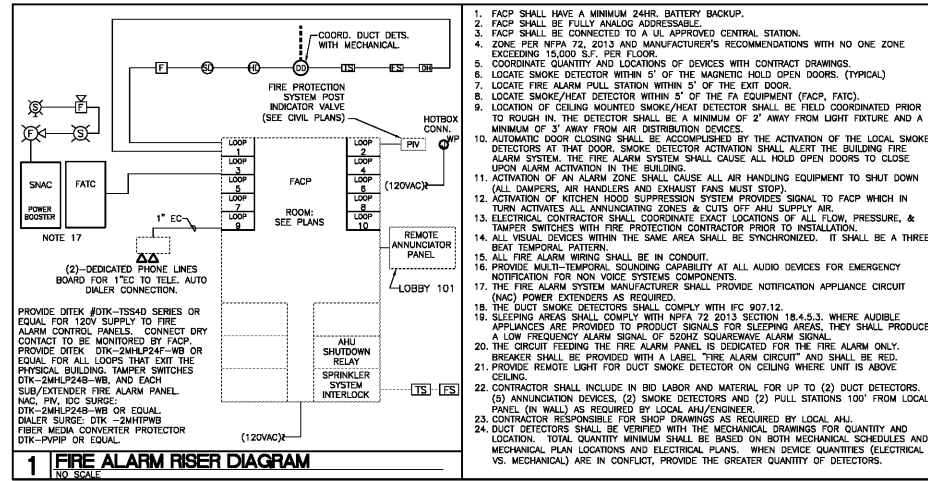

FIRE ALARM SYSTEM MATRIX	BUILDING SYSTEM OUTPUTS										CENTRAL COMM
	SMOKE DETECTOR	HEAT DETECTOR	PULL STATION	SMOKE/HEAT DETECTOR	SMOKE/HEAT DETECTOR	SMOKE/HEAT DETECTOR	SMOKE/HEAT DETECTOR	SMOKE/HEAT DETECTOR	SMOKE/HEAT DETECTOR	SMOKE/HEAT DETECTOR	
MANUAL FIRE ALARM PULL BOXES	X	X	X	X	X	X	X	X	X	X	
BUILDING SMOKE DETECTOR	X	X	X	X	X	X	X	X	X	X	
BUILDING CO DETECTOR	X	X	X	X	X	X	X	X	X	X	
BUILDING HEAT DETECTOR	X	X	X	X	X	X	X	X	X	X	
DUCT SMOKE DETECTOR	X	X	X	X	X	X	X	X	X	X	
HOOD SUPPRESSION SYSTEM	X	X	X	X	X	X	X	X	X	X	
NOTIFICATION DEVICE SHORT CIRCUIT	X	X	X	X	X	X	X	X	X	X	
OPEN CIRCUIT	X	X	X	X	X	X	X	X	X	X	
GROUND FAULT	X	X	X	X	X	X	X	X	X	X	
FIRE ALARM A.C. POWER FAILURE	X	X	X	X	X	X	X	X	X	X	
FIRE ALARM SYSTEM LOW BATTERY	X	X	X	X	X	X	X	X	X	X	
GENERATOR NFA 110 ALARM ACTIVE	X	X	X	X	X	X	X	X	X	X	
GENERATOR FUEL LEVEL	X	X	X	X	X	X	X	X	X	X	

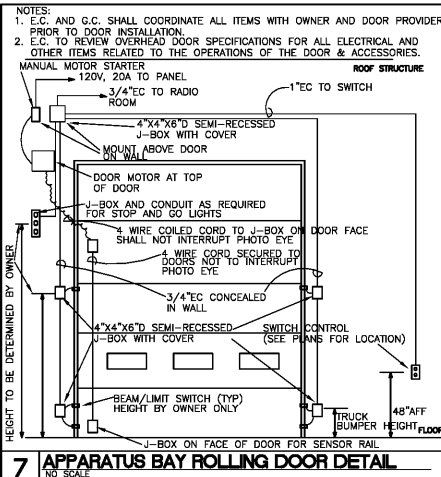
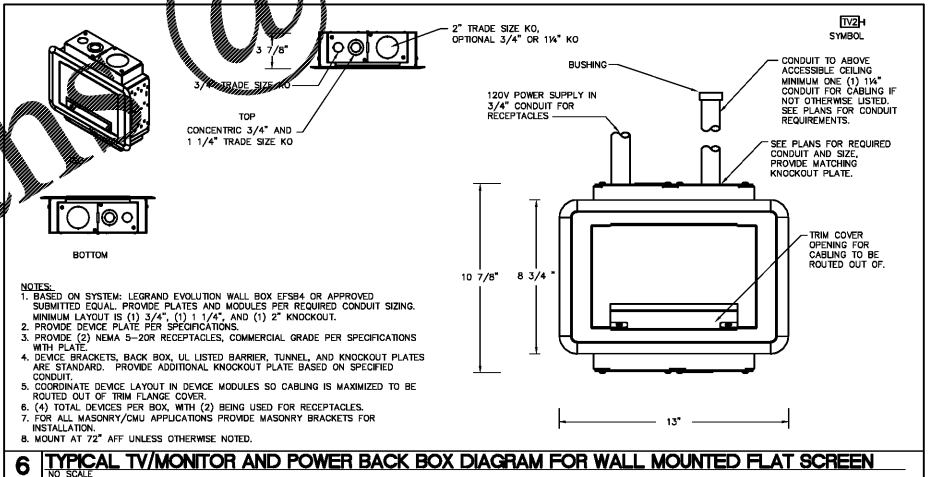
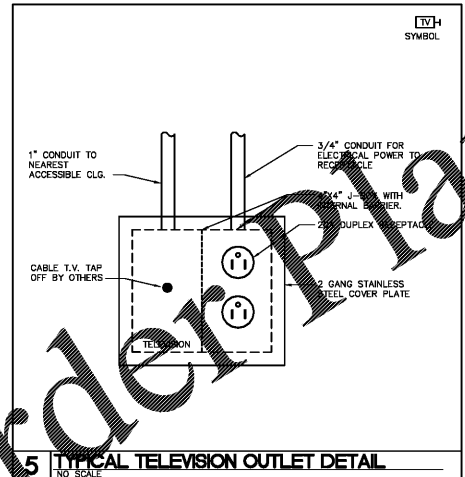
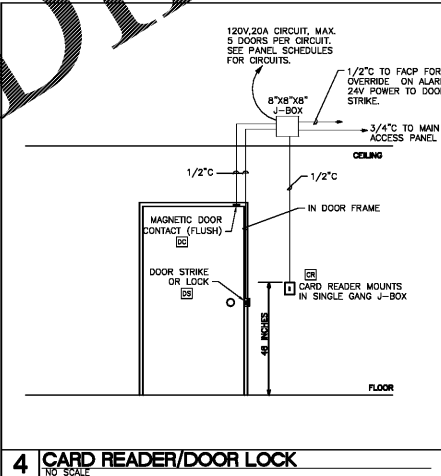
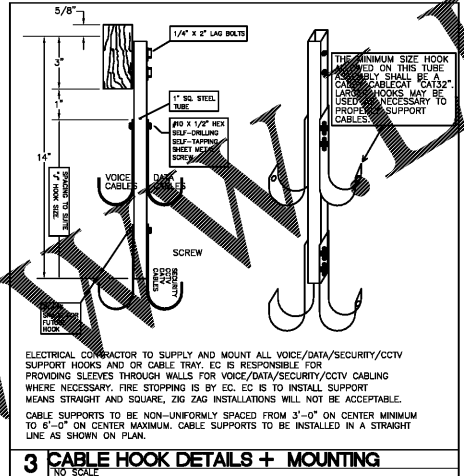
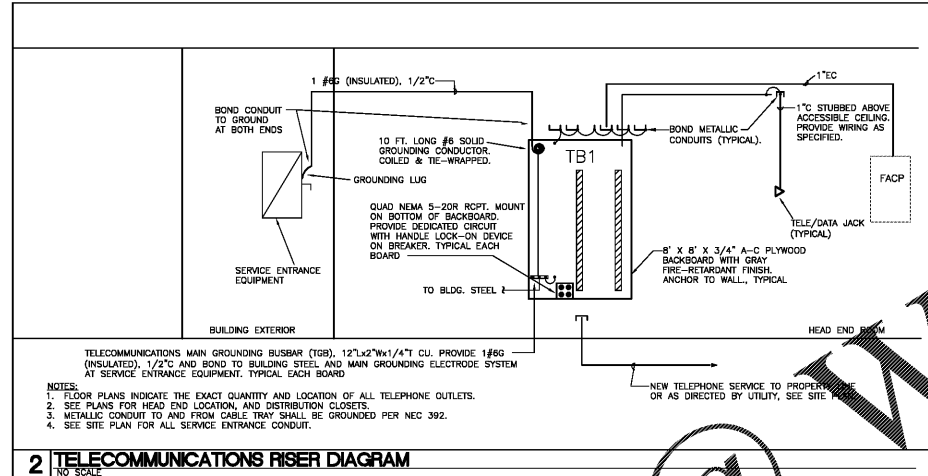

Order Plans @