

FINISH SCHEDULE										
ROOM NUMBER	FLOOR MATERIAL	BASE			WALL MATERIAL	CEILING MAT'L	CEILING HEIGHT	NOTE NUMBER		
		MATERIAL	WS	HT.						
	1) L.V.T. 2) RECESSED ALUMINUM 3) WALK OFF MAT 4) SEALED CONCRETE									
			1) RUBBER							
					1) PAINTED C.M.U. 2) PAINTED GYP. BD. 3) ARCH. PANELS 4) FRP BOARD					
						1) 2"x2" LAY IN CLG. 2) GYP. BD. PAINTED 3) PAINT STRUCTURE 4) SUSPENDED WOOD CLG. 5) M.R. LAY IN CLG.				
100	VESTIBULE	2					9'-10"			
101	CHECK-OUT	1					9'-4"			
102	SALES	1					12'-4"			
103	RECEIVING-STORAGE				1		12'-4"			NOTE 1
104	ELEC. ROOM				1		12'-4"			NOTE 1
105	TOILET				4		9'-0"			

NOTES
1) EPOXY PAINT

DOOR SCHEDULE													
DOOR NUMBER	DOOR TYPE	DOOR MATERIAL	GLASS & GLAZING	LOUVER		FRAME TYPE	FRAME MATERIAL	JAMB	HEAD	SILL	LABEL	HARDWARE SET	NOTE
				W	H								
100A	1	B	AL	1" insul/ temp.			A	AL					NOTE 1, 2
100B	1	B	AL	1" insul/ temp.			A	AL					NOTE 1, 2
100C	1	B	AL	1" insul/ temp.			A	AL					NOTE 1, 2
100D	1	B	AL	1" insul/ temp.			A	AL					NOTE 1, 2
102A	1	C	FG				1	HM					
102B	1	A	HM				1	HM					
103B	1	A	HM				1	HM					
104A	1	A	HM				2	HM					
105A	1	A	HM				2	HM					

DOOR SCHEDULE NOTES:
1) G.C., HARDWARE SUB. AND ELECTRICAL SUB TO COORDINATE SECURITY HARDWARE FOR DOOR.
2) APPLY BREAK-IN RESISTANT FILM AND ATTACHMENT SYSTEM TO ALL GLAZING ASSOCIATED WITH DOOR AND FRAME.

HM - HOLLOW METAL
AL - ALUMINUM
WD - WOOD
FG - FIBERGLASS

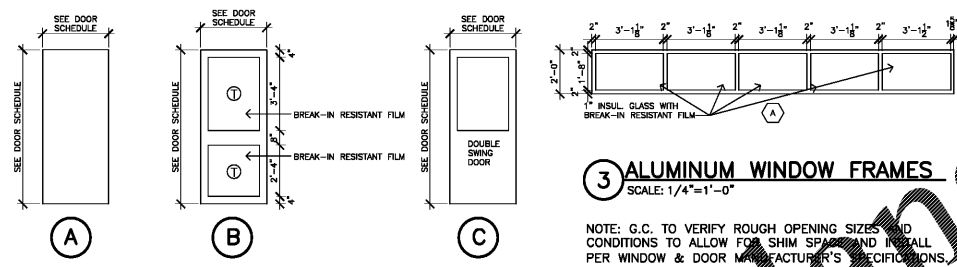

1) DOOR TYPES SCALE: 1/4"=1'-0"

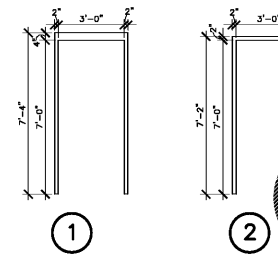

2) H.M. FRAME TYPES SCALE: 1/4"=1'-0"

4) ALUM. DOOR SCALE: 1/4"=1'-0"

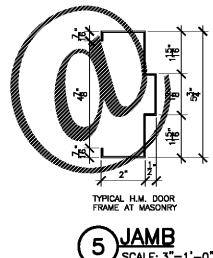

5) JAMB SCALE: 3"=1'-0"

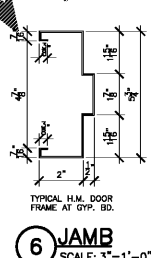

6) JAMB SCALE: 3"=1'-0"

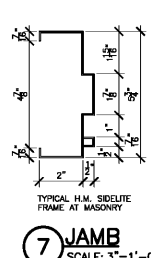

7) JAMB SCALE: 3"=1'-0"

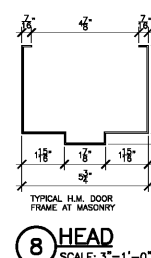

8) HEAD SCALE: 3"=1'-0"

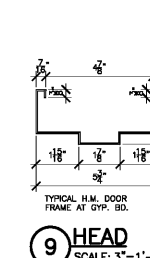

9) HEAD SCALE: 3"=1'-0"

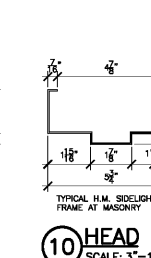

10) HEAD SCALE: 3"=1'-0"

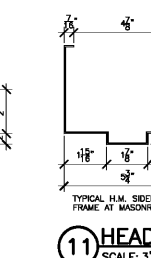

11) HEAD SCALE: 3"=1'-0"

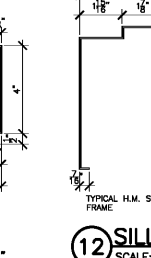

12) SILL SCALE: 3"=1'-0"

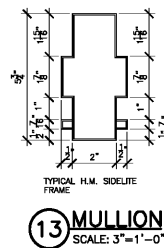

13) MULLION SCALE: 3"=1'-0"

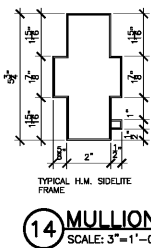

14) MULLION SCALE: 3"=1'-0"

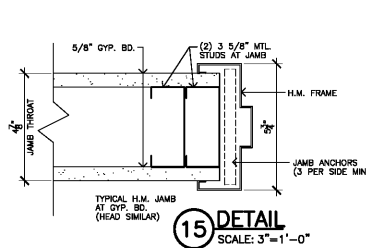

15) DETAIL SCALE: 3"=1'-0"

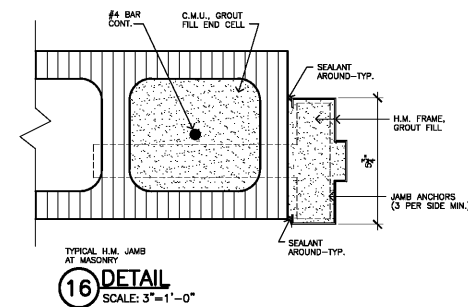

16) DETAIL SCALE: 3"=1'-0"

Order Plans

WWW.LDILine.com

These drawings are instruments of service and as such remain the property of the architect. No copies or reproductions of these drawings are permitted without the consent of the architect. Upon completion of the work all the drawings (except the contract copies) are to be returned to the architect.
Copyright © 2019

DOOR AND FINISH SCHEDULE

RENOVATIONS AND ADDITIONS TO:

HOLLOWAY STREET ABC STORE

1928 HOLLOWAY ST. DURHAM, NC

PROJECT NUMBER 19002



DTW Architects & Planners, Ltd.
229 North Gregson Street
Durham, NC 27701
919.317.4020

BID DOCUMENTS FOR PERMIT

Revisions
Drawn I.L.V.
Checked J.P.Y.
Date 12/22/19
Sheet