

1 / C801
NCDOT CURB AND GUTTER
NTS

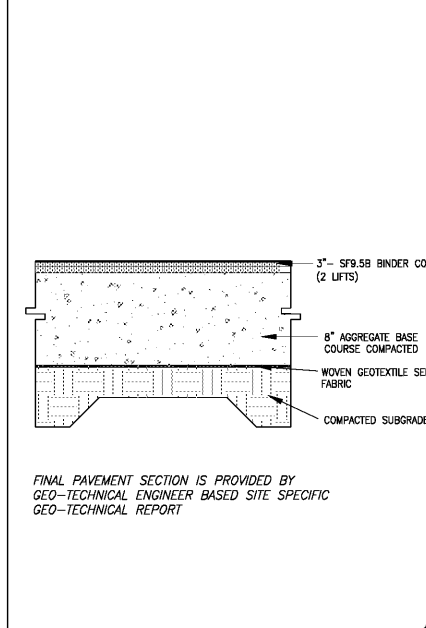

2 / C801
4\"/>

3 / C801
HEAVY DUTY ASPHALT PAVING
NTS

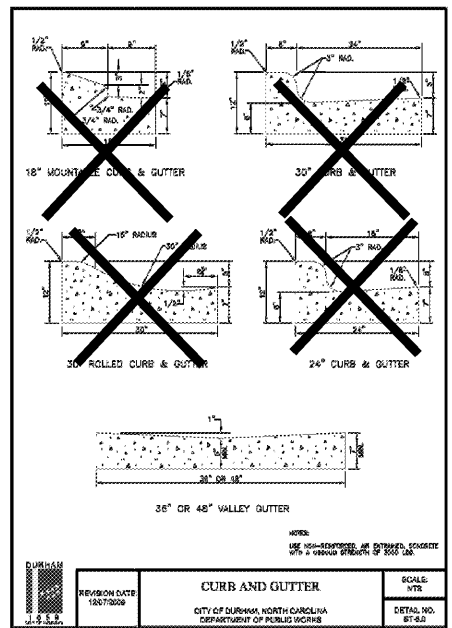
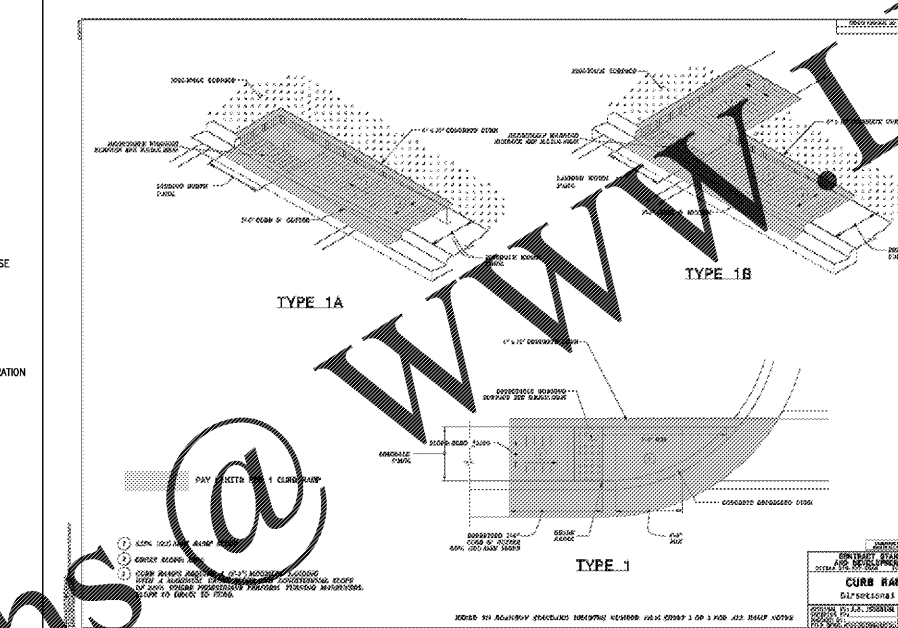

4 / C801
DIRECTIONAL CURB RAMP
NTS

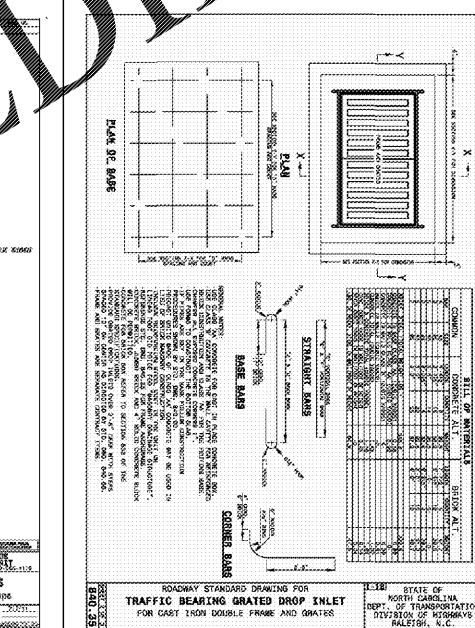

5 / C801
NCDOT TRAFFIC BEARING GRATED DROP INLET
NTS

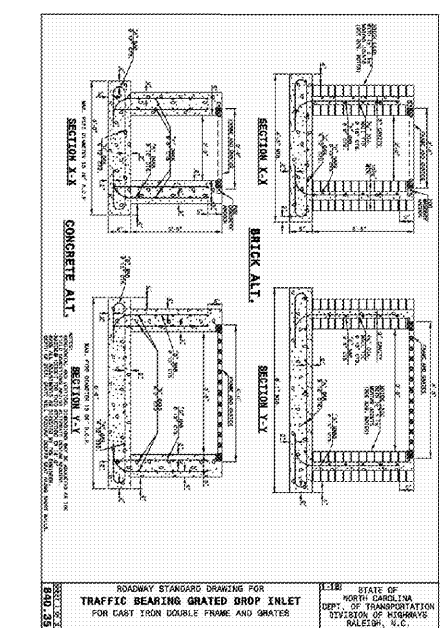

6 / C801
NCDOT TRAFFIC BEARING GRATED DROP INLET
NTS

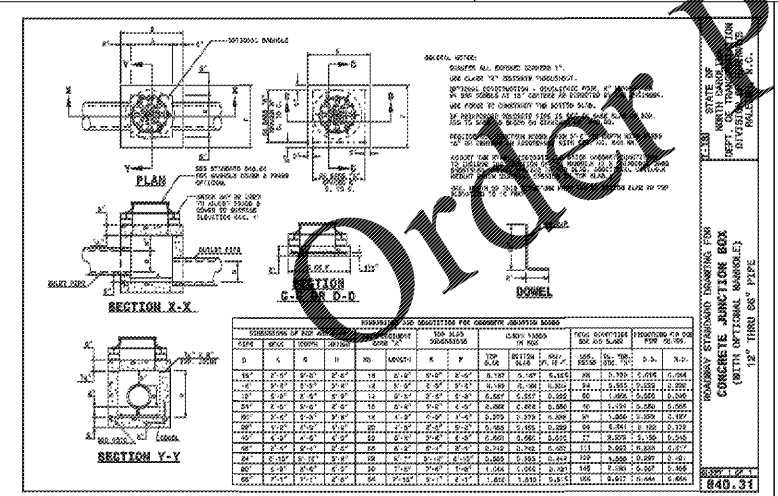

6 / C801
NCDOT JUNCTION BOX
NTS

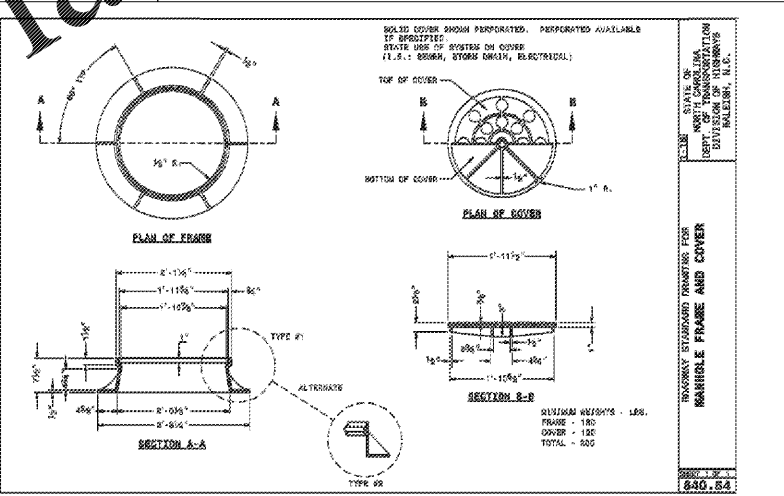

7 / C801
NCDOT MANHOLE FRAME AND COVER
NTS

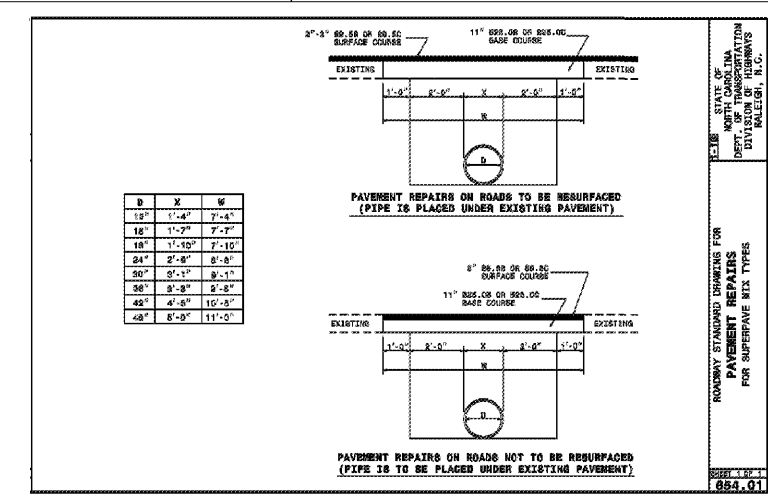

8 / C801
NCDOT PAVEMENT REPAIR
NTS



Coulter Jewell Thames, Inc.
111 West Main Street
Durham, N.C. 27701
p 919.682.0368
f 919.688.5646
www.cjtpa.com

NC BOARD OF EXAMINERS FOR ENGINEERS AND SURVEYORS LIC# C-1209
NC BOARD OF LANDSCAPE ARCHITECTS LIC# 104

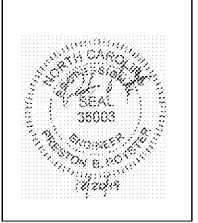

Project
HOLLOWAY STREET ABC STORE
1928 AND 1930 HOLLOWAY STREET
DURHAM, NC 27707
DURHAM COUNTY NC

P.I.N. 0831-12-95-2949
0831-12-95-3944

Job Number 1865
Drawn AJP, ED
Checked AJP, PBR
Date 10/11/2019
Revisions 1. 10/29/2019 COMMENTS
2. 11/21/2019 COMMENTS
3. 12/20/2019 BID PLANS

CONSTRUCTION DRAWINGS NOT ISSUED FOR CONSTRUCTION

Sheet Title
SITE DETAILS

Sheet Number
C801