

EDGE ANGLE SCHEDULE

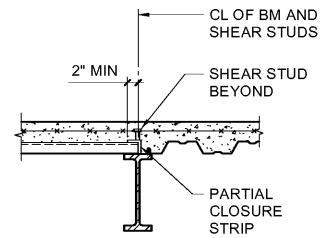

FLANGE < 6"

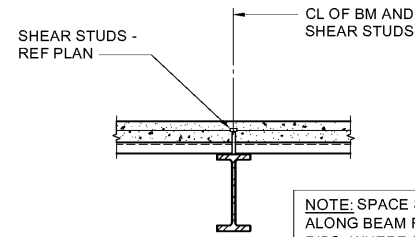

PERPENDICULAR

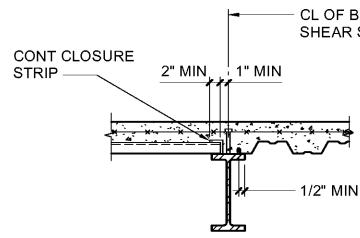

FLANGE > 6"

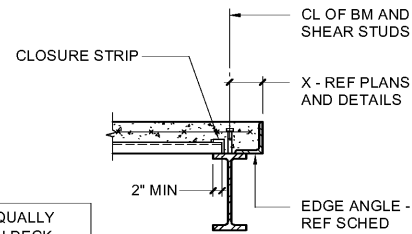

EDGE PERPENDICULAR

NOTE: SPACE STUDS EQUALLY ALONG BEAM FLANGE IN DECK RIBS. WHERE SPACING EXCEEDS 32\"/>

TYPICAL COMPOSITE SLAB DETAILS

NTS

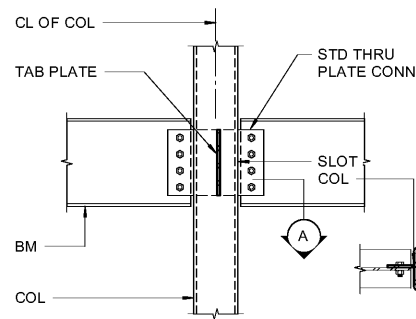

INTERMEDIATE

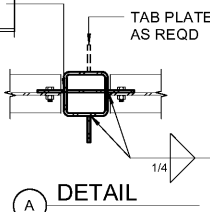

DETAIL A

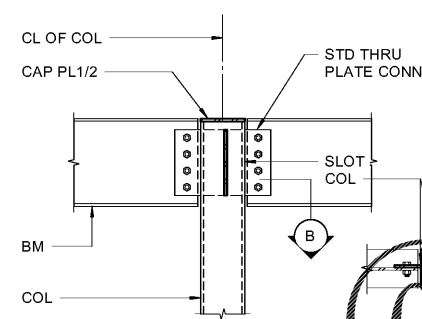

TOP

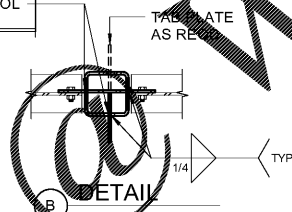

DETAIL B

TYPICAL BEAM TO HSS COLUMN CONNECTION DETAILS

NTS

Order Plans

WWW.LDILine.com

SEALS

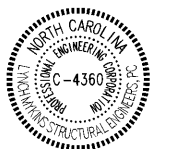

DKA JOB NUMBER

1915

REVISIONS

NO.	DESCRIPTION

These drawings are the property of Davis Kone Architects, P.A. They may not be re-used for any purpose without written permission.
Copyright © 2019 by Davis Kone Architects, P.A. All rights reserved.

PE:
PM:
Drawn By:
Plot Date: 10/18/2019 4:42:27 PM

DATE ISSUED

BID DOCUMENTS
10/22/19

SHEET TITLE

TYPICAL DETAILS

S502