

Order Plans

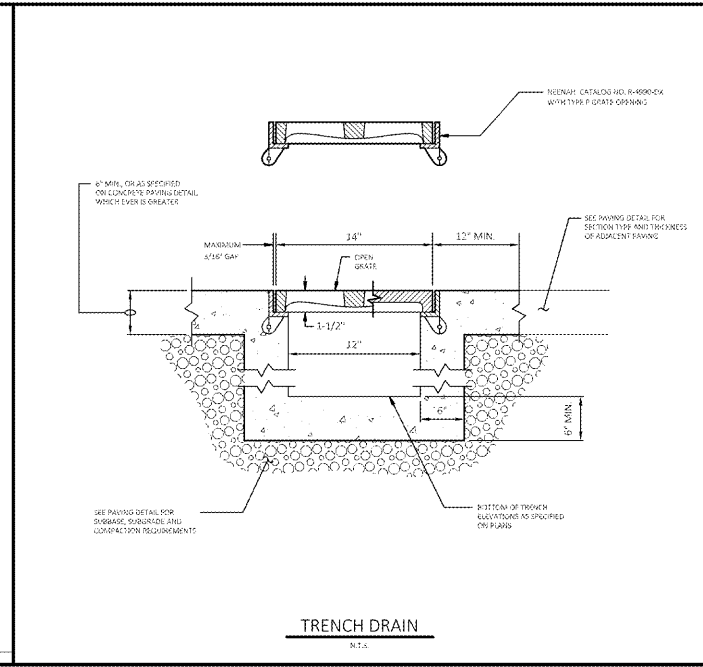
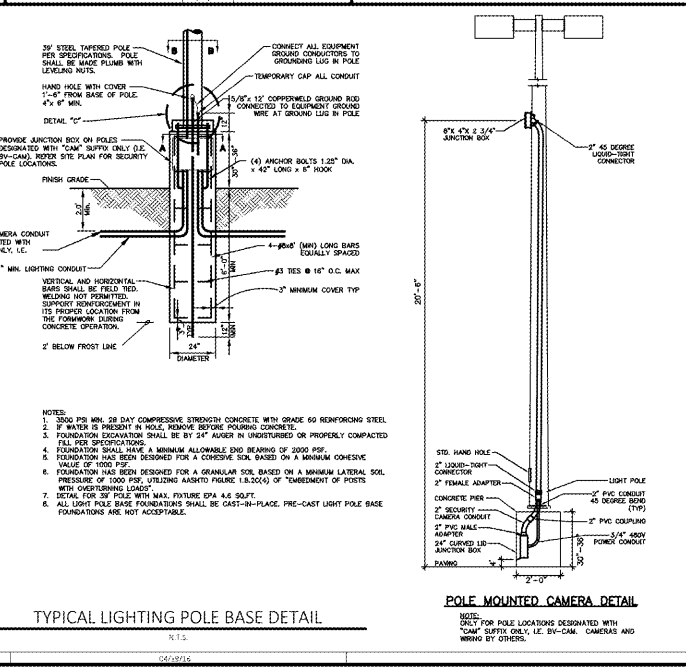
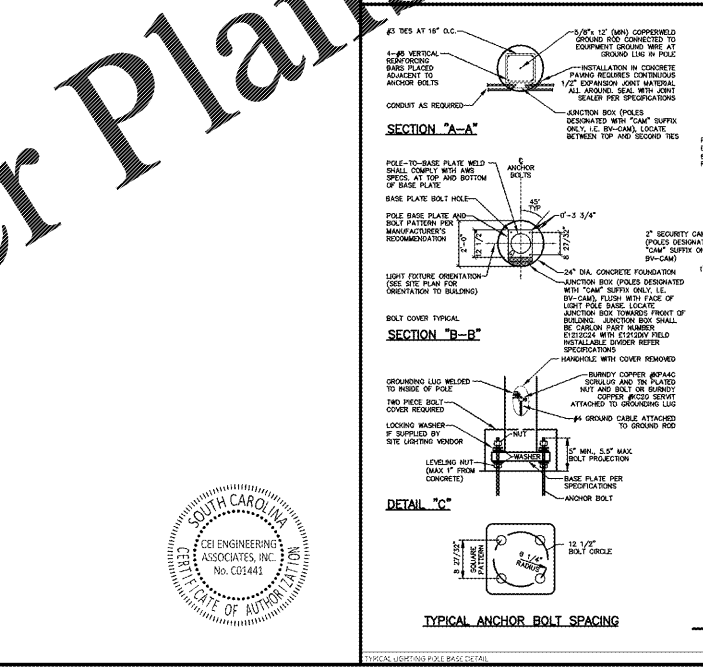
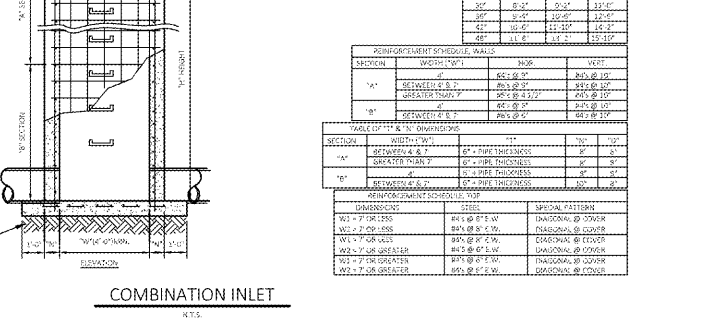
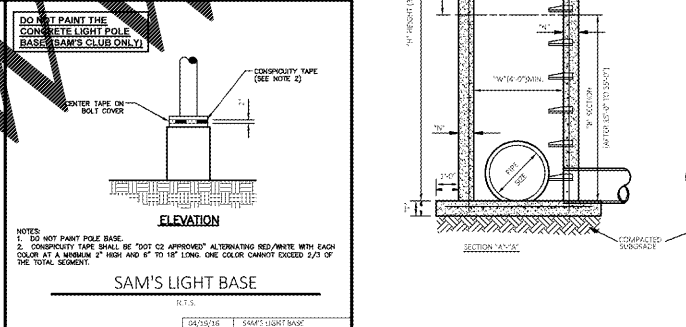
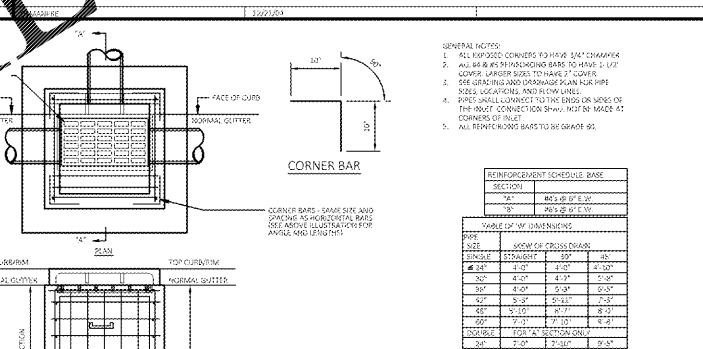
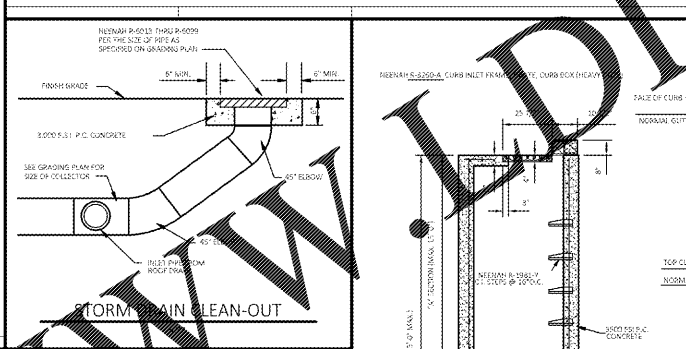
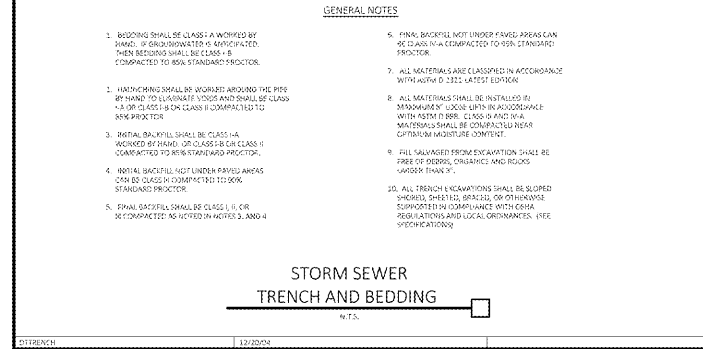
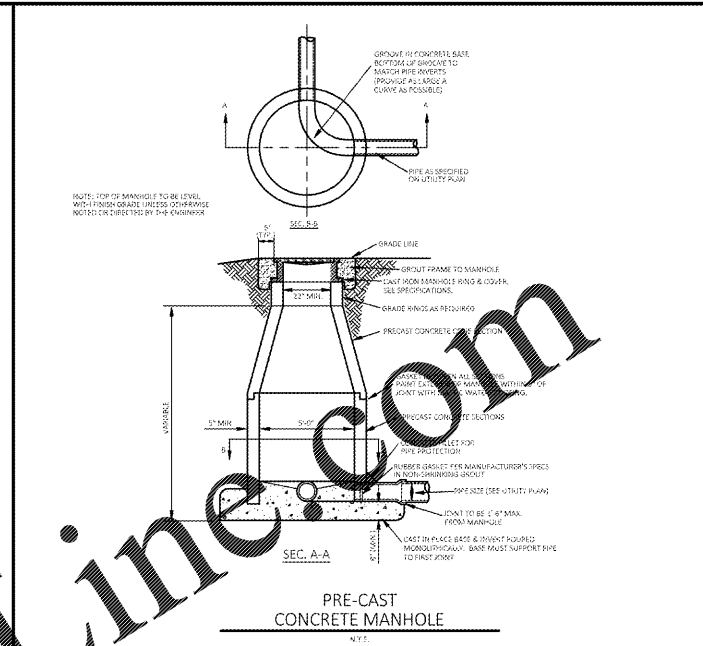
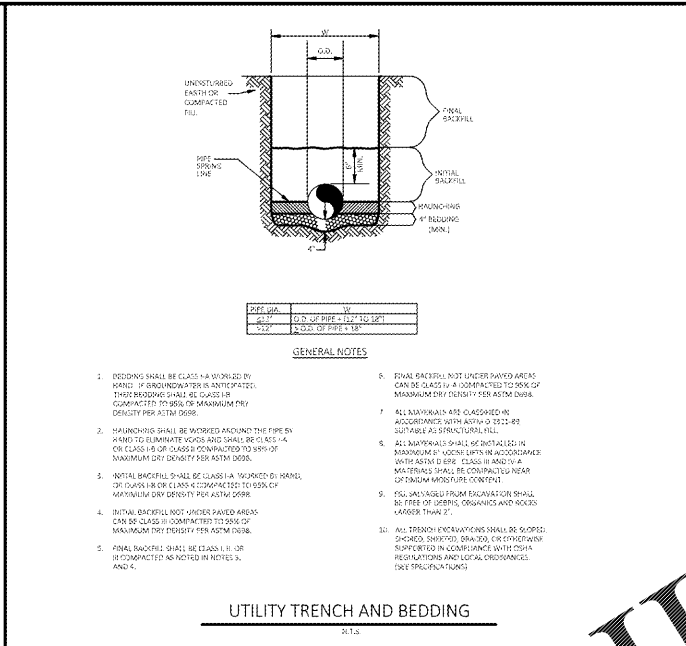
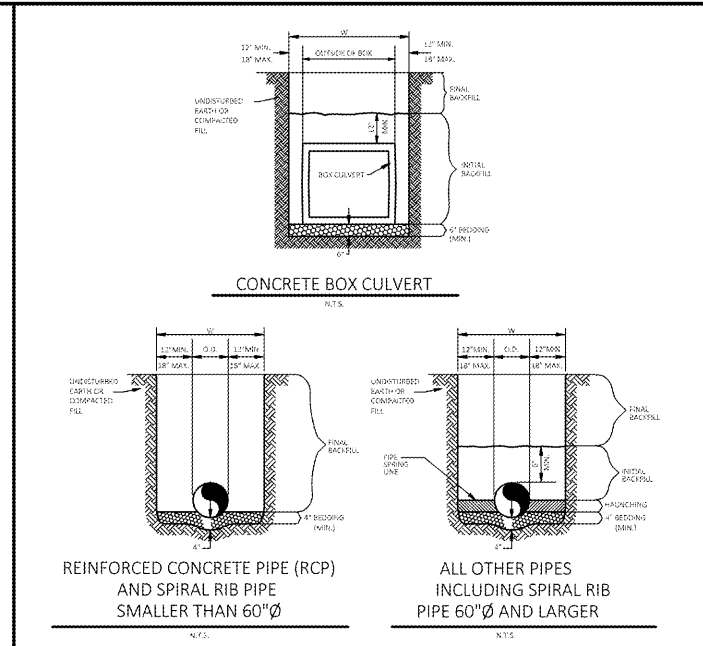

REVISIONS

NO.	DATE	DESCRIPTION

**Engineering Associates, Inc.**  
ENGINEERS • PLANNERS • SURVEYORS  
LANDSCAPE ARCHITECTS • ENVIRONMENTAL SCIENTISTS

7445 N. Ingram Ave., Suite 107  
Fresno, CA 93711  
(559)442-3119  
FAX: (559)442-3129

**SAMS CLUB FUEL STATION #6643-502**

**DETAIL SHEET**

3012 LIBERTY HWY #6  
ANDERSON SOUTH CAROLINA

**Sams CLUB**

INITIAL DESIGN: 11/5/19  
DATE: 11/5/19

JOB	JPD	JAP	DV
DPOR	PM	DES	DRW

JOB NO.: 31076  
DWS NAME: 31076-D7

DATE: 11/5/19 10:17 AM  
SHEET NO.: C8

JOB # 31076 DRAWING: 31076-D7.DWG LAST SAVED BY: ANDERSON

