

NOTES:
1. WORDS AND ARROWS SHALL BE APPLIED IN ACCORDANCE WITH SECTION 3R.20 OF THE MANUAL ON UNIFORM TRAFFIC CONTROL DEVICES FOR STREETS AND HIGHWAYS.
2. THESE WORDS ARE TO BE PAINTED "RETROREFLECTIVE WHITE WITH GLASS BEADS", PER SPECIFICATIONS, WHEN AT EXITS FROM PARKING LOT TO PUBLIC STREETS.

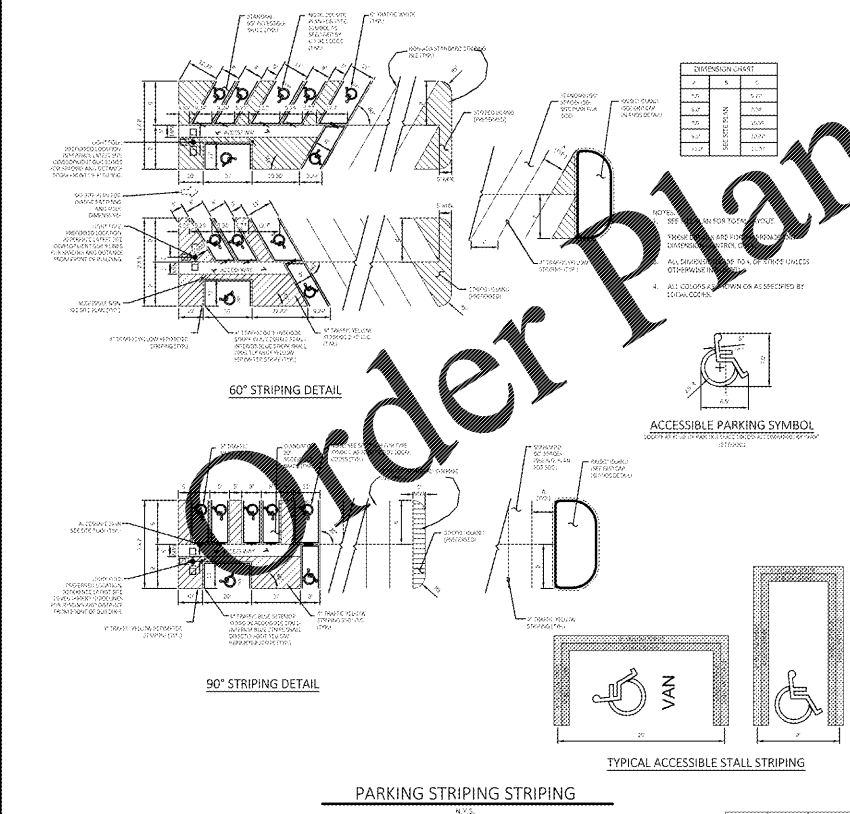
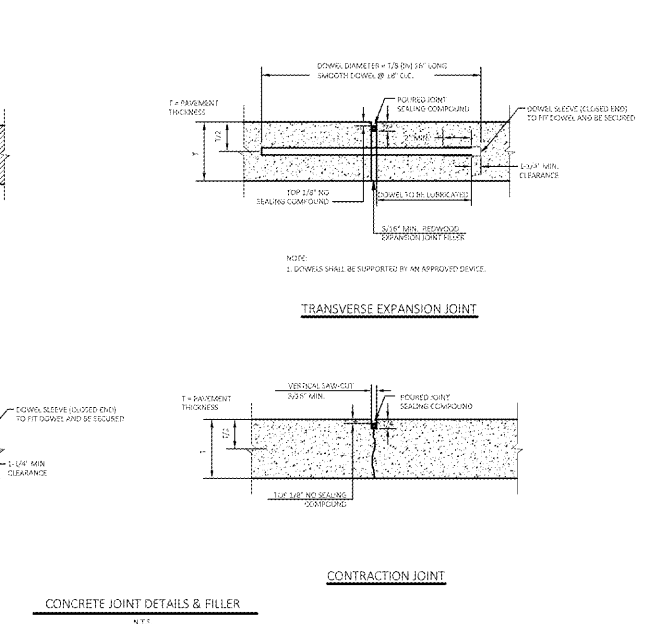
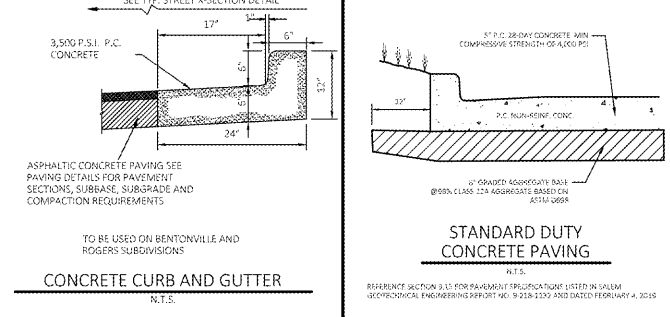
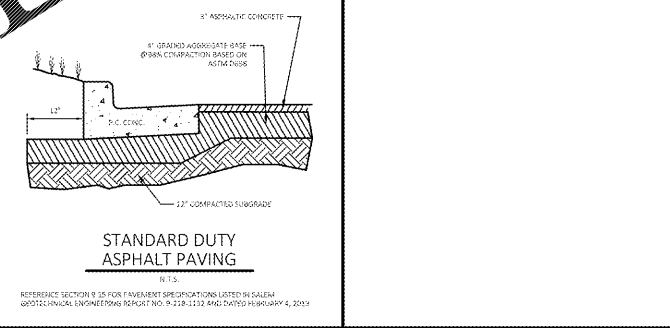
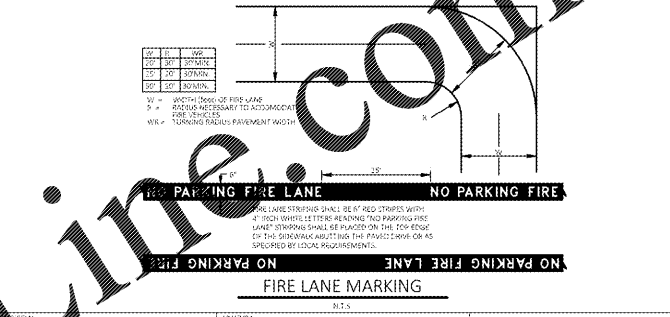
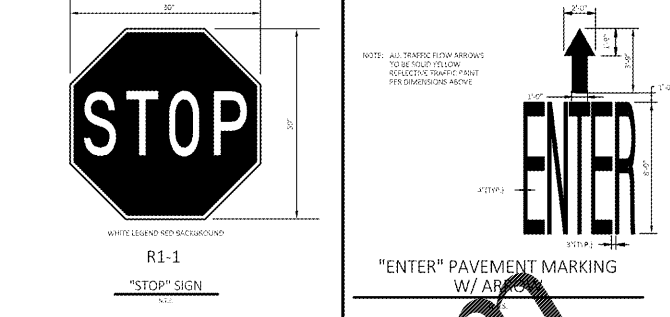
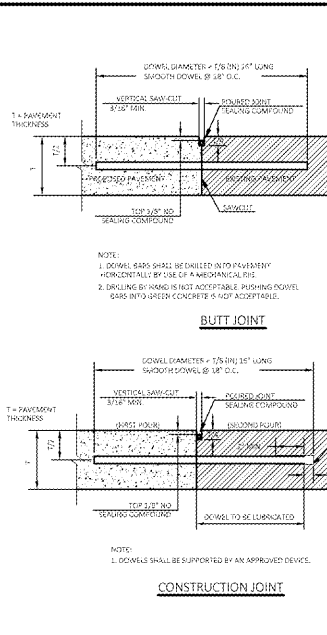
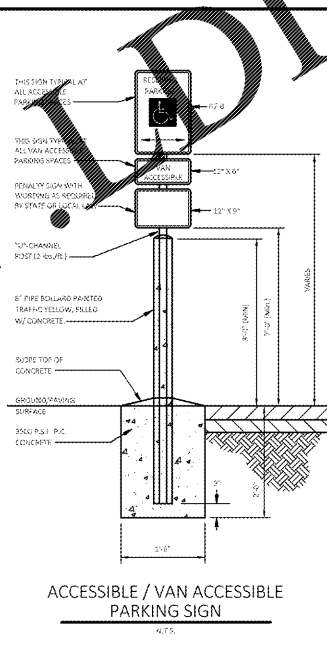
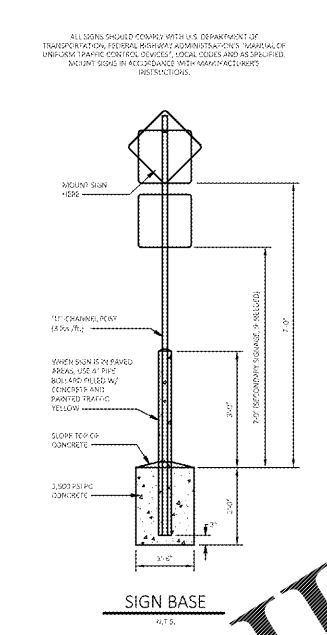
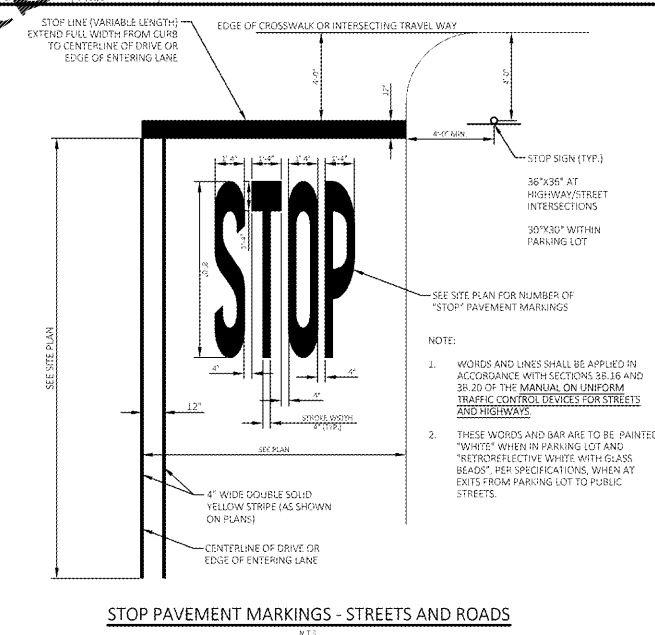
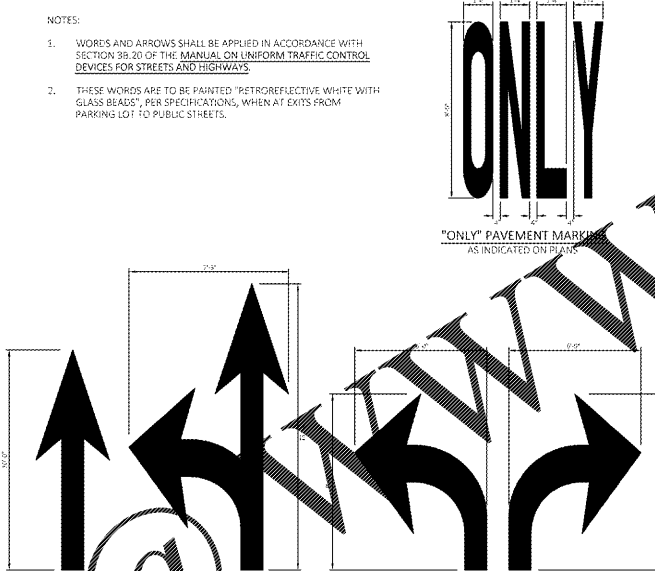

REVISIONS table with columns for NO., DATE, and DESCRIPTION.

Engineering Associates, Inc.
ENGINEERS PLANNERS SURVEYORS
LANDSCAPE ARCHITECTS ENVIRONMENTAL SCIENTISTS

DETAIL SHEET
3012 LIBERTY HWY #6
ANDRESON SOUTH CAROLINA

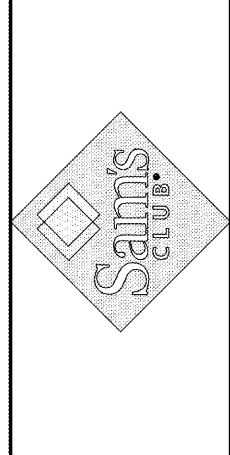

Project information table including Job No. (31076), Dwg Name (31076-07), Date (11/5/19), and Sheet No. (C7).

Order plans

Watermark: @www.dilline.com