

6/20/19 10:55 - P.R.H. MCB/CAD 19155660_001.dwg
11/17/2019
3:48:27 PM

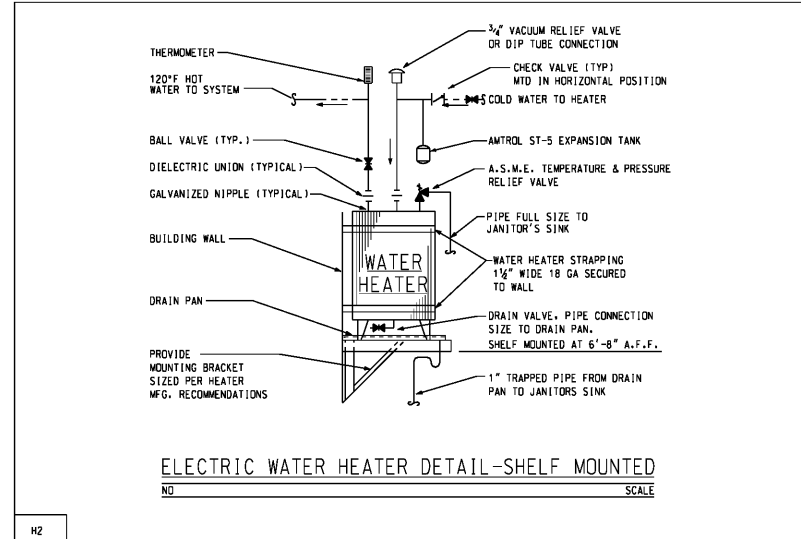

ELECTRIC WATER HEATER SCHEDULE

DESIGNATION	K.W.	VOLTAGE	NO. OF ELEMENTS	TEMP. RISE	RECOVERY G.P.H.	STORAGE CAP. (GAL.)	TANK DIA.	TANK HEIGHT	MANUFACTURER	MODEL NUMBER
WH-1 THRU 4	3	208/1/60	1	90°	12	10	16"	18"	LOCHINVAR	JRJ-010-DS



ELEVATOR PIT SUMP PUMP SCHEDULE

DESIGNATION	TYPE	G.P.W.	T.D.H.	H.P.	VOLTAGE	MANUFACTURER	MODEL NUMBER
ESP-1	OIL WINDER SUMP PUMP	150	10	2.0	208/3/60	STANCOR	SE-200 O/M

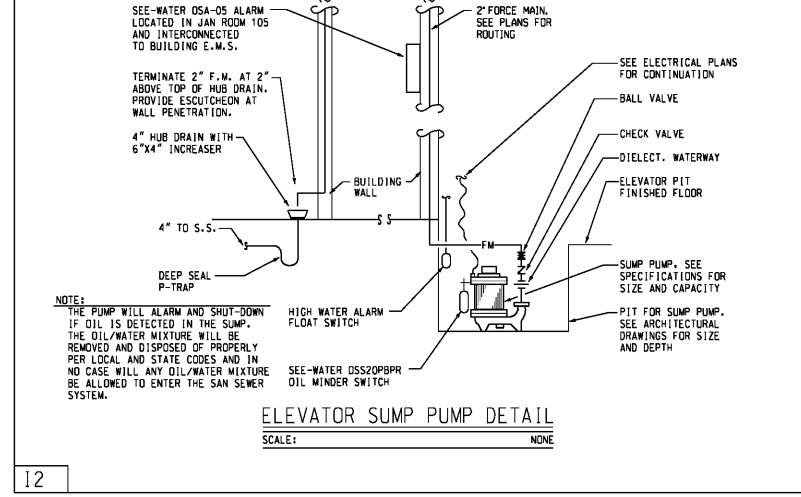

FIXTURE CONNECTION SCHEDULE

P-#	DESCRIPTION	G.W. (IN.)	H.W. (IN.)	WASTE (IN.)	VENT (IN.)
P1	H ¹ CAP WATER CLOSET (FLR.MTD.-F.V.) AMERICAN STANDARD 0355.012 LAVATORY CHURCH 9500SCT SEAT w/CHECK HINGE SLOAN ROYAL 111 FLUSH VALVE, 1.6 GPF	1	---	4	2
P2	LAVATORY (WALL HUNG) AMERICAN STANDARD 0355.012 LAVATORY SYMONS S-20 SINGLE LEVER FAUCET MCGUIRE 155WC OFF-SET GRID STRAINER w/TAIL PIECE MCGUIRE 8872 17 GA. CAST BRASS P-TRAP ZURN Z1231 LAVATORY CARRIER	1/2	1/2	1 1/4	1 1/4
P2A	LAVATORY (DUAL - UNDERMOUNT) AMERICAN STANDARD 0486.221 LAVATORY SYMONS S-240-LAM-0.5 GPM DUAL LEVER FAUCET MCGUIRE 155WC OFF-SET GRID STRAINER w/TAIL PIECE MCGUIRE 8872 17 GA. CAST BRASS P-TRAP MCGUIRE 170LK SUPPLY/STOP	1/2	1/2	1 1/4	1 1/4
P3	B1-LEVEL WALL HUNG DRINKING FOUNTAIN w/BOTTLE FILL GAS'S F08BPSL-SS B1-LEVEL D.F. W/S.S. FINISH MCGUIRE 8872 17 GA. CAST BRASS P-TRAP MCGUIRE 170LK SUPPLY/STOP	1/2	---	1 1/4	1 1/4
P4	JANITOR'S SINK (CORNER - FLOOR BASIN) STERN WILLIAMS SBC-1502-BP2 24 x 24 x 12 CORNER FLOOR SINK ZURN Z-24-SMIRC WALL FAUCET w/W.B. & V.B. HOSE CLAMP HANGER MOP HANGER	1/2	---	---	2
P5	FLOOR DRAIN (FINISHED AREA) ZURN ZN-415-Y-B-P CAST IRON BODY FLOOR DRAIN	1/2 TO 1-P.	---	AS SHOWN	AS SHOWN
P6	TRAP PRIMER VALVE w/V.P. PRECISION PLUMBING PRODUCTS, INC. MODEL "PRIME-R" w/INTEGRAL V.B..	---	---	---	---
P7	ZURN Z-137 EXPOSED, NON-PRESS. ANTIPHON. AUTOMATIC DRAINING WALL HYDRANT	3/4	---	---	---
P8	ROOF DRAIN ZURN ZC-10 1/2 EA-R CAST IRON BODY CAST IRON DOME	---	---	AS SHOWN	---
P9	HYDRANT ZURN ZC-10 1/2 EA-R CAST IRON BODY CAST IRON DOME	1	---	---	---
P10	URINAL (WALL HUNG) ZURN Z-137 EXPOSED, NON-PRESS. ANTIPHON. AUTOMATIC DRAINING WALL HYDRANT SLOAN ROYAL 186-0.5 GPF FLUSH VALVE	3/4	---	2	2

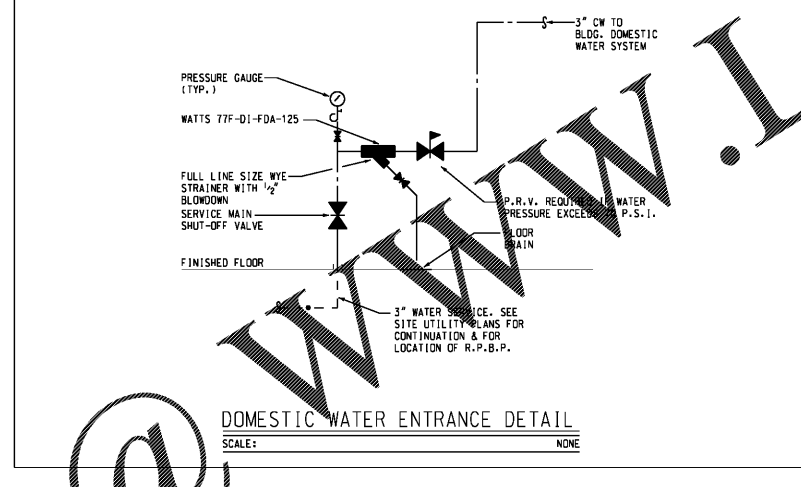
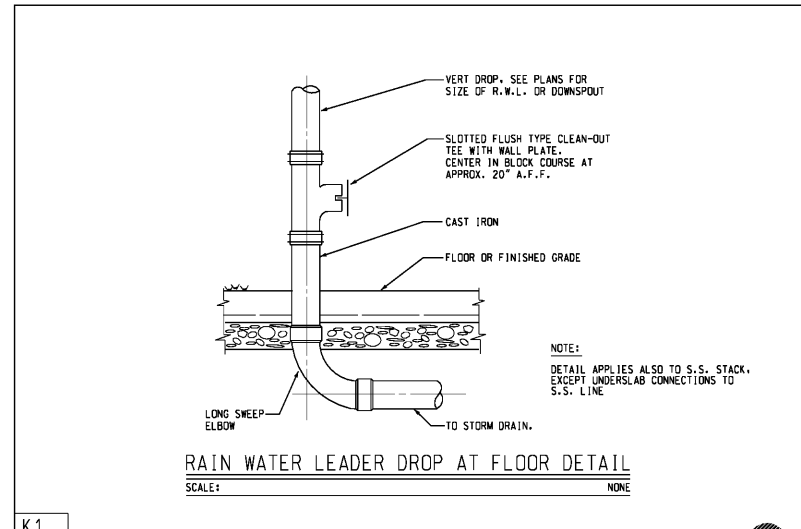
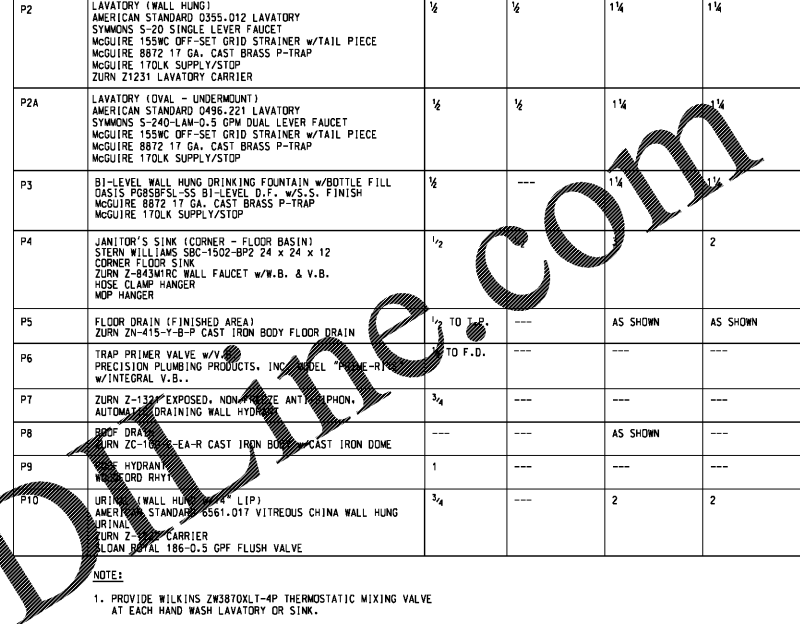

PLUMBING LEGEND

SYMBOL	DESCRIPTION	ABBREVIATIONS
●	COLD WATER (UNDERGROUND)	
○	COLD WATER	C.W.
○	HOT WATER (TEMPERATURE, IF MORE THAN ONE)	H.W.
---	SANITARY SEWER (UNDERSLAB)	
---	VENT	V
---	VENT THROUGH THE ROOF	V.T.R.
---	STORM DRAIN (UNDERSLAB)	S.D.
---	RAIN WATER LEADER	R.W.L.
---	FORCE MAIN	F.M.
---	AUTOMATIC SPRINKLER	A/S
□ P-1	FIXTURE IDENTIFICATION (SEE SPECIFICATIONS)	
○	VALVES (SEE SPECIFICATIONS FOR TYPE)	
○	AUTOMATIC SPRINKLER ENTRANCE	

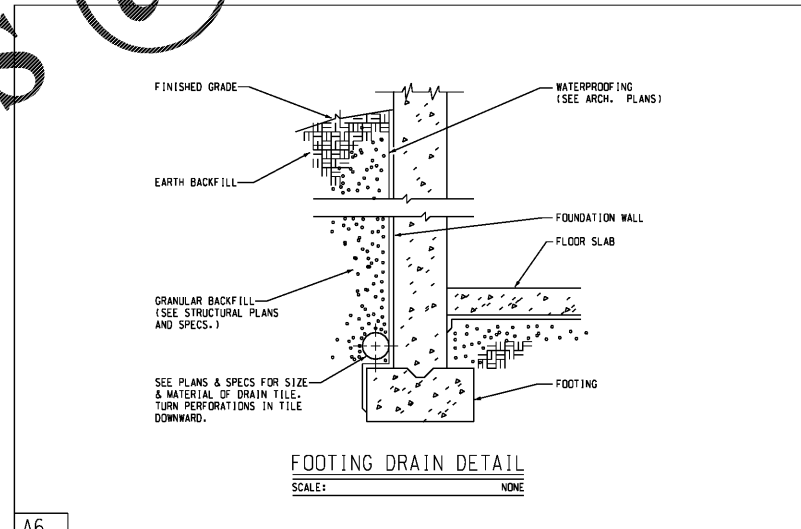
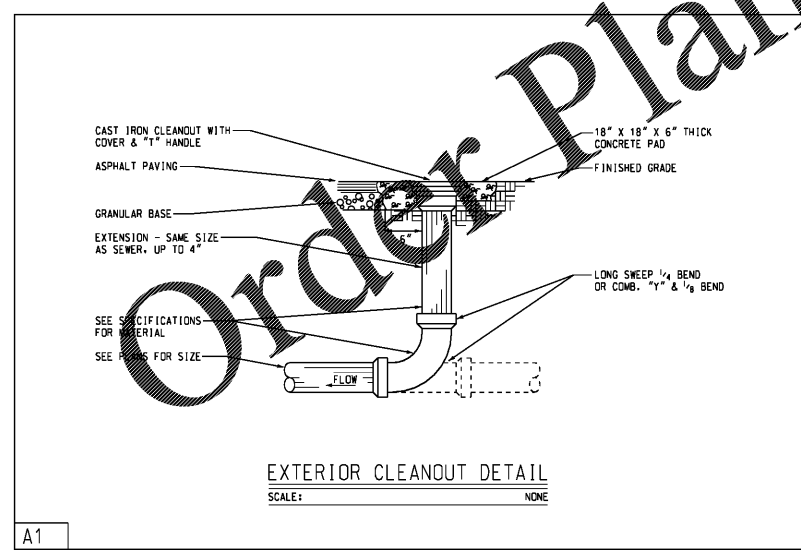

HOT WATER RECIRCULATION PUMP

DESIGNATION	TYPE	G.P.W.	T.D.H.	H.P.	VOLTAGE	MANUFACTURER	MODEL NUMBER
HWRP-1	IN-LINE BRONZE BODY	4	8	1/20	120/1/60	BELL & GOSSETT	NBF-85/LW

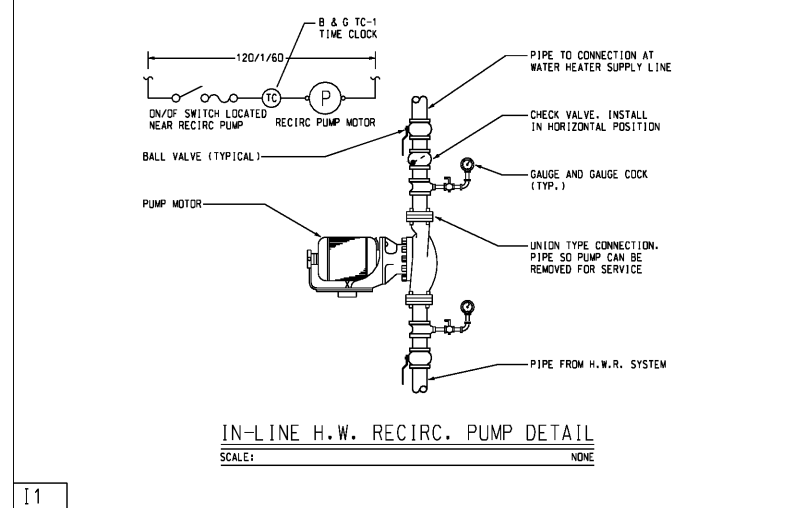

PRH
MEDICAL OFFICE BUILDING
 FLORIDA
 NAPLES,

THIS DOCUMENT CONTAINS PROPRIETARY TO DAVIS STORES INFORMATION AND/OR IT IS THE PROPERTY OF DAVIS STORES ARCHITECTS. IT IS TO BE USED ONLY FOR THE PROJECT AND SITE SPECIFICALLY IDENTIFIED HEREIN. NO PART OF THIS DOCUMENT IS TO BE REPRODUCED OR TRANSMITTED IN ANY FORM OR BY ANY MEANS, ELECTRONIC OR MECHANICAL, INCLUDING PHOTOCOPYING, RECORDING, OR BY ANY INFORMATION STORAGE AND RETRIEVAL SYSTEM.

DAVIS STORES COLLABORATIVE P.C.
DSC ARCHITECTS
 7121 CROSSROADS BVD
 888-HYWOOD, IN 37027
 TEL: (615) 726-6610
 FAX: (615) 726-6610
 EMAIL: dsc@dsca.com
 WWW: www.dsca.com

REVISIONS

NO.	DATE	DESCRIPTION

P0.01
 ISSUE DATE: 11.12.19 JOB NUMBER: 19020