



ORDERING EXAMPLE: PT-ML760-32L40T5-MDL014-SV1-FHD/ASQ-6-IEB/UJCMY

Mounting Configuration table with columns for Fixture, LED, CCT, Distribution Type, Driver, Lens, Option Control, etc.

Mounting Configuration

- List of options including CCT, Distribution Type, Driver, and Lens.

LED

LEDs: The luminaire shall use high output, high brightness LEDs...

Options: The LED driver shall be UL Recognized... Features: The luminaire shall be provided with a reflector type optic...

- Specifications: Fixture, Lens, Options, etc.



555 Lawrence Ave., Roselle, IL 60172

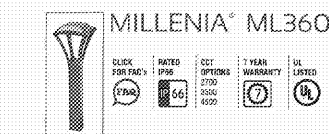

ORDERING EXAMPLE: BL8-ML360-CA-32L45T5-MDL03-PEC-FHD/UGMT

Product Specs

- Optical, Electrical, Mechanical, and other product specifications.

Performance (Based on CA Lens)

Table showing performance metrics for various fixture models.

800-621-3378 555 Lawrence Ave., Roselle, IL 60172

ML760 MILLENIA SERIES

protection, and have a DC voltage output, constant current design...

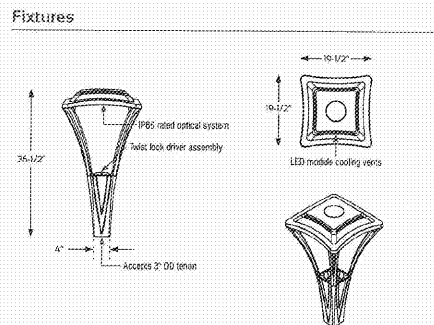

Features

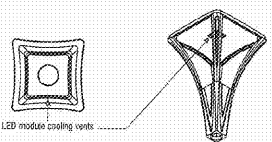

Options

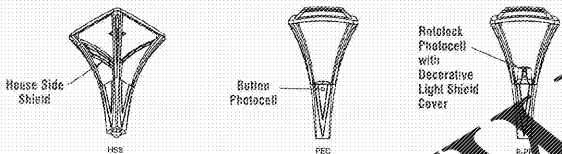

555 Lawrence Ave., Roselle, IL 60172

ML760 MILLENIA SERIES

Performance (Based on CA Lens)

Table with 15 columns showing performance data for various fixture models.



555 Lawrence Ave., Roselle, IL 60172

Product Dimensions and Features

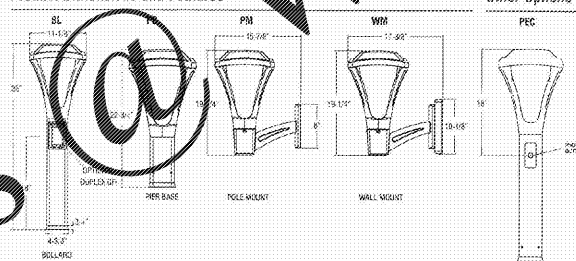

Mounting Configurations

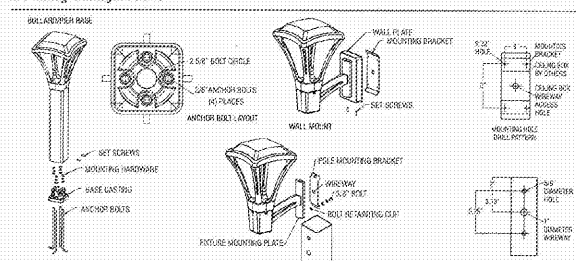

ISO Footcandle Plots

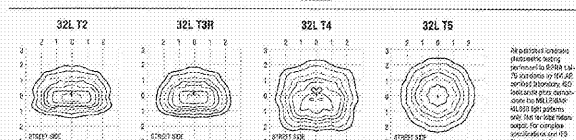

555 Lawrence Ave., Roselle, IL 60172



555 Lawrence Ave., Roselle, IL 60172



CLIENT INFORMATION table with fields for CLIENT NAME and CLIENT ADDRESS.

PROJECT INFORMATION table with fields for PROJECT NAME and PROJECT ADDRESS.

REVISIONS table with columns for No., Description, and Date.

DATE and CHECKED fields.

DATE: 20/04/14

E703