

FINISH SYMBOLS

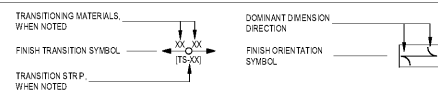

CEILING SYMBOL LEGEND

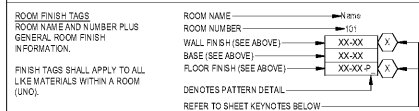
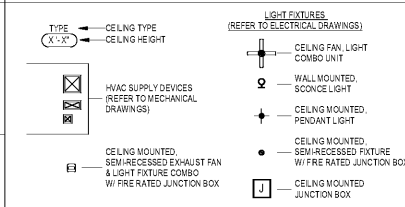

UNIT B4 DOOR SCHEDULE

TYPE	SIZE	WIDTH	HGT.	THICK.	PAIR	DOOR TYPE	DOOR MATERIAL	FRAME TYPE	FRAME MATERIAL	DOOR / FRAME FINISH	DETAIL	FIRE RATING	HARDWARE SET
A3	8'-0"	7'-0"	13'-6"			PH	WD	PTD	PH	PTD	KA-80	KA-80	
A4	2'-10"	7'-0"	13'-6"			PH	WD	PTD	PH	PTD	KA-80	KA-80	
A5	2'-10"	7'-0"	13'-6"			PH	WD	PTD	PH	PTD	KA-80	KA-80	
A8	8'-0"	7'-0"	13'-6"			PH	WD	PTD	PH	PTD	KA-80	KA-80	

12 BATHROOM 2 ELEVATION - WEST
38" x 1'-0"

10 BATHROOM 2 ELEVATION - SOUTH
38" x 1'-0"

11 BATHROOM 2 ELEVATION - EAST
38" x 1'-0"

9 BATHROOM 2 ELEVATION - NORTH
38" x 1'-0"

2 UNIT CEILING PLAN - B4 2-BEDROOM
14' x 11'-0"

8 BATHROOM ELEVATION - WEST
38" x 1'-0"

5 BATHROOM ELEVATION - NORTH
38" x 1'-0"

7 BATHROOM ELEVATION - EAST
38" x 1'-0"

4 KITCHEN ELEVATION - SOUTH
38" x 1'-0"

6 BATHROOM ELEVATION - SOUTH
38" x 1'-0"

3 KITCHEN ELEVATION - NORTH
38" x 1'-0"

1 UNIT PLAN - B4 2-BEDROOM
14' x 11'-0"

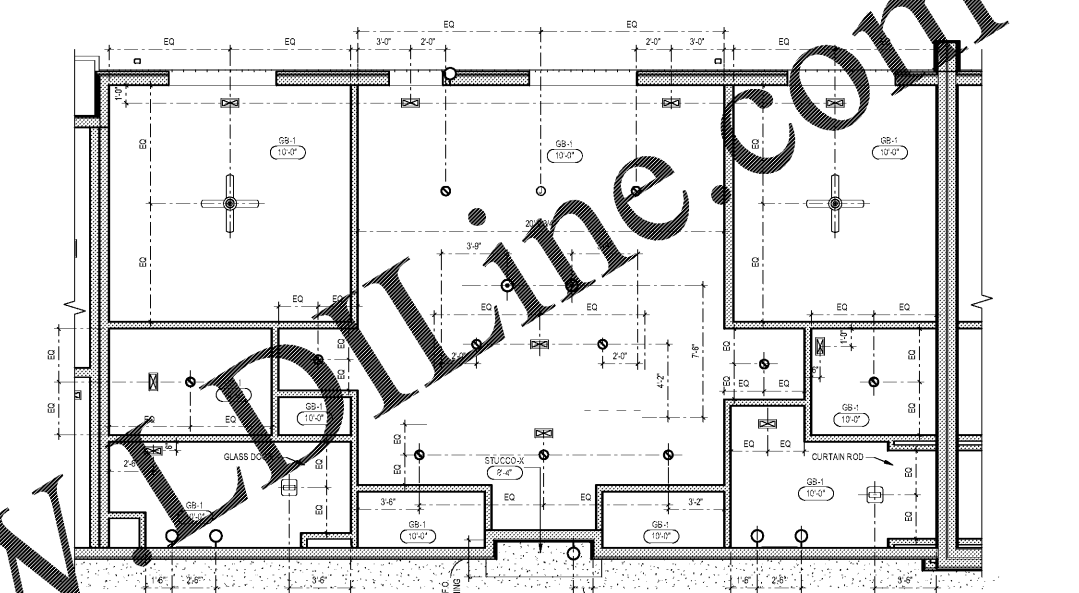
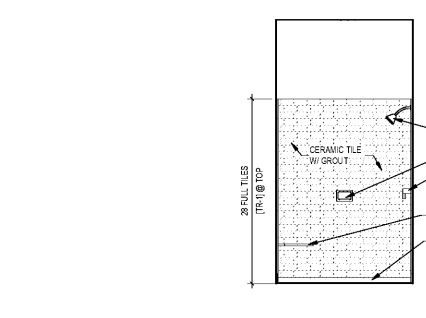
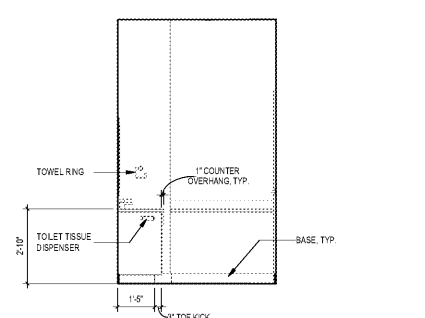
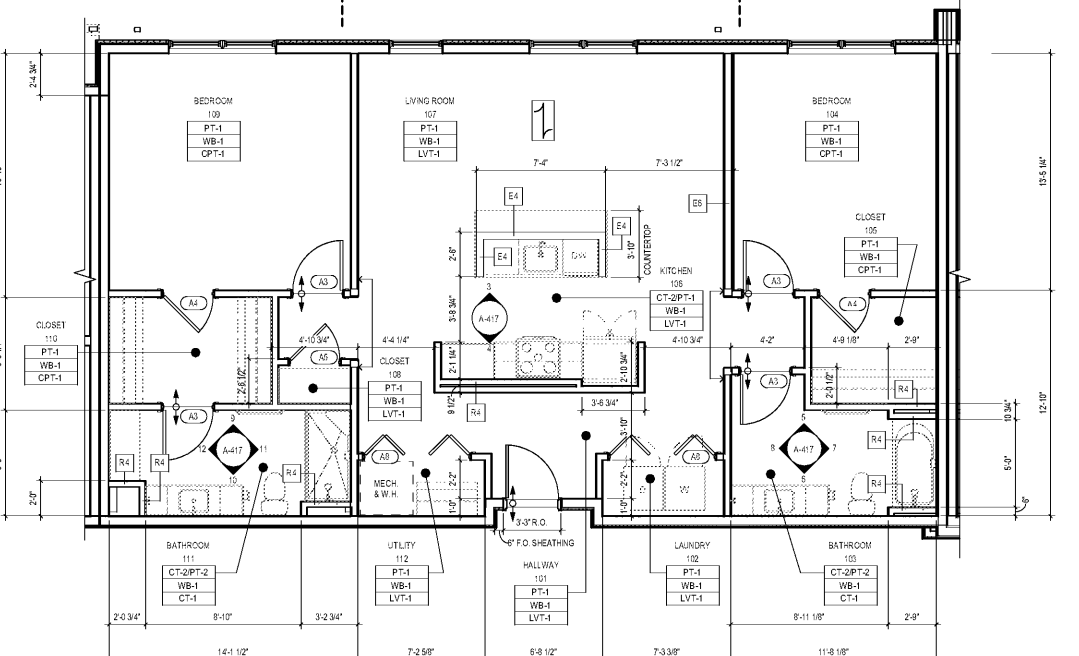
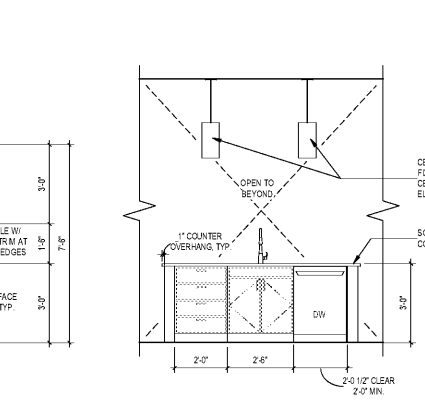
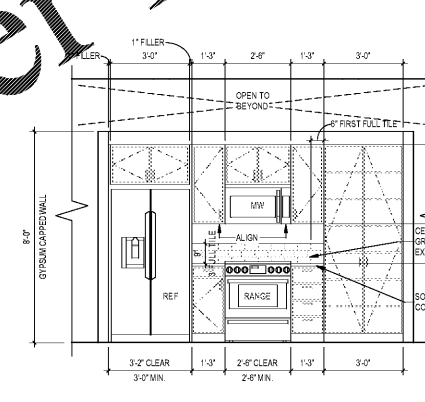
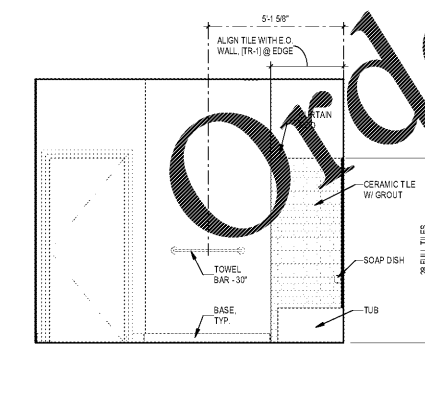
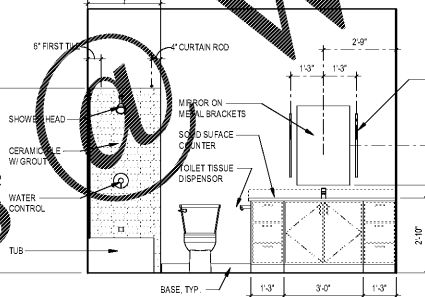
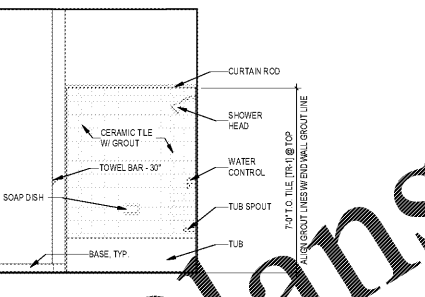
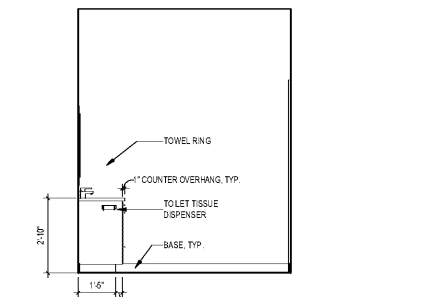

1925 Prospect Ave.
Orlando, FL 32814
P (407) 661-9100
F (407) 661-9101
www.rp.com

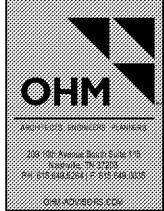

CLIENT NAME
HUTTON DEVELOPMENT
756 Cherry Street
Chattanooga, TN 37402

PROJECT NAME
ROCKLEDGE FLATS - BUILDING A
220 Barton Boulevard
Rockledge, FL 32955

No.	Description	Date

PROJECT NO. 21002
DATE 11/15/2019
DRAWN BY
CHECKED BY

GMP PRICING SET 15 NOVEMBER 2019

A-417