

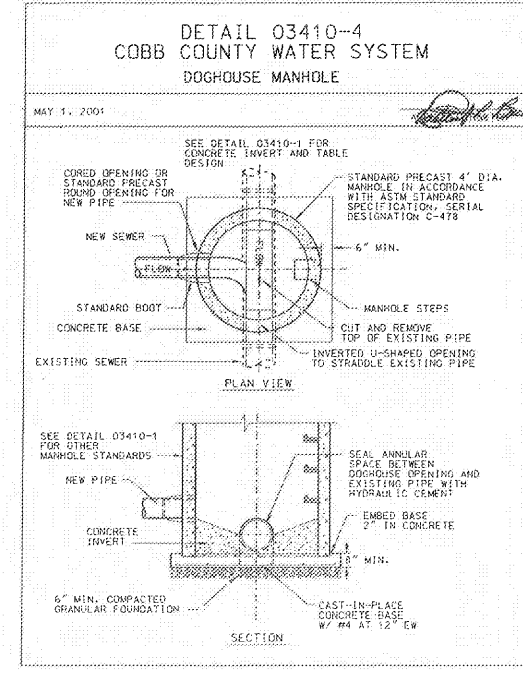

TEL 770.452.7849 FAX 770.452.0086
2951 FLOWERS RD S, SUITE 119
ATLANTA, GEORGIA 30341
WWW.EBERLY.NET

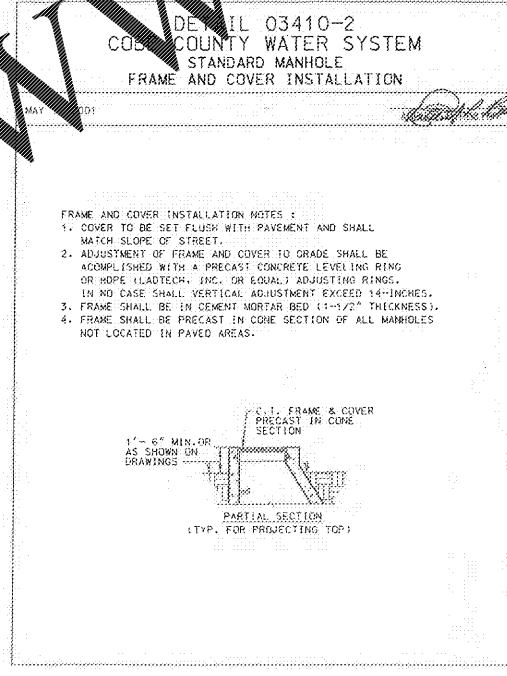

ISSUANCES		
No.	Drawing Issue Description	Date
A	ISSUE PRELIMINARY SUBMITTAL	2/16/2011
B	ISSUED FOR BID	2/16/2011

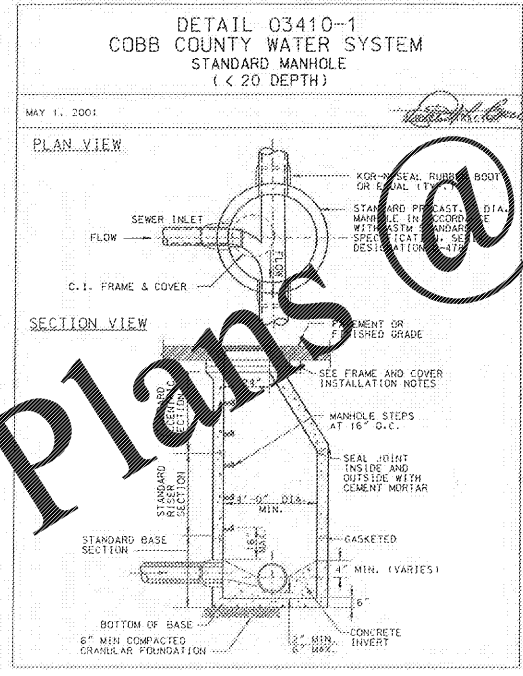
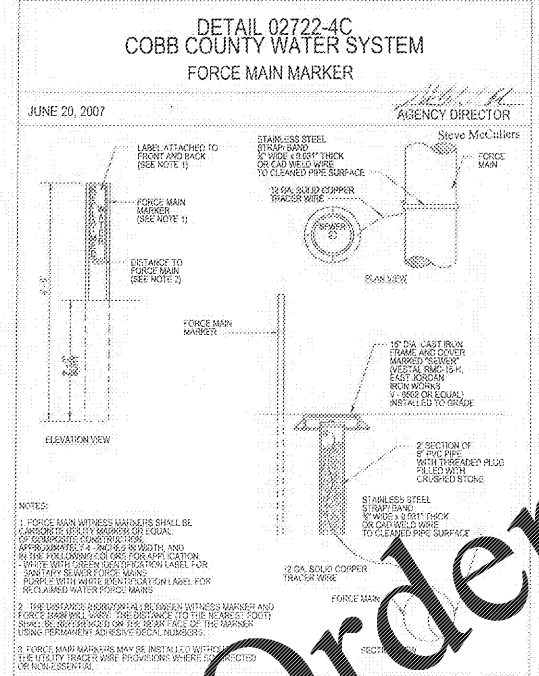
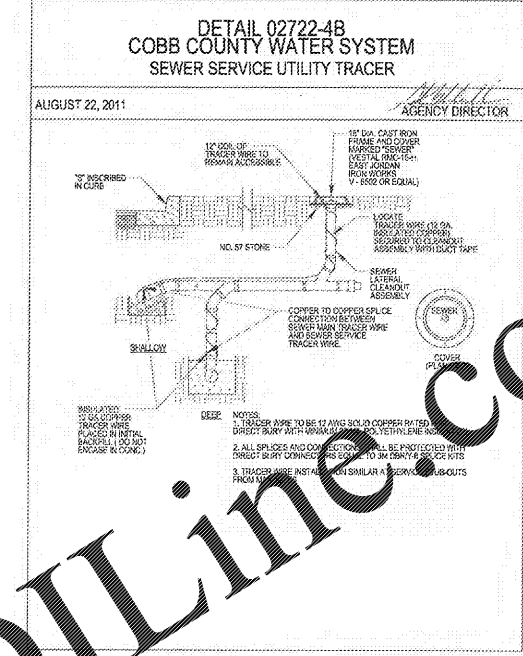
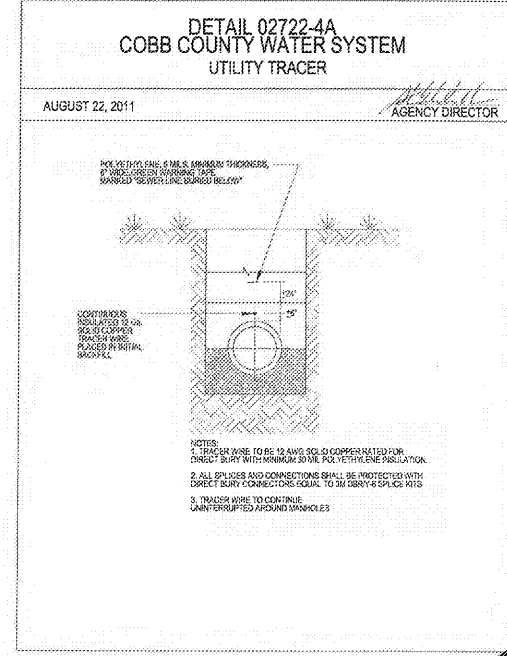
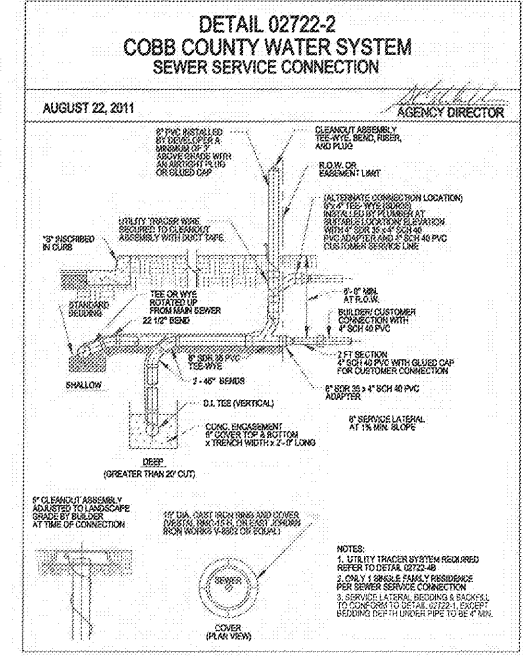
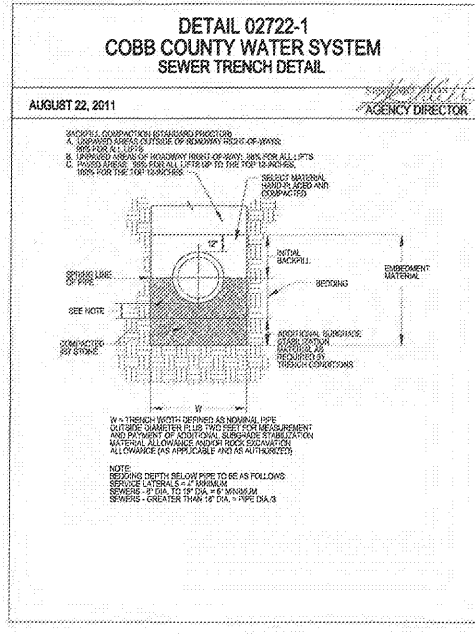

Order Plans @ www.LDILine.com

PROJECT NUMBER: 20190224.01 PROJECT NAME: PEBBLEBROOK HS B007 -
SHEET NUMBER: 03.00 - COVER
DATE: 08/08/2019, Pebblebrook B007_Fieldhouse_2019_central_detached.rvt
10/7/2019 7:48:58 AM

CALL 811
FREE THROUGHOUT
THE U.S.A.
THREE WORKING DAYS
BEFORE YOU DIG.

Know what's below.
Call before you dig.

PEBBLEBROOK HS B007 -
FIELDHOUSE
DOE Facility Code 4066
FTE = 2787
IU = 143
991 OLD ALABAMA ROAD
MABLETON, GA 30126
COBB COUNTY SCHOOL DISTRICT

CONSTRUCTION
DETAILS IV

JEREMIAH PHILLIPS	19-110.10
ANTONIO SAMPLE	10/25/2019
DYLAN LEE	
ROBERT NIEBESKI	

C7.03