

PLUMBING FIXTURE SCHEDULE						
MARK	DESCRIPTION	CONNECTIONS			RIM HEIGHT	REMARKS
		CW	HW	S/W		
WC	WATER CLOSET-TANK TYPE	1/2"	—	4"	15"	
HWC	WATER CLOSET-HANDICAPPED TANK TYPE	1/2"	—	4"	18"	19" TO TOP OF SEAT
HLAV	LAVATORY-HANDICAPPED WALL HUNG	1/2"	1/2"	1-1/4"	34"	
CTLAV	COUNTERTOP LAVATORY	1/2"	1/2"	1-1/4"	COORDINATE INSTALLATION W/ ARCH. COUNTER DETAIL	
SK-1	STAINLESS STEEL-COUNTERTOP SINK	1/2"	1/2"	1-1/2"	COORDINATE INSTALLATION W/ ARCH. COUNTER DETAIL	
LS	LAUNDRY SINK	1/2"	1/2"	1-1/2"	FREESTANDING	

SYMBOLS & ABBREVIATIONS

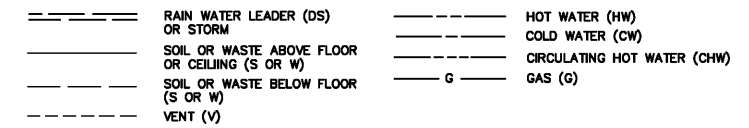

- | | | | |
|-------|-------------------------------|---------|--------------------------|
| AD | AREA DRAIN | HB | HOSE BIBB |
| AFF | ABOVE FINISHED FLOOR | HD | HUB/DR |
| AP | ACCESS PANEL | HWH | WATER HEATER |
| ARV | ACID RESISTANT VENT | HUR | HANDICAPPED URINAL |
| ARW | ACID RESISTANT WASTE | INV | INVERT |
| BV | BALL VALVE | LAV | LAVATORY |
| CHK.V | CHECK VALVE | MANHOLE | MANHOLE |
| CI | CAST IRON | MS | MEMORY STOP |
| CLG | CEILING | HLA | HANDICAPPED LAVATORY |
| CO | CLEANOUT | PRV | PRESSURE REDUCING VALVE |
| CT | COUNTER TOP | RD | ROOF DRAIN |
| DN | DOWN | RV | RELIEF VALVE |
| F.CO | FLOOR CLEANOUT | SD | SHOWER DRAIN |
| FD | FLOOR DRAIN | SH | SHOWER HEAD |
| FS | FLOOR SINK | SS | SERVICE SINK |
| DEC | DECK DRAIN | T&P | TEMPERATURE & PRESSURE |
| HEDF | HANDICAPPED DRINKING FOUNTAIN | UR | URINAL |
| EDF | ELECTRIC DRINKING FOUNTAIN | VTR | VENT THRU ROOF |
| ERD | EQUIPMENT ROOM DRAIN | WC | WATER CLOSET |
| FA | FRESH AIR | HWC | HANDICAPPED WATER CLOSET |
| FD | FLOOR DRAIN | WH | WALL HYDRANT (WATER) |
| GI | GALVANIZED IRON | YH | YARD HYDRANT (WATER) |
| GV | GATE VALVE | WHA | WATER HAMMER ARRESTOR |
| CLV | GLOBE VALVE | Y.CO | YARD CLEANOUT |
| FFD | FUNNEL FLOOR DRAIN | | |
| FCV | FLOW CONTROL VALVE | | |

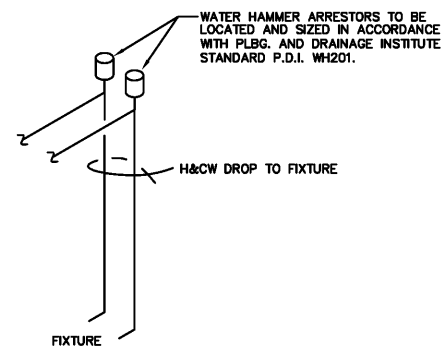

TYPICAL WATER PIPING DETAIL FOR SINGLE FIXTURE
NO SCALE

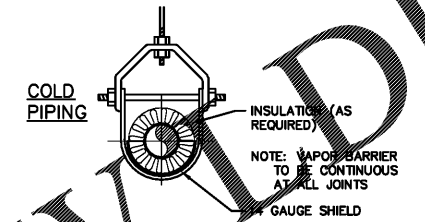
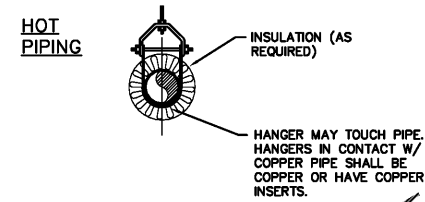

INSULATED PIPING PROTECTION DETAILS
NO SCALE

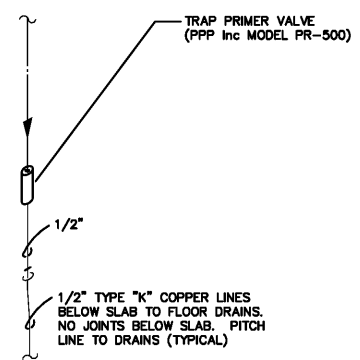

TRAP PRIMER PIPING DIAGRAM
NO SCALE

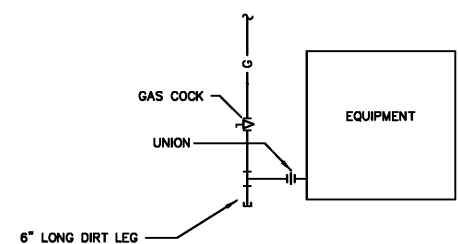

GAS CONNECTION TO EQUIPMENT
SCALE: NONE

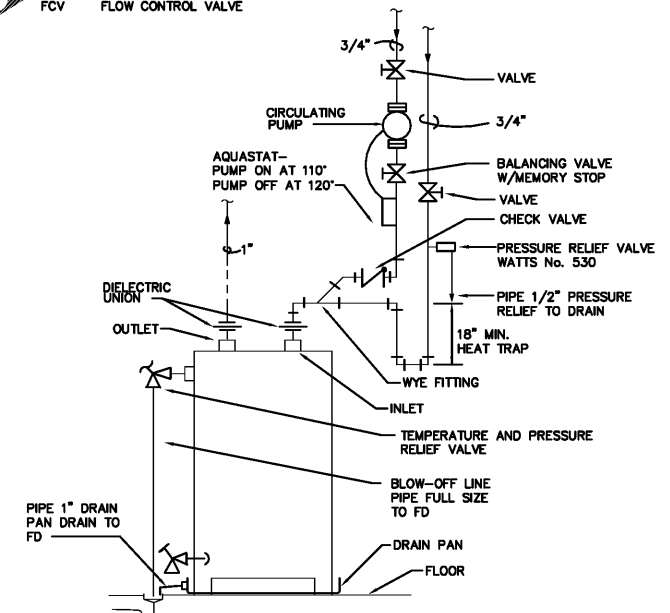

ELECTRIC WATER HEATER PIPING DIAGRAM
NO SCALE

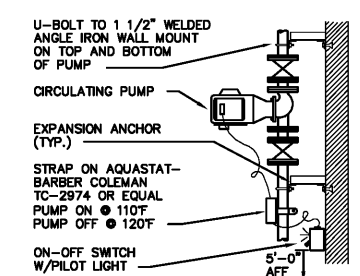

IN-LINE CIRCULATING PUMP WALL MOUNTING DETAIL
NO SCALE

Order Plans @ WWW.HLLHILL.COM

New Cornelia Branch
Southern Bank & Trust
Cornelia, Georgia
COPYRIGHT (C) 2019, H. LLOYD HILL ARCHITECTS AND ASSOCIATES, INC.

DATE	DESCRIPTION
04-09-2019	SCHEMATIC DESIGN DRAWINGS
04-30-2019	DESIGN DEVELOPMENT DRAWINGS

PROJ. NO: G1902
FILE NAME: .DWG
DRAWN BY: MR

LEGEND, SCHEDULE & DETAILS

SHEET NUMBER:
P1.0