

1/2" DIA. ALL THREAD ROD CONNECTED TO ROOF JOIST THROUGH ANOTHER HANGING ANGLE



1/2" DIA. HEAVY DUTY NUT ONE ABOVE AND ONE BELOW HANGING ANGLE

\*HOOD AND NUTS TO BE SUPPLIED BY INSTALLING CONTRACTOR HANGING ANGLE IS PRE-FINISHED AT FACTORY

**ND-2 HANGING ANGLE DETAIL**

HOOD STYLE	DIM FROM REAR	DIM FROM FRONT (24"H)	DIM FROM FRONT (30"H)
CANOPY ND2	4.166"	2.246"	2.246"
ND2-PSP-F	4.166"	2.246"	2.246"
BACKSHELF 2847BD	2.00"	14.25"	-
VHB/VHB-G	36"x36"	42"x42"	48"x48"
FRONT/BACK DIMS BY SIZE	2.246"	2.246"	2.246"

**HANGING ANGLE LOCATIONS**

EXHAUST CFM=LENGTH OF HOOD X CFM/INLET (LOAD)  
 SUPPLY CFM=EXHAUST CFM X PERCENTAGE REQUIRED  
 TOTAL DUCT AREA=144 X CFM  
 DUCT LENGTH= TOTAL DUCT AREA / DUCT DEPTH

\*CAPTIVE-AIR VENTILATOR DUCT SIZES ARE CALCULATED USING AN EXHAUST VELOCITY OF 1500-1800 FPM AND A SUPPLY VELOCITY OF 1000 FPM.

**CALCULATIONS UTILIZED**

CAPTIVE-AIR HOODS ARE BUILT IN COMPLIANCE WITH:



Listed under ETL File number 3054804-001/002

**BUILDING CODES**

CAPTIVE-AIR HOODS HAVE OPTIONAL CLEARANCE REDUCTION SYSTEMS AVAILABLE AS FOLLOWS:

MATERIAL	CLEARANCE REDUCTION SYSTEM
NON-COMBUSTIBLE	NONE REQUIRED
LIMITED-COMBUSTIBLE	3" UNINSULATED STANDOFF
COMBUSTIBLE	1" INSULATED STANDOFF

**CLEARANCE TO COMBUSTIBLES**

**INSTALLATION**

- ALL ELECTRICAL "FIELD" CONNECTIONS AND RELATED INTERCONNECTIONS BY ELECTRICAL CONTRACTORS.
- ALL PLUMBING "FIELD" CONNECTIONS AND RELATED INTERCONNECTIONS BY PLUMBING CONTRACTORS.
- HANGING BRACKETS LOCATED AND WELDED AS SHOWN ON PLANS. ALL OTHER HANGER MATERIALS PROVIDED BY INSTALLING CONTRACTORS.
- ALL CONNECTIONS FROM CAPTIVE-AIR DUCT PER MECHANICAL CONTRACTORS'S PLANS.
- COOKING EQUIPMENT TO SHUTOFF IN EVENT OF FIRE.
- EXHAUST FANS TO TURN ON IN EVENT OF FIRE.
- ALL LIGHTS FIXTURES SHOWN INSTALLED BY CAPTIVE-AIR ARE FACTORY PROVIDED. INTERCONNECTIONS BETWEEN HOODS AND TO SWITCHES BY ELECTRICAL CONTRACTORS.
- LAMPS FOR LIGHT FIXTURES BY INSTALLING CONTRACTORS.
- SEISMIC RESTRAINTS ARE RESPONSIBILITY OF INSTALLING CONTRACTOR.
- INSTALLING CONTRACTORS ASSUME ALL RELATED RESPONSIBILITY FOR VERIFICATION OF DIMENSIONAL DATA CONTAINED ON THESE DOCUMENTS FOR ACCURACY, INTEGRATION, AND ADMINISTRATION OF CODE REQUIREMENTS IN EFFECT PRIOR TO ANY RELEASE FOR PRODUCTION OF EQUIPMENT SHOWN.

**BALANCE**

- KITCHEN HOODS MUST BE BALANCED WITH KITCHEN.
- KITCHEN SHALL BE NEGATIVE WITH RESPECT TO DRINK AREA.
- RESTAURANT SHALL BE POSITIVE WITH RESPECT TO AMBIENT PRESSURE.

**ADDITIONAL**

- WRITTEN HOOD DIMENSIONS HAVE PRECEDENCE OVER SCALE.
- SCHEMATIC AND "APPROVED" COPIES OF THIS DOCUMENT MUST BE REVIEWED BY THE FACTORY PRIOR TO COMMENCEMENT OF FABRICATION.

**GENERAL NOTES**

17" Caprate Solo Filter

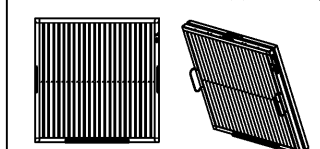
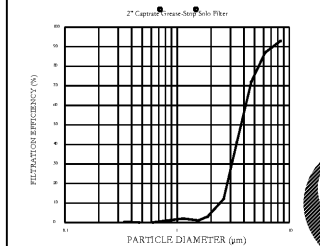

Captive Air Caprate Solo Filter  
 ETL Listed Grease Extracting Filters  
 Made From 430 Stainless Steel

**FILTER DETAIL**

**HOOD INFORMATION - Job#3803505**

HOOD NO.	TAG	MODEL	LENGTH	MAX. COOKING TEMP.	EXHAUST PLENUM RISER(S)				TOTAL SUPPLY CFM	HOOD CONSTRUCTION	HOOD CONFIG.		SWITCHES					
					TOTAL EXH. CFM	WIDTH	LENG.	HEIGHT			DIA.	CFM	VEL.	S.P.	END TO END	ROW	QUANTITY	LOCATION
1	Main	3642 BD-2-6-PLT	6' 4"	450 Deg.	950			4"	10"	950	1742	-0.710"	0	430 SS Where Exposed	LEFT	ALONE		
2	Main	3642 BD-2-6-PLT	10' 2"	450 Deg.	1525			4"	14"	1525	1427	-0.714"	0	430 SS Where Exposed	RIGHT	ALONE		
3	Dish	4224 VHB-G-ND	4' 0"	700 Deg.	600			4"	10"	600	1100	-0.090"	0	304 SS 100%	ALONE	ALONE	1 FAN	FRONT RIGHT FACE
4		96 MISC-PSP	6' 4"	300 Deg.	0					760				430 SS Where Exposed	ALONE	ALONE		
5		96 MISC-PSP	10' 2"	300 Deg.	0					1220				430 SS Where Exposed	ALONE	ALONE		

**HOOD INFORMATION**

HOOD NO.	TAG	FILTER(S)				LIGHT(S)				UTILITY CABINET(S)				FIRE SYSTEM PIPING	HOOD HANGING WGT	
		TYPE	QTY.	HEIGHT	LENGTH	EFFICIENCY @ 7 MICRONS	QTY.	TYPE	WIRE GUARD	LOCATION	SIZE	FIRE SYSTEM	SIZE			MODEL #
1	Main	Captrate Solo Filter	4	16"	16"	85% See Filter Spec.	0								YES	200 LBS
2	Main	Captrate Solo Filter	7	16"	16"	85% See Filter Spec.	0								YES	291 LBS
3	Dish						0								NO	187 LBS
4							0								NO	57 LBS
5							0								NO	77 LBS

**HOOD OPTIONS**

HOOD NO.	TAG	OPTION
1	Main	BACKSPLASH 62.00" High X 214.00" Long 430 SS Vertical RIGHT QUARTER END PANEL 18" Top Width, 0" Bottom Width, 18" High 430 SS LEFT QUARTER END PANEL 18" Top Width, 0" Bottom Width, 18" High 430 SS RISER SENSOR INSTALL 6IN PLEN GFCI DUPLEX OUTLET, 20A 125V - Hood Front Left - Vertical - Dist from End: 3.50 Dist from Bottom: 3.00
2	Main	RIGHT QUARTER END PANEL 18" Top Width, 0" Bottom Width, 18" High 430 SS LEFT QUARTER END PANEL 18" Top Width, 0" Bottom Width, 18" High 430 SS RISER SENSOR INSTALL 6IN PLEN GFCI DUPLEX OUTLET, 20A 125V - Hood Front Right - Vertical - Dist from End: 3.50 Dist from Bottom: 3.00 GFCI DUPLEX OUTLET, 20A 125V - Hood Front Left - Vertical - Dist from End: 3.50 Dist from Bottom: 3.00
3	Dish	FIELD WRAPPER 17.00" High Front, Left, Right

**PERFORATED SUPPLY PLENUM(S)**

HOOD NO.	TAG	POS.	LENGTH	WIDTH	HEIGHT	TYPE	RISER(S)				
							WIDTH	LENG.	DIA.	CFM	S.P.
4		Front	76"	9"	6"	MUA	6"	28"		380	0.118"
						MUA	6"	28"		380	0.118"
						MUA	6"	28"		406	0.133"
						MUA	6"	28"		406	0.133"

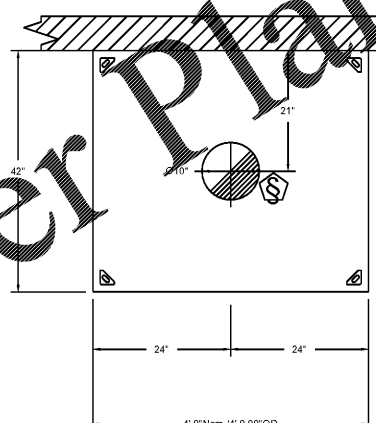

PLAN VIEW - Hood #3 (Dish)  
 4' 0.00" LONG 4224VHB-G-ND

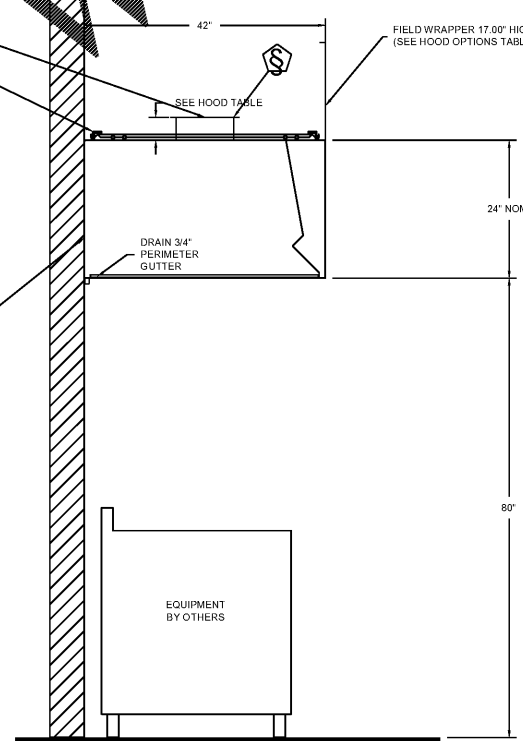

SECTION VIEW - MODEL 4224VHB-G-ND  
 HOOD - #3 (Dish)

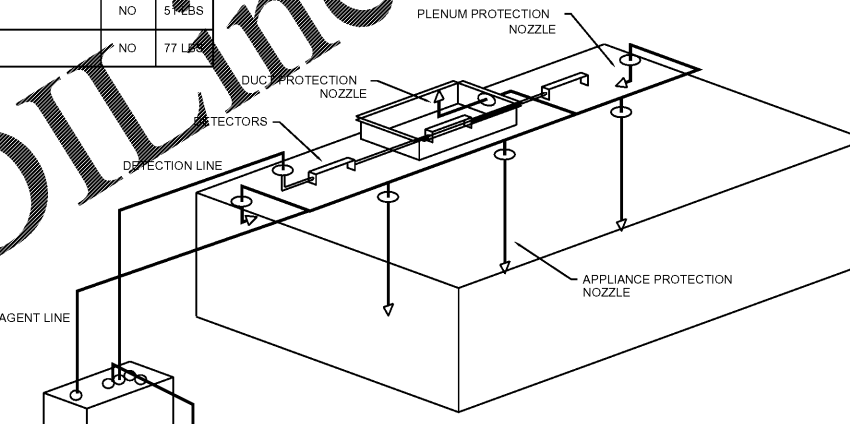

TYPICAL ANSUL R102 SYSTEM LAYOUT WITH REMOTE MOUNTED AUTOMAN

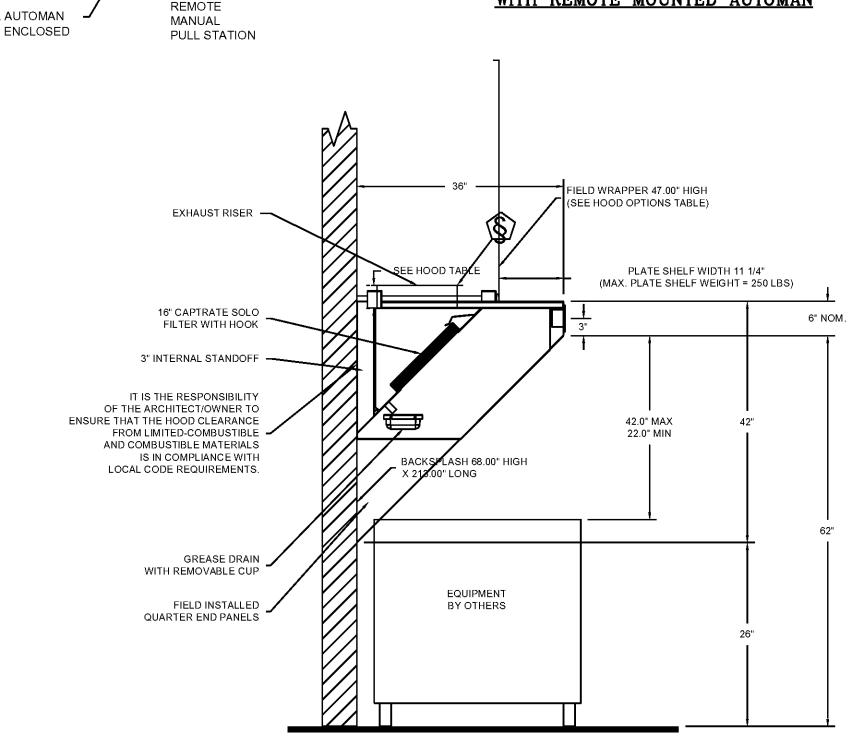

SECTION VIEW - MODEL 3642BD-2-6-PLT  
 HOOD - #1 (Main)

**HOOD PLANS, ELEVATIONS AND SCHEDULE**

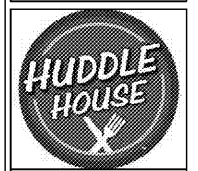

JOB NO. LI908

**NORWOOD ARCHITECTS**  
 807 Corporate Blvd. NW  
 Atlanta, Georgia 30318  
 ph. 678-921-0302 fax. 678-921-0301  
 www.norwoodarchitects.com

**HUDDLE HOUSE**  
 EVO 2000 RESTAURANT  
 US HWY 43 RUSSELLVILLE, AL  
 FRANKLIN CO. 35653

NO.	ISSUE DATE
	PERMIT SET / 2019

DRAWING NUMBER

**MH100**