

A

B

C

D

E

F

VA FORM 08-6231 1 2 3 4 5 6 7 8 9 10

QTY/RM	JSN #	AI	DESCRIPTION
STAFF LOUNGE			
1	A1010	C/C	TELECOMMUNICATION OUTLET-SEE PLAN
1	A1012	V/C	TELEPHONE, DESK, MULTIPLE LINE
1	A1080	V/C	MIRROR, POSTURE, WALL MOUNTED
1	A5075	V/C	DISPENSER, SOAP, DISPOSABLE
1	A5080	V/C	DISPENSER, PAPER TOWEL, SS, SURFACE MOUNTED
1	A5145	C/C	HOOK, GARMENT, DOUBLE, SS, SURFACE MOUNTED
1	A5210	C/C	BRACKET, TELEVISION, WALL MOUNTED, W/ADJUST ARM
1	A5220	C/C	BRACKET, TELEVISION, WALL BACKING
1	F3065	V/V	WHITEBOARD, BULLETIN BOARD COMBINATION
3	F0220	V/V	CHAIR, DINING ROOM
1	F0765	V/V	TABLE, DINING
1	F2015	V/V	BASKET, WASTE/PAPER/METAL/PLASTIC, 2 SWINGING DOORS
1	CS010	C/C	SINK, SS, SINGLE COMPARTMENT, 7.5x12x12D
1	C1020	C/C	COUNTERTOP, SOLID SURFACE
1	F3200	V/V	CLOCK, BATTERY, 12" DIAMETER
1	M0515	V/V	TELEVISION, HD 1080 LED 43" CLASS
1	R7250	C/C	REFRIGERATOR/FREEZER, 24 CUBIC FEET
1	K4665	V/V	BUILD IN MICROWAVE
1	K1552	V/V	BREWER, COFFEE, AUTO, ELEC, 3 BURNER FRONT/BACK

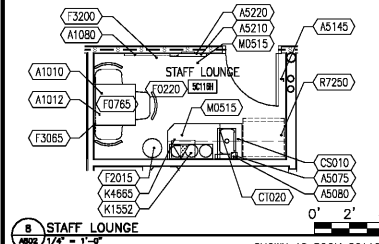

1 STAFF LOUNGE
A002 1/4" = 1'-0"
SHOWN AS ROOM 5C116H

QTY/RM	JSN #	AI	DESCRIPTION
ISOLATION / SECLUSION ROOM - SINGLE BEDROOM			
1	A6025	C/C	MIRROR, SAFETY, CONVEX
1	M7011	V/V	BED, PLATFORM WITHOUT VISIBLE LEGS, PSYCHIATRY 75"x30"x16"H
1		C/C	PADDED SURFACE
1		C/C	CUSHIONED FLOOR
1		C/C	CEILING WALL ART
1		C/C	VIDEO RECORDER WITH REMOTE CAPABILITY
1		C/C	INTERCOM
ANTEROOM, ISOLATION / SECLUSION ROOM			
1	A1085	C/C	MIRROR, SS, WITH SS FRAME, 36x18
1	A5077	V/C	BEHAVIORAL HEALTH DISPENSER HAND SANITIZER
1		C/C	RECESSED GLOVE HOLDER
1		C/C	RECESSED IN WALL CABINET (FOR CLOTHES AND LITERATURE)
1		C/C	HAND WASHER DRYER
1	P9160	C/C	LAVATORY, CHINA, FOR DISTURBED PATIENT
TOILET/SHOWER, PATIENT @ SINGLE BEDROOM			
1	A1085	C/C	MIRROR, SAFETY, PSYCHIATRIC
1	A5110	C/C	GRAB BAR, PSYCHIATRIC
1	A5111	C/C	GRAB BAR, PSYCHIATRIC
1	A5112	C/C	GRAB BAR, PSYCHIATRIC
1	A5200	C/C	DISPENSER, TOILET TISSUE, PSYCHIATRIC
1	F2000	V/V	COLLAPSIBLE WASTE RECEPTACLE
1		C/C	SHOWER, PATIENT, PSYCHIATRIC
1	P9160	C/C	LAVATORY, CHINA, FOR DISTURBED PATIENT
1	P9400	C/C	TOILET, SIPHON YETI, PSYCHIATRIC
1		C/C	CURTAIN TRACK, RECESSED
1		C/C	CURTAIN-SHOWER (BREATHABLE WITH COLLAPSIBLE HOOKS)

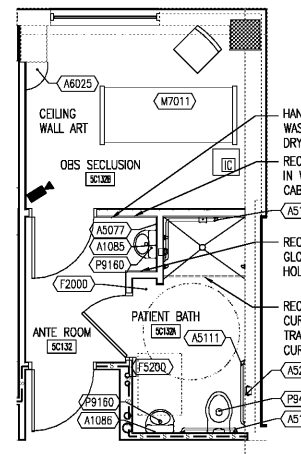

2 PATIENT ROOM SECLUSION - BRNP5
A002 1/4" = 1'-0"
SHOWN AS ROOM 5C132 W/ BATHROOM 5C132A ANTEROOM 5C132C SIM 5C148

# of RMs	QTY/RM	JSN #	AI	DESCRIPTION	TOTAL QTY
2	1	A1010	C/C	TELECOMMUNICATION OUTLET	2
2	1	A1012	V/C	TELEPHONE, WALL MOUNTED, 1 LINE	2
2	1	A5075	V/C	DISPENSER, SOAP, DISPOSABLE	2
2	1	A5080	V/C	DISPENSER, PAPER TOWEL, SURFACE MOUNTED	2
2	1	C0200	C/C	CABINET, U/C/B, 1 SHELF, 1 DRAWER, 1 DO, 36X24X22	2
2	1	C0200	C/C	CABINET, U/C/B, 4 DRAWER, 2 DO, 36X24X22	2
2	1	CB020	C/C	CABINET, W/H, 2 SHELF, 1 DO, 38X24X13	2
2	2	C1030	C/C	COUNTERTOP, HIGH PRESSURE LAMINATE	4
2	1	F2010	V/V	BASKET, WASTE/PAPER, STEP-ON	2
2	1	C1030	C/C	COUNTERTOP, HIGH PRESSURE LAMINATE	2
2	1	F3025	V/V	BOARD, BULLETIN, WOOD FRAMED	2
2	1	K1552	V/V	BREWER, COFFEE, AUTO, ELECTRIC, 3 BURNER, FRONT/BACK	2
2	1	K4665	V/V	MICROWAVE	2
2	1	K4650	V/V	ICE MAKER/WATER WITH DISPENSER	2
2	1	K7250	V/V	REFRIGERATOR, U/C or F/SS, 5 Cu.Ft.	2

3 NOURISHMENT ROOM - NCWD1
A002 1/4" = 1'-0"
SHOWN AS MED ROOM 5C-120B W/ MIRROR AND MATCHING 5C157B ALL KEYNOTES APPLY

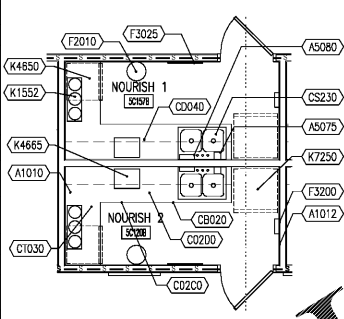

QTY/RM	JSN #	AI	DESCRIPTION
NURSE STATION			
5	A1010	C/C	TELECOMMUNICATION OUTLET-SEE PLAN
5	A1015	V/C	TELEPHONE, DESK, MULTIPLE LINE
5	E0418	C/C	NURSE STATION, MEDIUM, FREE STANDING, ERGONOMICS.
5	F0280	V/V	CHAIR, SWIVEL, LOW BACK
1	F2000	V/V	BASKET, WASTE/PAPER, FIRE RESISTANT
1	F3050	V/V	WHITEBOARD, DRY ERASE
1	F2540	V/V	SHREDDER, PAPER, SECURITY, 27"
1	F3200	V/V	CLOCK, BATTERY, 12" DIAMETER

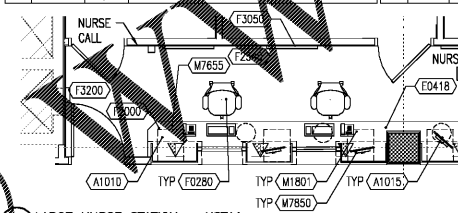

4 LARGE NURSE STATION - NSTA1
A002 1/4" = 1'-0"
SHOWN AS ROOM 5C120 SIM AND MIRRORRED AT 5C157

QTY/RM	JSN #	AI	DESCRIPTION
GERIATRIC DAY ROOM			
1	A1010	C/C	TELECOMMUNICATION OUTLET
1	AS210	C/C	CUSTOM TELEVISION AND DVD/DVR, SPACE MOUNTED BOX, PSYCHIATRY
1	AS220	C/C	BRACKET, TELEVISION, WALL BACKING
1	A6046	V/V	ARTWORK, DECORATIVE, WITH FRAME
1	F0725	V/V	TABLE, OCCASIONAL
1	F0220	V/V	CHAIR, SIDE WITH ARMS, PSYCH.
1	F2000	V/V	BASKET, WASTE/PAPER, FIRE RESISTANT BRGE
1	F3010	V/V	BOARD, BULLETIN 48X48, PSYCH
1	F3200	V/V	CLOCK, BATTERY, 12" DIAMETER
0	M0510	V/V	TV/DVD COMBINATION
1	M0515	V/V	TELEVISION, HD 1080 LED 55" CLASS
		C/C	ON CALL/PANIC BUTTON

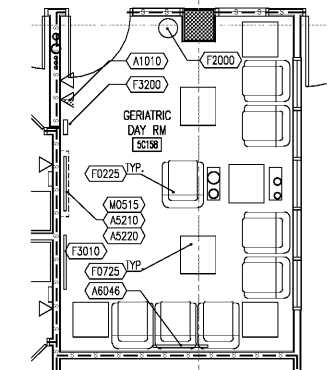

5 DAY ROOM (DAYR1)
A002 1/4" = 1'-0"
SHOWN AS GERIATRIC DAY ROOM 5C158

QTY/RM	JSN #	AI	DESCRIPTION
CONSULT ROOM / EXAM ROOM			
1	A1010	C/C	TELECOMMUNICATION OUTLET-SEE PLAN
1	A1015	V/C	TELEPHONE, DESK, MULTIPLE LINE
2	A1132	C/C	RAIL, ACCESSORY MOUNTING, LENGTH AS REQUIRED
1	A5077	V/C	BEHAVIORAL HEALTH, DISPENSER HAND SANITIZER
1	A5080	V/C	DISPENSER, PAPER TOWEL, SS, SURFACE MOUNTED PSYCH
1	A5107	V/C	DISPENSER, GLOVE, SURGICAL/EXAMINATION, WALL MOUNTED
1	CD040	C/C	CABINET, W/H, 2 SHELF, PSYCHIATRIC
1	C1030	C/C	COUNTERTOP, SOLID SURFACE
1	E0123	V/V	HEAVY DUTY TABLE
1	F2000	V/V	COLLAPSIBLE WASTE RECEPTACLE
1	F3200	V/V	CLOCK, 12" DIA, BATTERY
1	F0205	V/V	CHAIR, WITH SIDE ARMS, PSYCH
1	M1801	V/V	COMPUTER, MICROPROCESSING, W/ DUAL FLAT PANEL MONITORS
1	M1802	V/V	WORK STATION, COMPUTER, RETRACTABLE, WALL MNTD
1	M3072	V/V	FRAME, INFECTIOUS WASTE BAG W/LID
1	M4100	V/V	SPHYGMOMANOMETER, ANEROID, WALL MTD
1	M4200	V/V	OTOSCOPE / OPHTHALMOSCOPE
1	M7401	V/V	LIGHT, EXAM, MOBILE, SPOTLIGHT, MOBILE STAND
1	M9025	V/V	TABLE EXAMINATION/TREATMENT W/ CABINET
1	P9160	C/C	LAVATORY, CHINA, FOR DISTURBED PATIENT
		C/C	ON CALL/PANIC BOTTOM

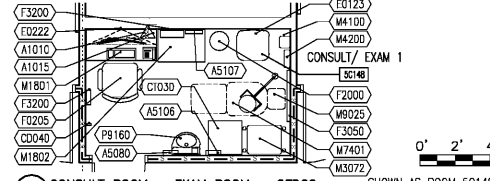

6 CONSULT ROOM - EXAM ROOM - OFDC2
A002 1/4" = 1'-0"
SHOWN AS ROOM 5C148 SIM AT 5C102, 5C119 AND 5C154

QTY/RM	JSN #	AI	DESCRIPTION
STAFF TOILET / SHOWER			
1	A1090	C/C	MIRROR, FLOAT GLASS, WITH SS FRAME & SHELF
1	A5030	C/C	BENCH, STALL, SHOWER, BUILT IN
1	A5075	C/C	DISPENSER, SOAP, DISPOSABLE
1	A5082	C/C	DISPENSER, PAPER TOWEL, SENSOR, HANDS FREE
1	A5090	C/C	DISPOSAL, SANITARY NAPKIN, SS, SURFACE MOUNTED
1		V/V	NAPKIN/TAMPON VENDING MACHINE
1	A5110	C/C	GRAB BAR, 1-1/4" DIA., SS, 2 WALL, SHOWER USE
1	A5111	C/C	GRAB BAR, 1-1/4" DIA., SS, WALL MTD
1	A5145	C/C	HOOK, GARMENT, DOUBLE, SS, SURFACE MOUNTED
1	A5170	C/C	ROD, SHOWER CURTAIN, 17DIA, /CURTAIN AND HOOKS
1	A5200	C/C	DISPENSER, TOILET TISSUE, 2-ROLL, SURFACE MOUNTED
1		C/C	BAR, MOUNTED, 12" DIAMETER, SS, SURFACE MOUNTED
1	F2010	V/V	BASKET, WASTE/PAPER, STEP-ON
1	P3000	C/C	LAVATORY, VITREOUS CHINA, STRAIGHT BACK
1	P5010	C/C	SHOWER, SINGLE, HAND-HELD
1	P9050	C/C	TOILET, WALL HUNG, SIPHON JET

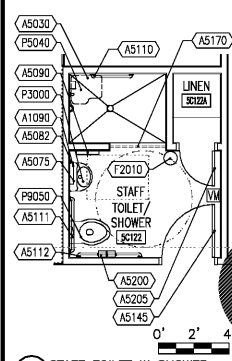

7 STAFF TOILET W SHOWER
A002 1/4" = 1'-0"
SHOWN AS STAFF TOILET 5C122

QTY/RM	JSN #	AI	DESCRIPTION
SOILED UTILITY ROOM			
1	A5075	V/C	DISPENSER, SOAP, DISPOSABLE
1	A5080	V/C	DISPENSER, PAPER TOWEL, SS, SURFACE MOUNTED
1	A5107	V/C	DISPENSER, GLOVE, SURGICAL/EXAMINATION, WALL MTD
1	C1050	C/C	COUNTERTOP, STAINLESS STEEL
1	F0530	C/C	CART, TRASH
1	F0530	C/C	CART, TRASH MEDICAL WAST, 6GAL (32"x24.25"x25"H)
1	F2020	C/C	BASKET, WASTE/PAPER, STEP-ON
1	M3072	V/V	FRAME, INFECTIOUS WASTE BAG W/ LID
1	P6350	V/V	LAVATORY, CHINA
1	P2000	V/V	EYEWASH, WALL MOUNTED, HANDS FREE
1	P2451	V/V	VALVE, MIXING, THERMOSTATIC, EYEWASH
1	P3100	V/V	LAVATORY, VITREOUS CHINA, SLAB TYPE.

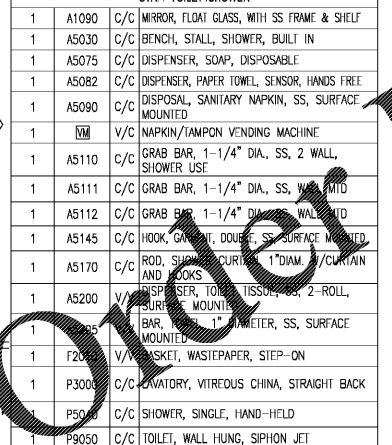

8 SOILED UTILITY AND LINEN ROOM
A002 1/4" = 1'-0"

QTY/RM	JSN #	AI	DESCRIPTION
DINING ROOM			
1	A1010	C/C	TELECOMMUNICATION OUTLET
1	A1012	V/C	TELEPHONE, WALL, 1 LINE
1	A5075	V/C	DISPENSER, SOAP, DISPOSABLE
1	A5077	V/C	BEHAVIORAL HEALTH DISPENSER HAND SANITIZER
1	A5082	C/C	DISPENSER, PAPER TOWEL, SENSOR, HANDS FREE
1	AS210	C/C	CUSTOM 55" TELEVISION AND DVD/DVR, SURFACE WALL MOUNTED BOX, PSYCHIATRY
1	AS220	C/C	TELEVISION, WALL BACKING
4	A6046	V/V	ARTWORK, DECORATIVE WITH FRAME, PSYCHIATRY
1	C0200	C/C	CABINET, U/C/B, 1 SHELF, 1 DRAWER, 1 DO, 36x24x22
1	C0200	C/C	CABINET, U/C/B, 4 DRAWER, 36x24x22
1	CO4PO	C/C	CABINET, SINK, U/C/B, 2 DOOR, 36x36x22
3	CB020	C/C	CABINET, W/H, 2 SHELF, 1 DO, SLOPING TOP, 38x24x13
1	CS010	C/C	SINK, SS, SINGLE COMPARTMENT, 7.5x12x12D
1	C1020	C/C	COUNTERTOP, SOLID SURFACE
24	F0210	V/V	CHAIR, SIDE, WITH ARMS
6	F0795	V/V	TABLE, DINNING
2	F2000	V/V	BASKET, WASTE/PAPER, STEP-ON, 23 GAL.
1	F3200	V/V	CLOCK, BATTERY, 12" DIAMETER
1	M0515	V/V	TELEVISION, HD 1080P LED 55" CLASS
1	R4650	V/V	ICE MAKER/WATER WITH DISPENSER
1		V/V	JUICE MACHINE SYSTEM
1		V/V	COFFEE SYSTEM
1		C/C	ON CALL/PANIC BOTTOM

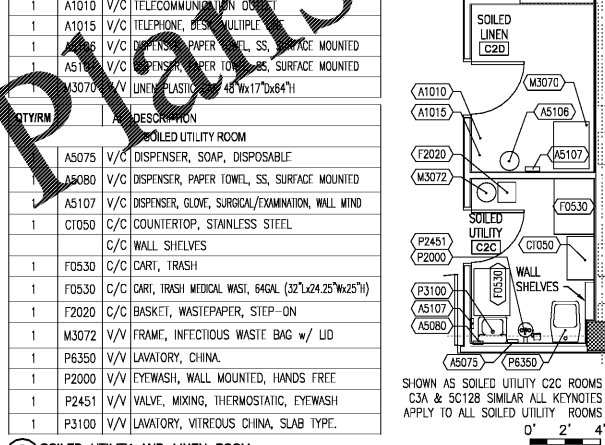

9 DINING ROOM - FSCD1 WITH NCWD1
A002 1/4" = 1'-0"
SHOWN AS SOILED UTILITY C2D ROOMS C3B & C372C SIMILAR ALL KEYNOTES APPLY TO ALL SOILED UTILITY ROOMS

QTY/RM	JSN #	AI	DESCRIPTION
GERIATRIC DINING ROOM			
1	A1010	C/C	TELECOMMUNICATION OUTLET
1	A1012	V/C	TELEPHONE, WALL, 1 LINE
1	A5075	V/C	DISPENSER, SOAP, DISPOSABLE
1	A5077	V/C	BEHAVIORAL HEALTH DISPENSER HAND SANITIZER
1	A5082	C/C	DISPENSER, PAPER TOWEL, SENSOR, HANDS FREE
1	AS210	C/C	CUSTOM 55" TELEVISION AND DVD/DVR, SURFACE WALL MOUNTED BOX, PSYCHIATRY
1	AS220	C/C	TELEVISION, WALL BACKING
1	A6046	V/V	ARTWORK, DECORATIVE WITH FRAME, PSYCHIATRY
1	C0200	C/C	CABINET, U/C/B, 1 SHELF, 1 DRAWER, 1 DO, 36x24x22
1	CO200	C/C	CABINET, U/C/B, 4 DRAWER, 36x24x22
1	CO4PO	C/C	CABINET, SINK, U/C/B, 2 DOOR, 36x36x22
3	CB020	C/C	CABINET, W/H, 2 SHELF, 1 DO, SLOPING TOP, 38x24x13
1	CS010	C/C	SINK, SS, SINGLE COMPARTMENT, 7.5x12x12D
1	C1020	C/C	COUNTERTOP, SOLID SURFACE
24	F0210	V/V	CHAIR, SIDE, WITH ARMS
6	F0795	V/V	TABLE, DINNING
2	F2000	V/V	BASKET, WASTE/PAPER, STEP-ON, 23 GAL.
1	F3200	V/V	CLOCK, BATTERY, 12" DIAMETER
1	M0515	V/V	TELEVISION, HD 1080P LED 55" CLASS
1	R4650	V/V	ICE MAKER/WATER WITH DISPENSER
1		V/V	JUICE MACHINE SYSTEM
1		V/V	COFFEE SYSTEM
1		C/C	ON CALL/PANIC BOTTOM

