

BALCONY

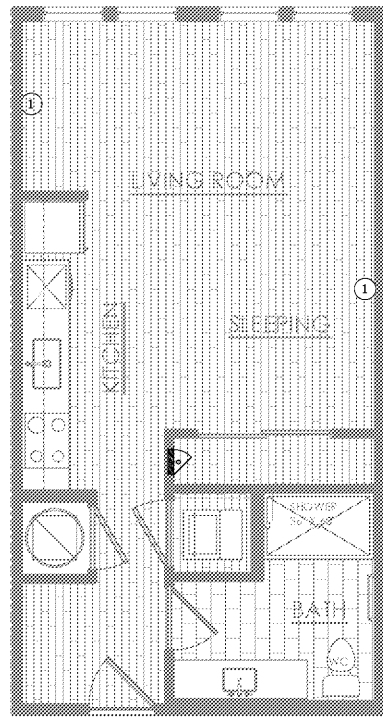

1 UNIT S1
14'4" x 12'

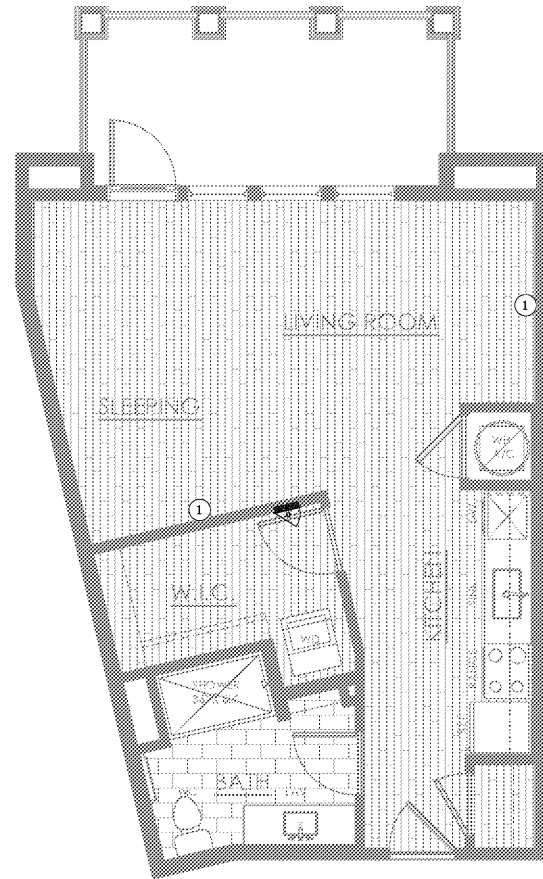

2 UNIT S2
14'4" x 12'

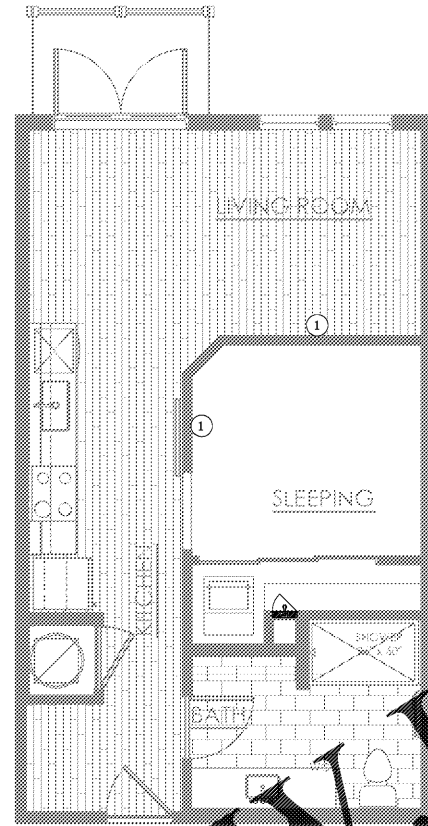

3 UNIT A1
14'4" x 12'

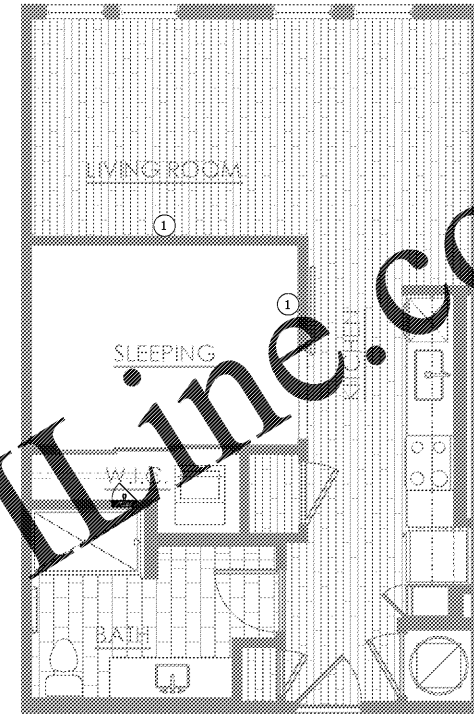

4 UNIT A2
14'4" x 12'

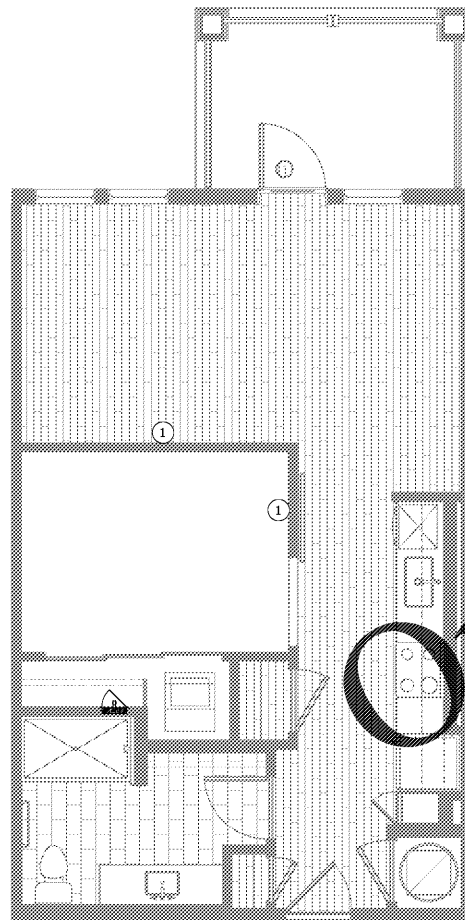

5 UNIT A2.1
14'4" x 12'

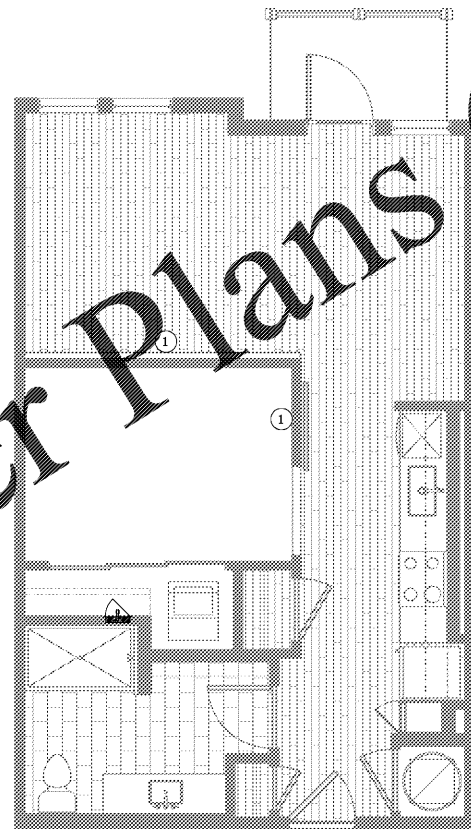

6 UNIT A2.2
14'4" x 12'

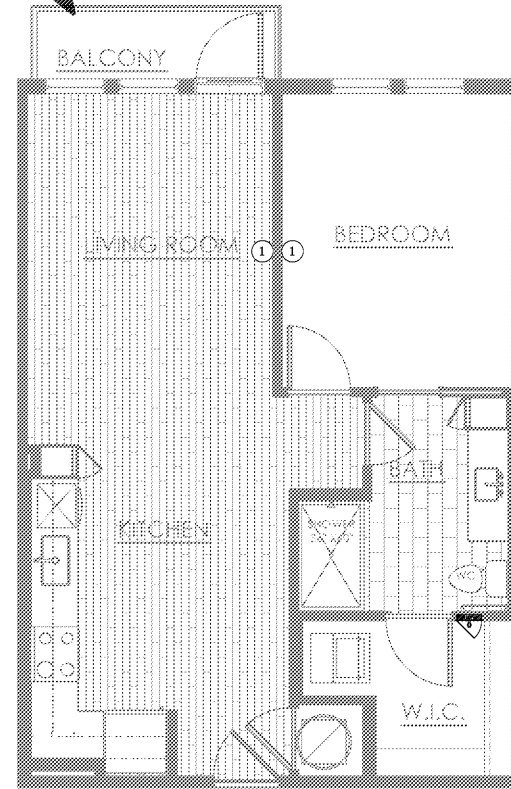

7 UNIT A3
14'4" x 12'

Order Plans @ WWW.LDILLINE.COM

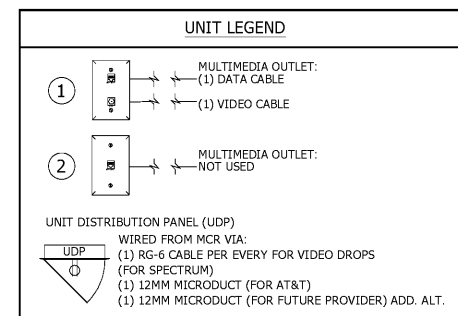

INFINISYS
MULTIFAMILY TECHNOLOGY
1825 Business Park Blvd, Suite C
Daytona Beach, FL 32114 USA
386-235-1500
E-Mail: cap@infms.com

NOTICE: This drawing is the property of INFINISYS. All information that is not generally known shall be confidential except to the extent the information has been previously established. This drawing may not be reproduced, copied, or used as the basis for manufacture or sale without written permission. This design uses architectural CAD drawings provided by charlan brock associates for this project and are used with their permission.

Copyright 2019 Infnisys. All rights reserved.

Lyric at Norton Commons
Prospect, Kentucky

Bristol Development Group
381 MacIlroy Station Rd, Suite 204
Franklin, TN 37067

c b a
charlan • brock
associates

architects • planners

1770 fennell street
maitland florida 32751-7208
407.660.8900 f:407.875.9948
www.cbaarchitects.com

LOW VOLTAGE
UNIT PLANS:

date: 01-11-2019
job no: 3789.15
drawn by: G.UBIENSKI
reviewed by: T.STENDER
issue history:
Δ Date

SCHEMATIC SET

Charlan Brock & Associates, Inc. hereby reserves its common law copyright and other property rights in these plans, ideas, and designs. These ideas, designs, and plans are not to be reproduced, changed or copied in any form or manner whatsoever, nor are they to be assigned to any third party, without first obtaining the express written permission from C.B.A., Inc. within dimensions that have precedence over scale dimensions.